

CATALOGO GENERALE _1

AZIENDA
COMPANY

CRISTALMOOD

TOP
TOPS

TOP SCATOLATI
SUSPENDED TOPS

LAVABI D'ARCHITETTURA
ARCHITECTURE SINKS

LAVABI FREESTANDING
FREESTANDING SINKS

LAVABI
SINKS

COLLAGE

SPECCHI E ILLUMINAZIONE
MIRRORS AND LIGHTING



antoniolupi

MADE IN ITALY

L'eccellenza nel bagno ha un'anima toscana
Excellence in the bathroom has a Tuscan soul

antoniolupi

MADE IN ITALY

welcome to
antoniolupi



**CATALOGO
GENERALE
VOL.1**

antoniolupi



Una storia fatta di coraggio e passione, di intuizioni e costanza, di individualità e partecipazione.

A story of courage and passion, intuition and consistency, individuality and participation.





Una storia fatta di coraggio e passione, di intuizioni e costanza, di individualità e partecipazione, in una sola parola di visione. La visione non è mai mancata nella storia di quella che oggi è antoniolupi ma che molti anni fa nasceva dall'intuito di Antonio Lupi, il padre dei quattro fratelli che oggi guidano l'azienda. Come tutte le storie di successo non è stato un percorso semplice, tutt'altro, è stato un cammino tortuoso, fatto di tappe importanti, di parziali cadute, di riprese, di consolidamento, di affermazione. Una storia basata sulle idee, quelle giuste, spesso vincenti, sempre innovative.

Antonio Lupi, nato a Vinci, il paese di Leonardo, inizia nel 1950 la sua attività in un piccolo magazzino di Fucecchio, a pochi chilometri dall'attuale sede di Stabbia. A soli 18 anni avvia la produzione di cristalli e vetri per l'arredo; è un momento di svolta per una famiglia di origine contadina, una vera rivoluzione in un territorio, quello della Val d'Arno, nel quale le attività tipiche interessavano settori molto diversi.

Antonio inizia a proporre ai suoi clienti i suoi primi prodotti, dai ripiani per comodino alle prime vetrinette e si costruisce una piccola rete commerciale. Dai vetri agli specchi per il bagno il passo è breve, anche se complicato. Siamo negli anni 60, gli anni del boom economico che ha radicalmente cambiato il volto del nostro paese e ha avviato una radicale trasformazione delle tipologie dell'abitare, con il passaggio epocale dal bagno in comune, alla stanza privata presente in ogni casa. Il successo è immediato e l'azienda si espande rapidamente trasformandosi da terzista in produttore di arredo bagno con il nome di Cristal Lupi Luxor.

Nel 1969 la Cristal Lupi Luxor apre a Stabbia il nuovo stabilimento. È il definitivo passaggio dalla dimensione artigianale a quella industriale, da Lupi arrivano a lavorare oltre 300 persone (quasi tutte di Stabbia o degli abitati vicini) e il radicamento tra l'azienda e il luogo si fa ancora più intenso, quasi indissolubile. Il successo dura per parecchi anni, l'offerta si amplia rapidamente comprendendo oltre agli specchi anche lampade, piccoli accessori e perfino accappatoi. All'inizio degli anni 80 in una situazione di mercato molto cambiata e con l'azienda che ha difficoltà ad adeguarsi al nuovo che avanza, entra in azienda Andrea, Patrizia e Nello già sono in Azienda, la prima all'ufficio acquisti/gestione fornitori, l'altro alla consociata francese a Cannes, nata per presidiare il mercato francese (Sergio, il più piccolo, nato nel 1977, entrerà ovviamente molti anni dopo). Andrea girando per Clienti si rende conto che la direzione dell'Azienda che è ormai in crisi, non è più quella giusta e anche contro il parere di Antonio, riesce, con pochi investimenti a presentare al Cersaie del 1983 una piccola collezione di sistemi di arredo bagno. Il successo è immediato, è l'opportunità per ripartire...

I fratelli lo seguono, nasce la Gilly (nome ispirato ad un noto Caffè fiorentino), il padre per ora li guarda da lontano, non li segue subito, intuisce che i suoi figli stanno diventando grandi e hanno bisogno di "fare da soli". In realtà è troppo orgoglioso della sua creazione e non riesce ad abbandonare la nave anche quando è irrimediabilmente andata alla deriva. È testardo, come tutti in famiglia, e ci vuole un po' per convincerlo ma alla fine i figli lo fanno sentire importante, lo coinvolgono, lo rendono partecipe del progetto e lui si rimette in discussione, riparte da capo. Il suo nome conta ancora nel territorio, quello che ha fatto, per molti, non si cancella. Riparte viaggiando per proporre gli articoli della nuova Antonio Lupi... Siamo nel 1988 e da un paio d'anni l'azienda aveva cambiato nome in Antonio Lupi Collezione Bagno. Antonio ne è il Direttore Commerciale, Patrizia è saldamente all'Amministrazione, Nello e Andrea fanno tutto il resto. Il successo è rapido e costante e presto la nuova azienda ha bisogno di spazio. Nel 1991 Antonio Lupi torna a Stabbia, ricomprando parte dell'antica fabbrica nel frattempo andata all'asta. Si riparte da lì, dalla vecchia sede della produzione ma con nuovo slancio, nuove idee, nuove strategie. L'azienda cresce rapidamente e si svincola dai vincoli dettati dai produttori dei sanitari iniziando a presentare i primi lavabi e articolando la propria offerta. Parte da quello che sa fare meglio, dai lavabi in vetro integrati nel piano, ma già dopo pochi anni l'azienda è in grado di proporre la prima collezione di lavabi in ceramica dalle forme geometriche essenziali. È l'avvento del minimale che culminerà nel 2002 con la prima collezione in Corian® e con lo sviluppo dell'idea del bagno completo e sartoriale. Anche con l'avvento dei nuovi materiali l'azienda non dimentica quelli tradizionali come la pietra, il marmo, protagonisti di molte altre collezioni. Da allora è tutto un susseguirsi di innovazioni e di collezioni di successo, l'Azienda che ha sposato la ricerca della bellezza, della funzionalità e della sartorialità e ne ha fatto il suo dna, propone costantemente nuove linee e nuovi materiali anche frutto della sua ricerca interna, trasformando il concetto stesso di ambiente bagno. Nel 2007 a un anno dalla scomparsa di Antonio e della moglie Mara, viene rivisitato il logo aziendale. Un'operazione importante perché si è deciso di citare la grafica del marchio originario ma allo stesso tempo valorizzare l'affermazione di un brand che è oggi garanzia di qualità, bellezza, passione per l'ambiente bagno. Oggi antoniolupi mette a disposizione dei propri clienti tutto quanto concorre a dar vita a un total look elegante e raffinato, proprio come Antonio aveva sognato all'inizio della sua avventura. I suoi figli hanno realizzato il sogno e la storia può solo continuare...

A story of courage and passion, of intuition and perseverance, of individuality and participation, all summed up in a single word: vision. The vision has never lacked in the history of what today is antoniolupi, born many years ago from the intuition of Antonio Lupi, father of the four siblings whom lead the company today. Like all success stories, it was not a simple path, it was a tortuous journey made up of important stages, partial failures, come backs, consolidation and affirmation. A story based on ideas, the right ones, often victorious, always innovative.

Antonio Lupi, born in Vinci, the town of Leonardo, began his activity in 1950 in a small warehouse in Fucecchio, a few kilometers from the current headquarters of Stabbia. At the age of 18 he started the production of crystals and glass for furnishings; it is a turning point for a simple family, a real revolution in an area, that of the Val d'Arno, in which the typical business activities involved very different sectors.

Antonio begins to offer his customers his first products, from bedside shelves to the first showcases and a small sales network is built. From glass to bathroom mirrors is a short step, even if complicated. We are in the 60s, the years of the economic boom that has radically changed the face of our country and has started a radical transformation of dwellings, with the transformation of a shared bathroom to the private bathroom present in every home. The success is immediate and the company expands rapidly, transforming itself from a subcontractor into a bathroom furniture manufacturer with the name of Cristal Lupi Luxor.

In 1969 Cristal Lupi Luxor opens the new factory in Stabbia. It is the definitive transition from an artisanal dimension to industrial. More than 300 people come to work (almost all from Stabbia or from the nearby settlements) and rooting between the company and place becomes even more intense, almost indissoluble. Success lasts for several years, the offer expands rapidly including, in addition to mirrors, also lamps, small accessories and even bathrobes. At the beginning of the 80s, in a very changed market situation and with the company having difficulty in adapting to the new one that is advancing, Andrea, Patrizia and Nello begin working in the company. The first in the purchasing / supplier management office, the other to the French subsidiary in Cannes established to protect the French market (Sergio, the youngest, born in 1977, will obviously enter many years later). Andrea visiting clients realizes that the management of the company, now in crisis, is no longer the right approach and even against the opinion of Antonio, succeeds with little investments to present a small collection of furnishing systems at Cersaie in 1983. Success is immediate, it is the opportunity to start again ...

The siblings follow their father's footsteps and the company Gilly is born (name inspired by a well-known Florentine Caffè), for now the father watches from afar, he doesn't follow them immediately, he senses that his children are growing up and they need to "go at it alone". In reality he is too proud of his creation and is unable to abandon the ship even when he is irretrievably drifting. He is stubborn, like everyone else in the family, and it takes a while to convince him. Finally the children make their father feel important, they get him involved, they make him a participant in the project and he gets back into the discussion, starting over again. His name still counts in the territory, what he did for many cannot be erased. He starts traveling again to propose articles of the new Antonio Lupi ... We are in 1988 and for a couple of years the company had changed its name to Antonio Lupi Bath Collection. Antonio is its Commercial Director, Patrizia is firmly in Administration, Nello and Andrea do the rest. Success is rapid and constant and soon the new company needs space. In 1991 Antonio Lupi returns to Stabbia, buying back part of the old factory that had gone to auction. It starts from there, from the old production site but with new impetus, new ideas, new strategies. The company grows rapidly and frees itself from the constraints dictated by the manufacturers of sanitary ware, starting to present the first sinks and articulating its offer. It starts from what it does best, from glass sinks integrated into the top, but after just a few years the company is able to offer the first collection of ceramic sinks with essential geometric shapes. It is the advent of the minimal style that will culminate in 2002 with the first collection in Corian® and with the development of the idea of a complete and sartorial bathroom. Even with the arrival of new materials, the company does not forget the traditional ones such as stone and marble which are protagonists of many other collections. Since then it is a series of innovations and successful collections, the Company that has embraced the search for beauty, functionality and tailoring has made it its DNA, constantly proposes new lines and new materials, also the result of internal research, transforming the concept of the bathroom environment. In 2007, one year after the death of Antonio and his wife Mara, the company logo is revisited. An important operation because it was decided to mention the graphics of the original brand but at the same time enhance the affirmation of a brand that is today a guarantee of quality, beauty and passion for the bathroom. Today antoniolupi makes available to its customers everything that contributes to giving life to an elegant and refined total look, just as Antonio had dreamed at the beginning of his adventure. His children realized the dream and the story can only continue ...





IS BEAUTY A VALID CRITERION FOR TRUTH?





IL CRITERIO DELLA VERITÀ È LA BELLEZZA

LA PIETRA E IL FUOCO



showroom





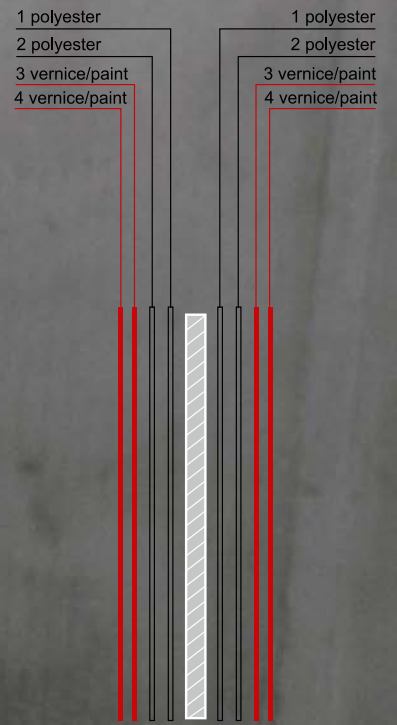
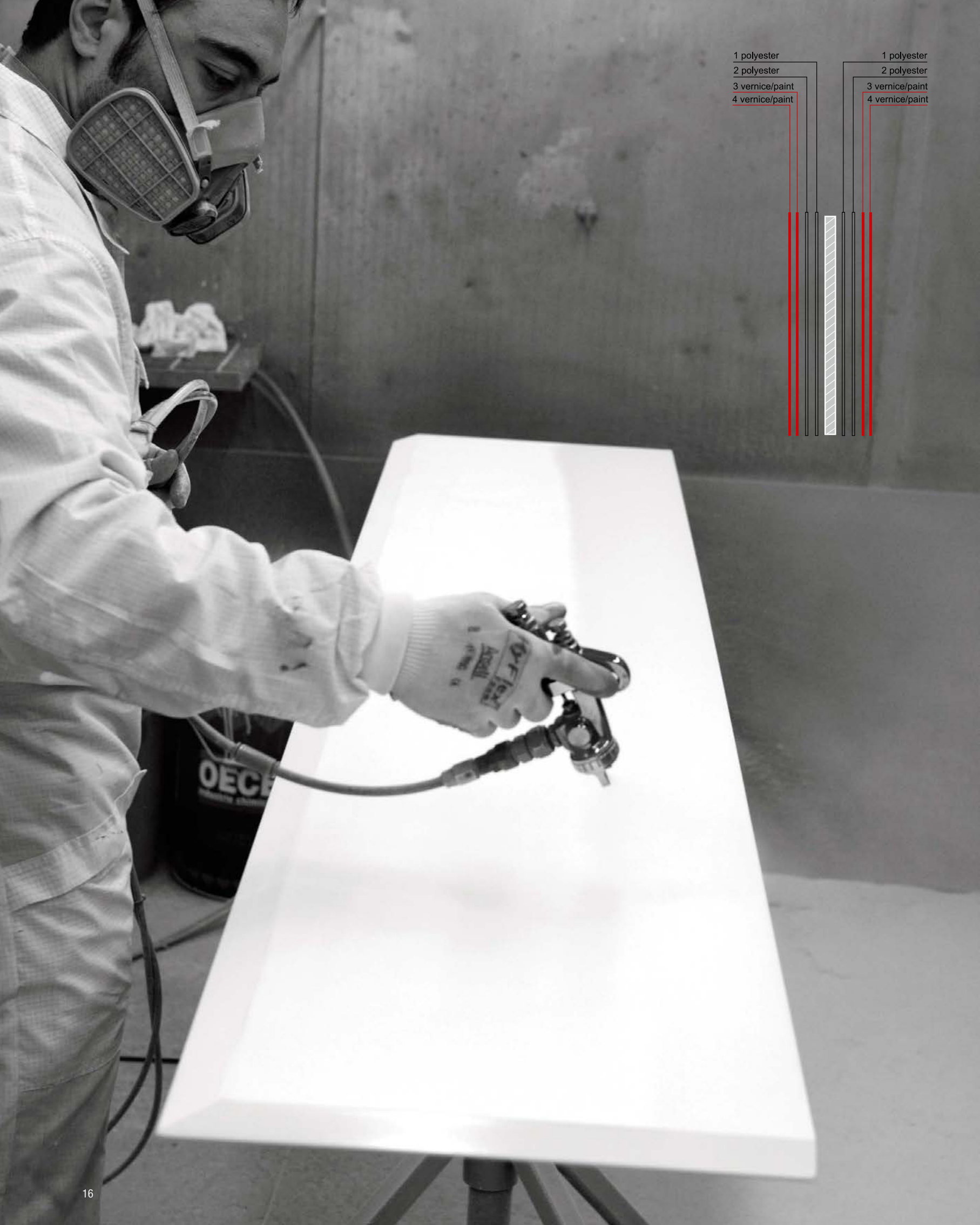



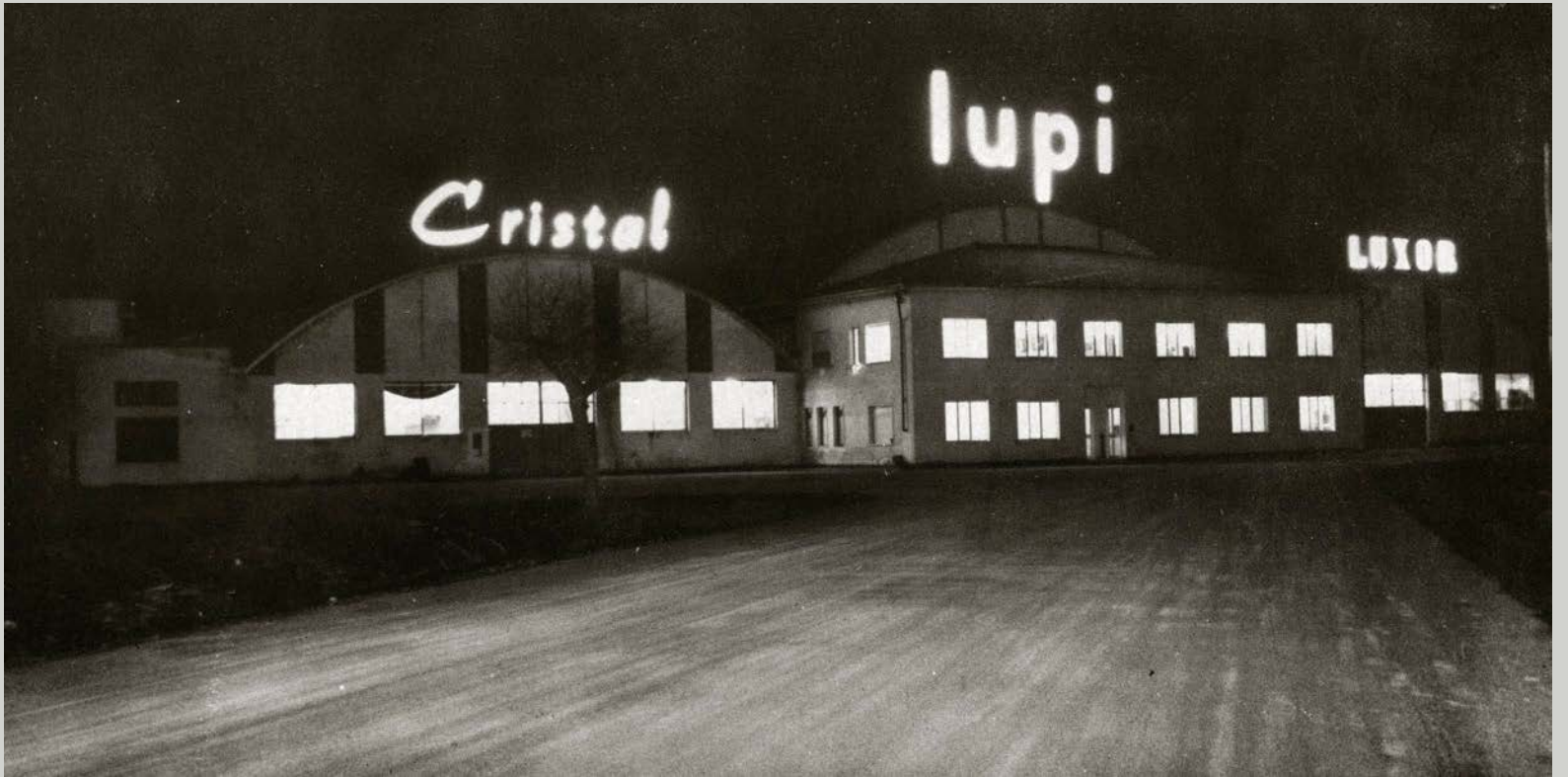
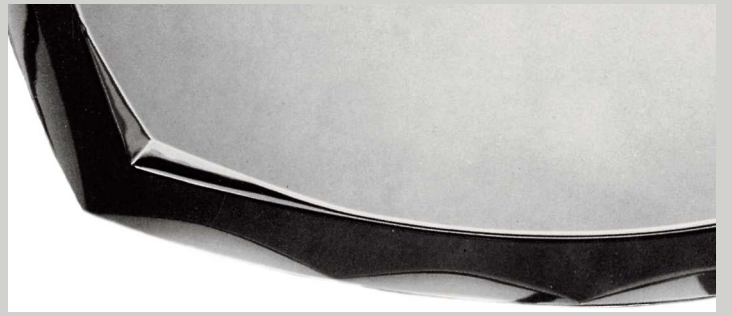
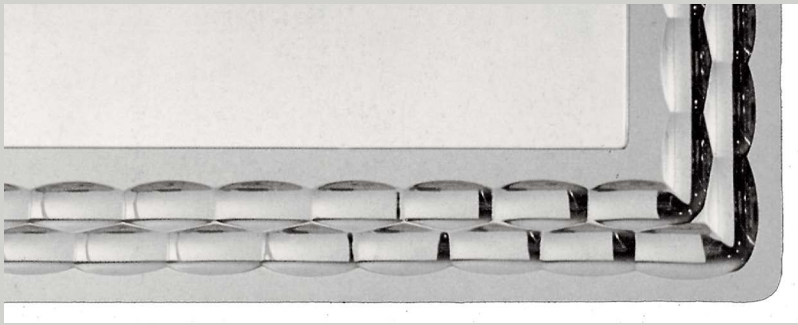

L'azienda negli anni '60.
The company in the '60's.



Antonio Lupi fotografato nel suo ufficio e mentre ritira un premio nel 1972.
Antonio Lupi photographed in his office and while receiving an award in 1972.



Patrizia, Nello, Sergio, Andrea

Completamente ricostruito, ampliato e rinnovato, dopo l'uragano che lo aveva distrutto nel 2014, lo showroom aziendale si presenta con una esposizione di ben 3300 metri quadrati, completata da una grande sala riunioni che accoglie i visitatori nelle molteplici attività programmate durante l'anno, dalla mostra al convegno, alla presentazione di prodotti fino al pranzo o alla cena.

Lo showroom è visitabile tutto l'anno su prenotazione.

Completely rebuilt, expanded and renovated after the hurricane that had destroyed it in 2014, the company showroom has an exhibition space of 3300 square meters completed by a large meeting room that welcomes visitors in the many activities planned during the year, from exhibition to meetings, to the presentation of products as well as lunch or dinner.

The showroom can be visited throughout the year upon reservation.







Collezione antoniolupi
Opere a tema architettonico di BENIAMINO SERVINO

antoniolupi collection
Themed architectural works by BENIAMINO SERVINO



SHOWROOM
LA PIETRA E IL FUOCO

antoniolupi



LO SHOWROOM DI MILANO

MILAN SHOWROOM

Nel 2018 lo showroom antoniolupi di Porta Tenaglia ha raddoppiato i suoi spazi che sono stati ripensati da Calvi e Brambilla per una presenza importante in una Milano sempre più internazionale. Concentrandosi sulla particolare conformazione dello spazio, il piano terra di una elegante torre progettata negli anni '50 dagli architetti Baselli e Portaluppi, gli architetti hanno deciso di lavorare sulla scatola architettonica dello showroom. Lo spazio che si sviluppa soprattutto in lunghezza, evoca la sequenza di tante sale da bagno che l'una dopo l'altra, si offrono allo sguardo per essere ammirate, anche dall'esterno delle quattordici vetrine a tutta altezza. Il nuovo soffitto, costituito da volte architettoniche volutamente irregolari e 'appese' al fondo scuro, regala profondità a tutto lo showroom. Volutamente gli archi non coincidono né con gli spazi né con le vetrine. Un gesto di libertà rispetto a certe simmetrie spaziali.

Showroom Antonio Lupi, Piazza Lega Lombarda, Milano, 2018.

In 2018 the antoniolupi showroom in Porta Tenaglia has doubled its spaces, which have been redesigned by Calvi and Brambilla for an important presence in an increasingly international Milan. Focusing on the particular shape of the space, the ground floor of an elegant tower designed in the 1950s by architects Baselli and Portaluppi, the architects decided to work on the architectural box of the showroom. The space that develops above all in length, evokes the sequence of many bathrooms that one after the other offer themselves to be admired, even from the outside of the fourteen full-height windows. The new ceiling, consisting of deliberately irregular architectural vaults and "hung" to the dark background gives depth to the whole showroom. The arches intentionally do not coincide either with the spaces or with the windows. A gesture of freedom with respect to certain spatial symmetries.

Showroom Antonio Lupi, Piazza Lega Lombarda, Milano, 2018.





Resistente come la pietra, trasparente come il cristallo.
Resistant as stone, clear as crystal.

Il Cristalmood è una resina di nostra creazione che viene colata manualmente negli stampi. Gli oggetti una volta estratti, devono essere rifiniti manualmente mediante carteggiatura per togliere tutte le imperfezioni sia all'interno che all'esterno. Come se fosse di pietra, ogni prodotto risulta così unico, le leggere differenze di colore, di dimensione, o le piccole bolle d'aria che possono formarsi, danno anima e autenticità ad ogni oggetto.

Cristalmood is a resin of our own creation that is manually poured into molds. Once extracted, the objects must be finished manually by sanding them to remove all imperfections both inside and out. As if it were made of stone, each product is unique, the slight differences in color, size, or small air bubbles that can form, give soul and authenticity to each object.

CRISTALMOOD

Le fasi della lavorazione del CRISTALMOOD sono abbastanza complesse, l'intervento manuale e la sapienza artigianale sono essenziali, infatti gli oggetti appena estratti dagli stampi in silicone appaiono grezzi come si può osservare dalle foto.

The processing stages of CRISTALMOOD are quite complex, manual intervention and craftsmanship are essential, in fact the objects just extracted from silicone molds appear rough as it can be seen from the images.





Una volta che la resina si è solidificata, si procede alla carteggiatura e alla lucidatura che vengono eseguite manualmente in modo da togliere le imperfezioni e dare brillantezza all'oggetto. La fase finale consiste poi in un fissativo di protezione.

Once the resin has solidified, we proceed to the sanding and polishing which are carried out manually in order to remove the imperfections and give brightness to the object. The final stage consists then in a protective fixative.







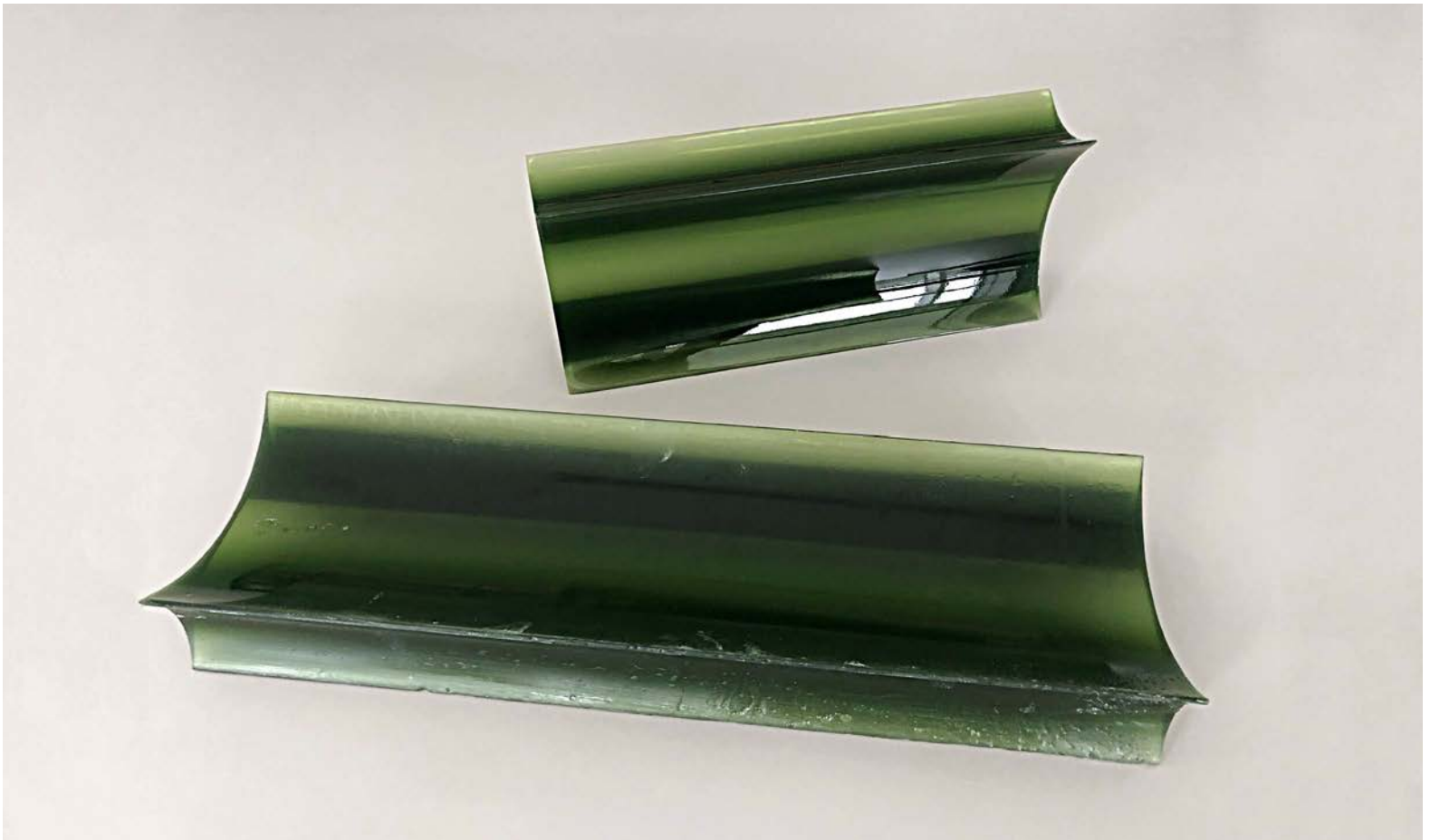

CRISTALMOOD

Dato il tipo di lavorazione e l'artigianalità della produzione, ogni oggetto in Cristalmood è unico e irripetibile, due lavabi non potranno mai essere identici, per leggere differenze di colore, di dimensione, di spessore!

Due to the type of processing and the craftsmanship of the production, each product made of Cristalmood is unique and unrepeatable, two sinks won't never be identical, for slight differences in color, size, and thickness.





fumé



CRISTALMOOD

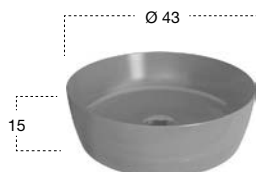
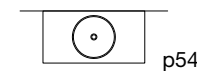
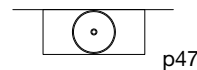

H	Ø	art.
15	43	CATINO43C

Lavabo tondo sopra piano in Cristal mood, disponibile in diversi colori come da nostro campionario completo di pileta con scarico libero e raccordo per sifone.

Round top mount sink in Cristal mood, available in various colors complete with drain pipe fitting and open plug.



fumé

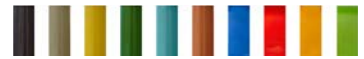
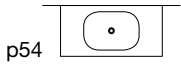
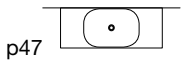
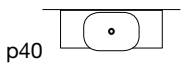

CRISTALMOOD

H	P	L	art.
15	40	60	SENSOC

Lavabo rettangolare sopra piano in Cristalmood, disponibile in diversi colori come da nostro campionario, completo di pileta con scarico libero e raccordo per sifone.

Rectangular top mount sink in Cristalmood, available in various colors complete with drain pipe fitting and open plug.







ginger



CRISTALMOOD

H	Ø	art.
16	50	OPALE10

Lavabo decagonale in Cristalmood disponibile in diversi colori come da nostro campionario, sopraiano o abbinabile con colonna Art. OPALE20 o Art. OPALE21, completo di piletta con scarico libero e raccordo per sifone.

Decagonal shape sink in Cristalmood available in various colors as per our color chart, to be used top mount or combined with base Art. OPALE20 or Art. OPALE21, complete with drain pipe fitting and open plug.

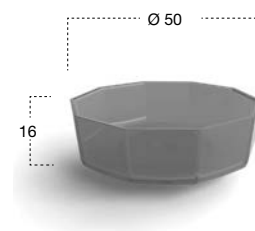

OPALE

_2019

design

Carlo Colombo

Andrea Lupi

Il nome rimanda in maniera esplicita alla geometria e agli infiniti riflessi delle pietre preziose, la magia unica della natura invade l'ambiente bagno in un continuo rimando tra materia, superfici e cromatismi raffinati. Opale è la collezione di lavabi con la quale antoniolupi prosegue quel percorso di ricerca avviato con Albume sulle potenzialità del Cristalmood colorato e sulle sue capacità di dialogare con i materiali naturali che sono da sempre nel dna dell'azienda.

L'aspetto cromatico della collezione è interpretato attraverso i 10 colori nei quali viene proposto il Cristalmood e dalla combinazione delle tonalità traslucide con l'unicità dei segni e delle venature irripetibili del Marmo Bianco Carrara o del Nero Marquina. Perché se è vero che quando è realizzato totalmente in Cristalmood il lavabo a colonna esprime compiutamente l'immagine sfaccettata di una gemma preziosissima nelle sue infinite variazioni cromatiche, le diverse soluzioni che prevedono l'accostamento di volumi realizzati in materiale diverso generano sensazioni del tutto nuove e esperienze inedite molto particolari.

In un caso il bacino traslucido sembra sostenuto con sicurezza e solidità quando viene accoppiato con la colonna in marmo, al contrario la sensazione di sospensione generata da un volume opaco sorretto da una colonna traslucida amplifica la magia della serie. Tutte le versioni proposte sono accomunate da un'immagine senza tempo, da un equilibrio geometrico e proporzionale perfetto che rimanda alla bellezza classica degli elementi architettonici che nel corso dei secoli hanno tramandato le forme archetipiche dell'architettura.

Il lavabo è disponibile nell'inedita forma decagonale o nella più tradizionale forma tonda, nella versione sopra piano, perfetto per abbinarsi con le altre proposte di antoniolupi, o a colonna, anch'essa cilindrica o prismatica.

The name refers explicitly to geometry and the infinite reflections of precious stones, the unique magic of nature invades the bathroom in a continuous cross-reference between material, surfaces and refined chromatism. Opale is a collection of washbasins through which antoniolupi continues its research, started with Albume collection, on the potential of colored Cristalmood and its ability to dialogue with natural materials that have always been in the company's DNA.

The chromatic aspect of the collection is interpreted through the 10 colors in which Cristalmood is proposed and the combination of the translucent shades with the uniqueness of the unrepeatable signs and veins of Bianco Carrara Marble or Nero Marquina. When it is totally made of Cristalmood, the pedestal sink fully expresses the multi-faceted image of a gemstone in its infinite chromatic variations. On the other hand, the different solutions that involve the combination of volumes made of different materials, generate entirely new sensations and very special unprecedented experiences.

The translucent basin seems to be supported with security and solidity when coupled with the marble pedestal, while, the suspended sensation generated by an opaque volume supported by a translucent pedestal amplifies the magic of the collection. All the versions proposed are characterized by a timeless image, by a perfect geometric and proportional balance which refers to the classic beauty of the architectural elements and that over the centuries have handed down the archetypal shapes of architecture.

The washbasin is available in the new decagonal shape or in the more traditional round shape, in the top mount version, and it is always perfectly matching with other products by antoniolupi. The same is also available as a freestanding pedestal washbasin that can be either cylindrical or prismatic.



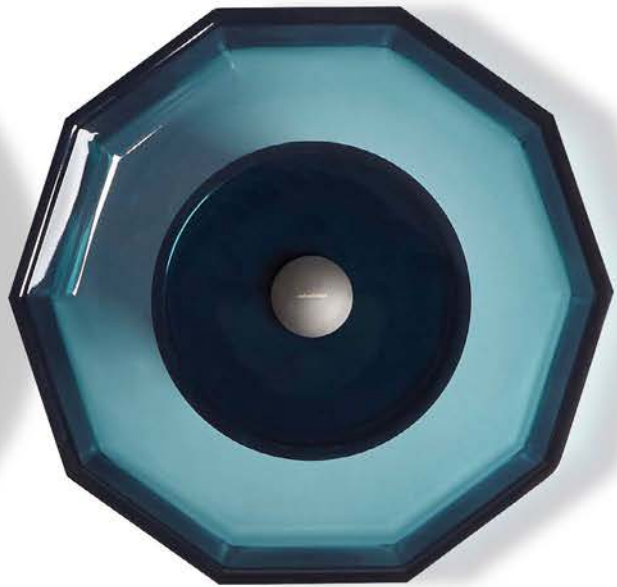



OPALE



nero marquina



petrolio / nero marquina



nero marquina / petrolio





fumé / nero marquinia

nero marquinia / fumé





petrolio

	H	Ø	art.
	16	50	OPALE10

Lavabo decagonale in Cristalmood, disponibile in diversi colori come da nostro campionario, sopraiano o abbinabile con colonna art. OPALE20 e art. OPALE21, completo di piletta con scarico libero e raccordo per sifone.

Decagonal sink in Cristalmood, available in various colors, top mount or to be combined with pedestal art. OPALE20 and art. OPALE21 complete with drain pipe fitting and open plug.

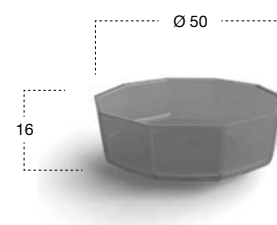

CRISTALMOOD

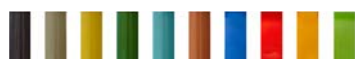

	H	Ø	art.
Marmo Carrara / Nero Marquinia	16	50	OPALE11

Lavabo tondo in pietra, sopraiano o abbinabile con colonna art. OPALE20 e art. OPALE21, completo di piletta con scarico libero e raccordo per sifone.

Round stone sink to be used top mount or with base art. OPALE20 or art. OPALE21 complete with drain pipe fitting and open plug.

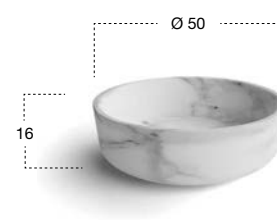

	H	Ø	art.
Cristalmood	70	30	OPALE20

Colonna da terra in Cristalmood, disponibile in diversi colori come da nostro campionario, con scarico a pavimento, sifone e tubo rigido.

Pedestal in Cristalmood available in various colors as per our samples, with floor drainage, siphon and rigid tube.

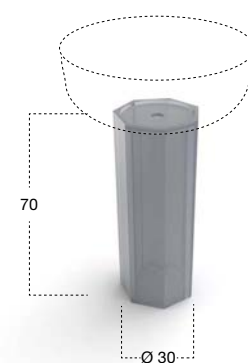

CRISTALMOOD



	H	Ø	art.
Marmo Carrara / Nero Marquinia	70	28	OPALE21

Colonna da terra in pietra con scarico a pavimento, sifone e tubo flessibile.

Pedestal in stone with floor drainage, siphon and flexible hose.

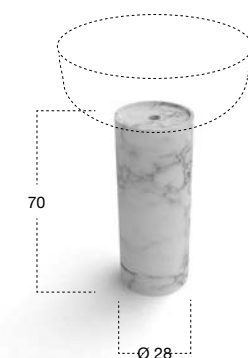

VITREO

_2019

design

Carlo Colombo

Andrea Lupi

Non più due parti distinte e sovrapposte come per Opale ma un unico blocco in Cristalmood che senza soluzione di continuità esprime tutta l'eleganza del materiale e la geometria classica delle forme del lavabo. Disponibile in 10 colori, Vitreo si inserisce con eleganza in diversi contesti di stile, donando luminosità allo spazio, grazie agli infiniti riflessi generati dal dialogo con gli elementi architettonici, le superfici e gli arredi che lo compongono.

Una forma decagonale, un'immagine caratteristica che non toglie però all'acqua il ruolo di assoluta protagonista, anzi la esalta perché proprio la vista dell'elemento primordiale che viene raccolto nel capiente bacino cambia la percezione del lavabo nel suo complesso.

Vitreo è una gemma che viene riscoperta e impreziosisce il centro stanza o il cristallo che si arrocca alla parete, l'elemento che attrae lo sguardo ed esprime l'approccio contemporaneo al progetto di antoniolupi.

No longer two distinct and superposed parts, like Opale collection, but a single Cristalmood block that seamlessly expresses all the elegance of the material and the classic geometry of the sink shapes. Vitreo is available in 10 colors and it is able to fit different refined styles contexts. It is also providing a sense of brightness to the space thanks to the infinite reflections generated by the dialogue with the architectural elements, surfaces and furnishings that compose it.

A decagonal shape, a characteristic image that does not take out the leading role of water, rather it enhances it because the sight of the primordial element that is collected in the large basin changes the perception of the sink as a whole.

Vitreo is a rediscovered gem that embellishes the center of the room. It is the element that attracts the eye and expresses the contemporary approach to the project by antoniolupi.

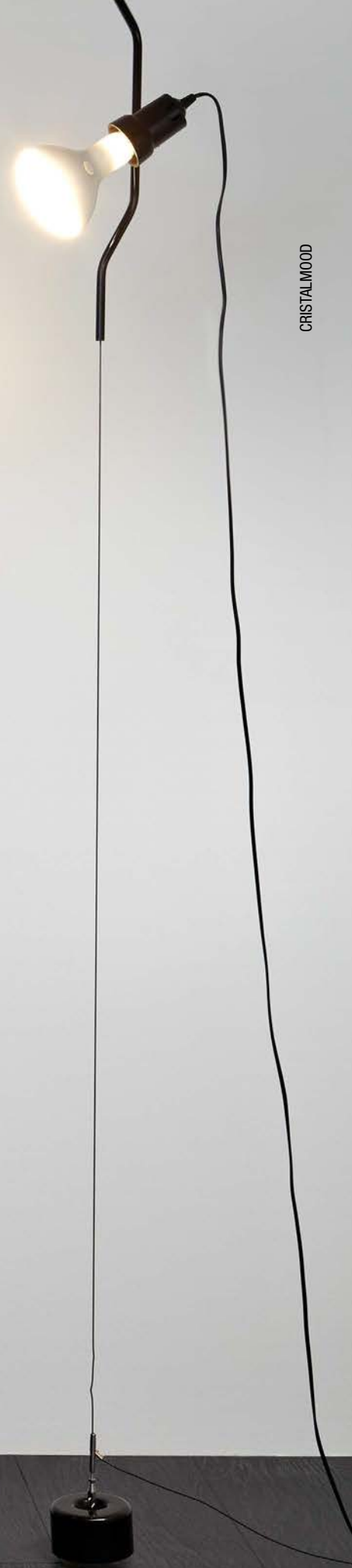

CRISTALMOOD







petrolio



ocra



nebbia



bottiglia



ginger



CRISTALMOOD

	H	Ø	art.
Cristalmoood	85	50	VITREO

Lavabo da terra in Cristalmoood con scarico a pavimento, disponibile in diversi colori come da nostro campionario, completo di piletta con scarico a libero, sifone e tubo rigido.

Freestanding Cristalmoood sink with floor drainage, available in various colors as per our color samples, complete with open plug, siphon and rigid tube.

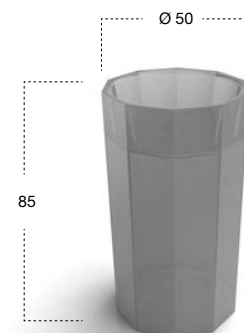

ALBUME

_2018

design
Carlo
Colombo

Leggerezza e solidità, rigore ed espressività, materia e colore. La poetica degli opposti, l'equilibrio che nasce dalla sovrapposizione di forme geometriche diverse, l'insieme che si manifesta solo nel rapporto proporzionale perfetto fra le parti. Albume è il lavabo freestanding disegnato da Carlo Colombo che vive dell'alternanza tra un basamento che esprime solidità e resistenza e un bacino trasparente e colorato che lascia all'acqua il ruolo di protagonista. Una nuova resina trasparente permette di realizzare la vasca del lavabo, disponibile in due forme differenti che definiscono un'immagine più slanciata o al contrario più morbida e accogliente. I raffinati contrasti cromatici tra i colori della parte superiore e le infinite declinazioni del marmo utilizzato per il basamento permettono di personalizzare il lavabo e conferire un carattere specifico all'insieme. Proprio in questo senso, Albume si inserisce perfettamente all'interno di ambienti bagno raffinati, nei quale i suoi materiali si armonizzano con le superfici e gli altri elementi della composizione dello spazio. La colonna realizzata in marmo Bianco Carrara o Nero Marquinia conferisce ancora più eleganza e prestigio al progetto per dialogare con rivestimenti, pavimenti o piani di lavoro.

Lightness and solidity, rigor and expressiveness, material and color. Poetry of opposites, the balance that arises from the superposition of geometric shapes, a perfect and proportional relationship between the parts. Albume is the freestanding washbasin designed by Carlo Colombo that alternates between a solid base that expresses strength and a transparent and colored basin that leaves water as the protagonist. A new transparent resin allows to create the basin of the sink, available in two different shapes that define a more slender image or on the contrary softer and welcoming. The refined color contrasts between the upper part and the infinite variations of the marble used for the base allow you to customize the sink and give a specific character to the whole. Precisely in this sense, Albume fits perfectly into refined bathrooms, in which its materials harmonize with the surfaces and other elements of the composition of the space. The base made in Bianco Carrara or Nero Marquinia marble to give more elegance and prestige to a project and to dialogue with walls, floors or work surfaces.







ALBUME



fumé / nero marquina





fumé / marmo carrara



CRISTALMOOD







ambra



cobalto



lime

CRISTALMOOD



bottiglia



nebbia



petrolio



sangria



ocra



ginger

ALBUME



nebbia / cobalto



nebbia / bottiglia



sangria / ginger



ginger / sangria

Albume è un progetto di lavabi versatile, oltre infatti alle versioni cristalmoood monocolori e cristalmoood combinato con marmo e legno, è disponibile anche nella versione cristalmoood bi-colore.

Albume is a versatile sink project, in addition to the cristalmoood monochrome and cristalmoood combined with marble and wood, it is also available in a two-color cristalmoood version.



petrolio / ocra



ambra / lime



petrolio / fumé



ginger / nebbia



bottiglia / lime



cobalto / petrolio



petrolio / cobalto



bottiglia / sangria



nebbia / ginger



ginger / ambra



lime / bottiglia



sangria / bottiglia



H	Ø	art.
20,5	48	ALBUME10

Lavabo tondo in Cristalmoood, disponibile in diversi colori come da nostro campionario, sopraiano o abbinabile con colonna art. ALBUME20, art. ALBUME21 e art. ALBUME30, completo di piletta con scarico libero e raccordo per sifone.

Round sink in Cristalmoood, available in various colors, top mount or to be combined with pedestal art. ALBUME20, art. ALBUME21 and art. ALBUME30 complete with drain pipe fitting and open plug.

CRISTALMOOD

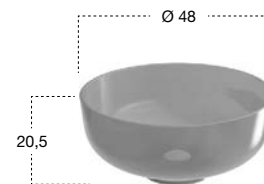

H	Ø	art.
20,5	48	ALBUME11

Lavabo tondo in Cristalmoood, disponibile in diversi colori come da nostro campionario, sopraiano o abbinabile con colonna art. ALBUME20, art. ALBUME21 e art. ALBUME30, completo di piletta con scarico libero e raccordo per sifone.

Round sink in Cristalmoood, available in various colors as per our samples, top mount or to be combined with pedestal art. ALBUME20, art. ALBUME21 and art. ALBUME30 complete with drain pipe fitting and open plug.

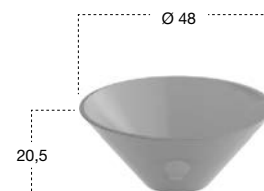

H	Ø	art.
65,5	28	ALBUME20

Colonna da terra in Cristalmoood o in resina verniciata gofrata, disponibile in diversi colori come da nostro campionario, con scarico a pavimento, sifone e tubo rigido.

Pedestal in Cristalmoood or embossed lacquered resin available in various colors as per our samples, with floor drainage, siphon and rigid tube.

CRISTALMOOD

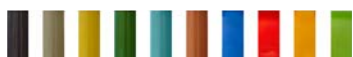

Verniciato esternamente in tutti i colori del nostro campionario
Can be externally lacquered in all colors of our collection

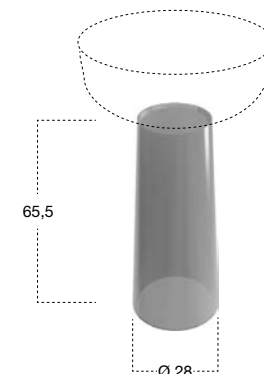

H	Ø	art.
65,5	28	ALBUME21

Colonna da terra in pietra con scarico a pavimento, sifone e tubo flessibile.

Pedestal in stone with floor drainage, siphon and flexible hose.

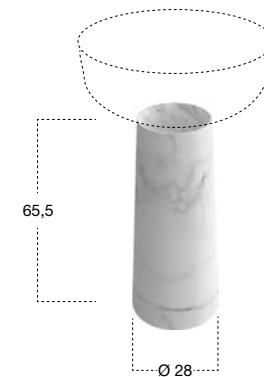

H	Ø	art.
65,5	28	ALBUME30

Colonna da terra in legno con scarico a pavimento, sifone e tubo flessibile.

Pedestal in wood with floor drainage, siphon and flexible hose.

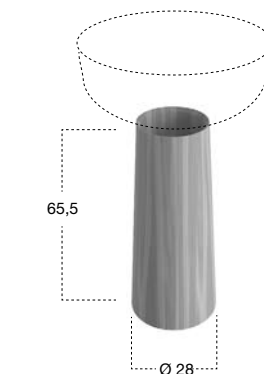



TOP
TOPS

TOP
TOPS

FLUMOOD

_2015

L'evoluzione tecnologica ci permette di poter usare nuovi materiali dalle caratteristiche straordinarie.

FLUMOOD è un materiale di nuova generazione, ecologico, compatto, non poroso, uniforme, atossico, con una superficie facilmente pulibile con i comuni prodotti per la pulizia domestica; inoltre può essere ripristinato semplicemente anche in caso di graffi o segni derivanti dall'uso quotidiano. Un materiale perfetto quindi per poter essere utilizzato nell'ambiente bagno.

antoniolupi, sicura della soddisfazione dei propri clienti, ha deciso di impiegarlo in alcuni suoi progetti di top e lavabi per i quali si è rivelato ideale sia nella finitura Satin che in quella Texture.

Technological evolution allows us to be able to use new material with extraordinary characteristics.

FLUMOOD is an innovative material, ecological, compact, non-porous, uniform, non-toxic with a surface easy to clean with common cleaning products; can be restored when scratched caused by everyday use. A perfect material for the bathroom.

antoniolupi is sure that customers will be completely satisfied and has decided to use this material in their projects concerning tops and sinks proved ideal in either the Satin or Textured finish.

Due finiture

Two finishes

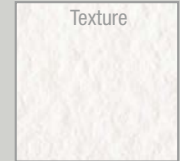
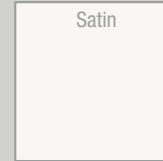

Il perché della scelta di un nuovo materiale...

The reason for choosing a new material...

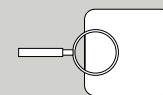

ANTIBATTERICO
ATOSSICO
ANTIBACTERIAL
NON TOXIC

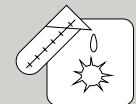

RESISTENTE ALLE
SOSTANZE CHIMICHE
RESISTANT TO
CHEMICALS



IGNIFUGO
FIREPROOF



VERNICIABILE
PAINTABLE

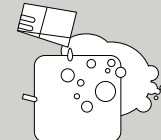

IDROREPELENTE
WATER REPELLENT

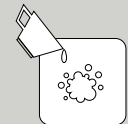

ANTIMACCHIA
STAIN RESISTANT



SOLIDO
SOLID



ECOLOGICO
ECOLOGICAL



LUNGA DURATA
LONG LIFE

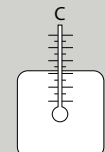

RESISTENTE ALLE
VARIAZIONI DI TEMPERATURA
RESISTANT TO VARIATIONS
IN TEMPERATURE



OTTIMA RESISTENZA AI GRAFFI
E ALLE ABRASIONI
EXCELLENT RESISTANCE TO
SCRATCHES AND ABRASIONS



CARTEGGIABILE
COME IL LEGNO
SAND LIKE WOOD



TOP
TOPS

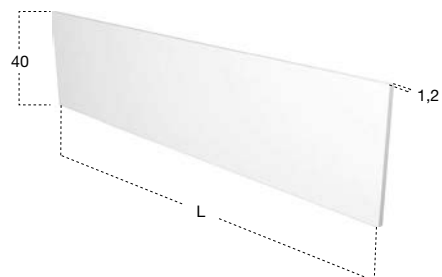

H	P	L	art.
40	1,2	da / from 54 a / to 272,4	BC140

Alzatina in Flumood in finitura Satin o Texture.

Flumood backsplash in Satin or Texture finish.



TOP
TOPS

Per collezione / For collection

ORMA - ATELIER - BESPOKE - PIANA - LUNARIA

H	P	L	art.
1,2	40	da / from 54 a / to 272,4	BC140
	47		BC147
	54		BC154

Per collezione / For collection

PANTA REI

H	P	L	art.
1,2	40	da / from 54 a / to 216	BC240
	47		BC247
	54		BC254

Per collezione / For collection

PLANETA

H	P	L	art.
1,2	40	da / from 54 a / to 216	BC340
	47		BC347
	54		BC354



Top in Flumood finitura Satin o Texture, spessore 12 mm.

Top in Flumood Satin or Texture finish, 12 mm thick.

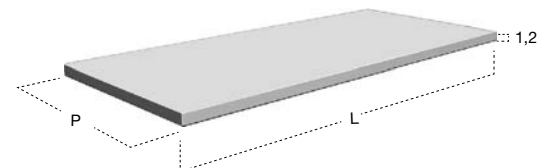





TOP
TOPS

OPTIONAL
Troppopieno
Overflow



Per collezione / For collection

ORMA - ATELIER - BESPOKE - PIANA - LUNARIA

H	P	L		art.
1,2	47	da / from 72	a / to 272,4	BC147 + BASIC047
	54			BC154 + BASIC054

Per collezione / For collection

PANTA REI

H	P	L		art.
1,2	47	da / from 72	a / to 216	BC247 + BASIC047
	54			BC254 + BASIC054

Per collezione / For collection

PLANETA

H	P	L		art.
1,2	47	da / from 72	a / to 216	BC347 + BASIC047
	54			BC354 + BASIC054

Art. BASIC047 - BASIC054

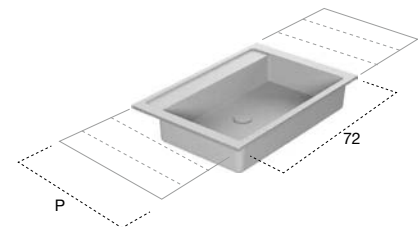

+

Art. BC147 - BC247 - BC347
Art. BC154 - BC254 - BC354

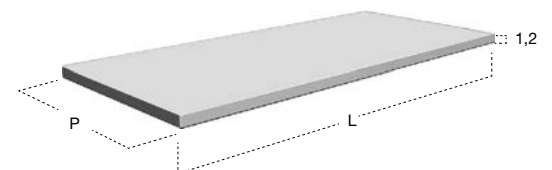

Top con lavabo integrato sopra piano in Flumood in finitura Satin, spessore 12 mm completo di piletta con scarico libero e raccordo per sifone.

N.B. solo per porta lavabi H 37,5 e H 50 cm. Nei porta lavabi H 37,5 è possibile inserire solo sifone art. MICRO.

Top with integrated sink in Flumood Satin finish, 12 mm thick, complete with drain pipe fitting and open plug.
P.S. only for sink units cm 37,5 and 50 H. In sink units cm 37,5 H it is only possible to use siphon art. MICRO.





TOP
TOPS

OPTIONAL
Troppopieno
Overflow



Per collezione / For collection				
ORMA - ATELIER - BESPOKE - PIANA - LUNARIA				
H	P	L	art.	
1,2	47	da / from 144	a / to 272,4	BC147 + n° 2 BASIC047
	54			BC154 + n° 2 BASIC054
Per collezione / For collection				
PANTA REI				
H	P	L	art.	
1,2	47	da / from 144	a / to 216	BC247 + n° 2 BASIC047
	54			BC254 + n° 2 BASIC054
Per collezione / For collection				
PLANETA				
H	P	L	art.	
1,2	47	da / from 144	a / to 216	BC347 + n° 2 BASIC047
	54			BC354 + n° 2 BASIC054

Top con doppio lavabo integrato soprapiano in Flumood finitura Satin, spessore 12 mm, completo di piletta con scarico libero e raccordo per sifone.

N.B. solo per porta lavabi H 37,5 e H 50 cm. Nei porta lavabi H 37,5 è possibile inserire solo sifone art. MICRO.

Top with double integrated sink in Flumood Satin finish, 12 mm thick, with drain pipe fitting and open plug.
P.S. only for sink units cm 37,5 and 50 H. In sink units cm 37,5 H it is only possible to use siphon art. MICRO.

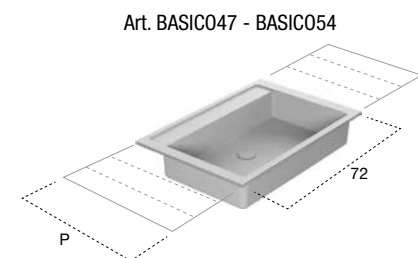

Art. BASIC047 - BASIC054

+

Art. BC147 - BC247 - BC347
Art. BC154 - BC254 - BC354

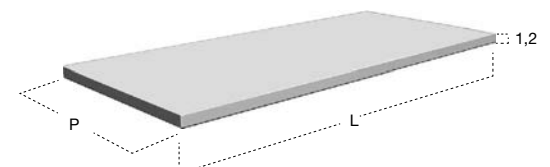





TOP
TOPS

Per collezione / For collection

ORMA - ATELIER - BESPOKE - PIANA - LUNARIA

art.

H	P	L			
1,2	40	da / from 54	a / to 272,4	BC140 + NIDO454	
	40	da / from 108	a / to 272,4	BC140 + n° 2 NIDO454	

Per collezione / For collection

PANTA REI

art.

H	P	L			
1,2	40	da / from 54	a / to 216	BC240 + NIDO454	
	40	da / from 108	a / to 216	BC240 + n° 2 NIDO454	

Per collezione / For collection

PLANETA

art.

H	P	L			
1,2	40	da / from 54	a / to 216	BC340 + NIDO454	
	40	da / from 108	a / to 216	BC340 + n° 2 NIDO454	

Top con singolo o doppio lavabo integrato in Flumood spessore 12 mm finitura Satin, completo di piletta con scarico libero e raccordo per sifone.

N.B. solo per porta lavabi H 37,5 e H 50 cm. Nei porta lavabi H 37,5 è possibile inserire solo sifone art. MICRO.

Top with single or double integrated sink in Flumood Satin finish 12 mm thick, with drain pipe fitting and open plug.

P.S. only for sink units cm 37,5 and 50 H. In sink units cm 37,5 H it is only possible to use siphon art. MICRO.

OPTIONAL
Pianetto copripiletta
Cover plate

Art. PIANETTO3

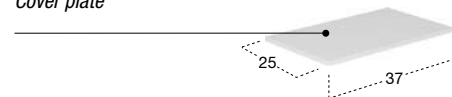

Art. NIDO454

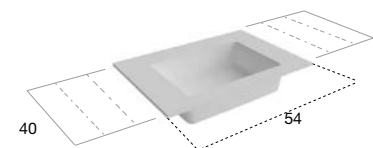

+

Art. BC140 - BC240 - BC340

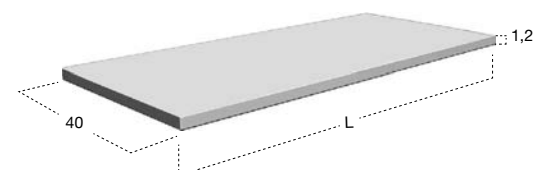



Art. NID054 - P 47

Per collezione / For collection

ORMA - ATELIER - BESPOKE - PIANA - LUNARIA

art.

H	P	L			art.
1,2	47	da / from 54	a / to 272,4		BC147 + NID054
	47	da / from 108	a / to 272,4		BC147 + n° 2 NID054

Per collezione / For collection

PANTA REI

art.

H	P	L			art.
1,2	47	da / from 54	a / to 216		BC247 + NID054
	47	da / from 108	a / to 216		BC247 + n° 2 NID054

Per collezione / For collection

PLANETA

art.

H	P	L			art.
1,2	47	da / from 54	a / to 216		BC347 + NID054
	47	da / from 108	a / to 216		BC347 + n° 2 NID054

Top con singolo o doppio lavabo integrato in Flumood spessore 12 mm finitura Satin, completo di piletta con scarico libero e raccordo per sifone.

N.B. solo per porta lavabi H 37,5 e H 50 cm. Nei porta lavabi H 37,5 è possibile inserire solo sifone art. MICRO.

Top with single or double integrated sink in Flumood Satin finish 12 mm thick, with drain pipe fitting and open plug.

P.S. only for sink units cm 37,5 and 50 H. In sink units cm 37,5 H it is only possible to use siphon art. MICRO.

OPTIONAL
Pianetto copripiletta
Cover plate

Art. PIANETTO1

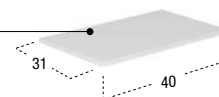

Art. NID054

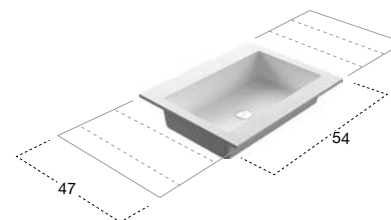

+

Art. BC147 - BC247 - BC347

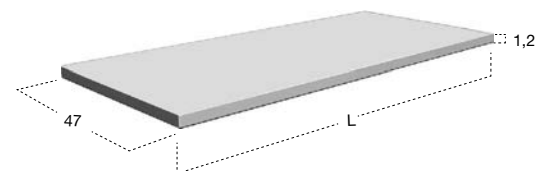

TOP
TOPS

Per collezione / For collection

ORMA - ATELIER - BESPOKE - PIANA - LUNARIA

art.

H	P	L			art.
1,2	47	da / from 72	a / to 272,4		BC147 + NID072
	47	da / from 144	a / to 272,4		BC147 + n° 2 NID072

Per collezione / For collection

PANTA REI

art.

H	P	L			art.
1,2	47	da / from 72	a / to 216		BC247 + NID072
	47	da / from 144	a / to 216		BC247 + n° 2 NID072

Per collezione / For collection

PLANETA

art.

H	P	L			art.
1,2	47	da / from 72	a / to 216		BC347 + NID072
	47	da / from 144	a / to 216		BC347 + n° 2 NID072

Top con singolo o doppio lavabo integrato in Flumood spessore 12 mm finitura Satin, completo di piletta con scarico libero e raccordo per sifone.

N.B. solo per porta lavabi H 37,5 e H 50 cm. Nei porta lavabi H 37,5 è possibile inserire solo sifone art. MICRO.

Top with single or double integrated sink in Flumood Satin finish 12 mm thick, with drain pipe fitting and open plug.

P.S. only for sink units cm 37,5 and 50 H. In sink units cm 37,5 H it is only possible to use siphon art. MICRO.

OPTIONAL
Pianetto copripiletta
Cover plate

Art. PIANETTO2

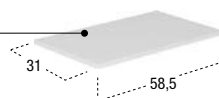

Art. NID072

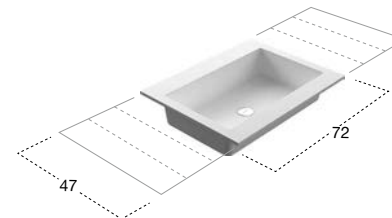

+

Art. BC147 - BC247 - BC347

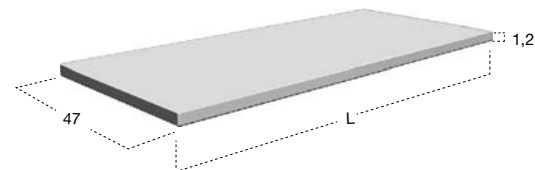



Per collezione / For collection

ORMA - ATELIER - BESPOKE - PIANA - LUNARIA

H	P	L	art.
1,2	54	da / from 54 a / to 272,4	BC154 + NIDO54
	54	da / from 108 a / to 272,4	BC154 + n° 2 NIDO54

Per collezione / For collection

PANTA REI

H	P	L	art.
1,2	54	da / from 54 a / to 216	BC254 + NIDO54
	54	da / from 108 a / to 216	BC254 + n° 2 NIDO54

Per collezione / For collection

PLANETA

H	P	L	art.
1,2	54	da / from 54 a / to 216	BC354 + NIDO54
	54	da / from 108 a / to 216	BC354 + n° 2 NIDO54

Top con singolo o doppio lavabo integrato in Flumood spessore 12 mm finitura Satin completo di piletta con scarico libero e raccordo per sifone.

N.B. solo per porta lavabi H 37,5 e H 50 cm. Nei porta lavabi H 37,5 è possibile inserire solo sifone art. MICRO.

Top with single or double integrated sink in Flumood Satin finish 12 mm thick, with drain pipe fitting and open plug.

P.S. only for sink units cm 37,5 and 50 H. In sink units cm 37,5 H it is only possible to use siphon art. MICRO.

Per collezione / For collection

ORMA - ATELIER - BESPOKE - PIANA - LUNARIA

H	P	L	art.
1,2	54	da / from 72 a / to 272,4	BC154 + NIDO72
	54	da / from 144 a / to 272,4	BC154 + n° 2 NIDO72

Per collezione / For collection

PANTA REI

H	P	L	art.
1,2	54	da / from 72 a / to 216	BC254 + NIDO72
	54	da / from 144 a / to 216	BC254 + n° 2 NIDO72

Per collezione / For collection

PLANETA

H	P	L	art.
1,2	54	da / from 72 a / to 216	BC354 + NIDO72
	54	da / from 144 a / to 216	BC354 + n° 2 NIDO72

Top con singolo o doppio lavabo integrato in Flumood spessore 12 mm finitura Satin, completo di piletta con scarico libero e raccordo per sifone.

N.B. solo per porta lavabi H 37,5 e H 50 cm. Nei porta lavabi H 37,5 è possibile inserire solo sifone art. MICRO.

Top with single or double integrated sink in Flumood Satin finish 12 mm thick, with drain pipe fitting and open plug.

P.S. only for sink units cm 37,5 and 50 H. In sink units cm 37,5 H it is only possible to use siphon art. MICRO.

OPTIONAL
Troppopieno
Overflow



OPTIONAL
Pianetto copripiletta
Cover plate

Art. PIANETTO1

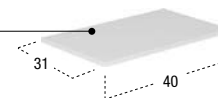

Art. NIDO54

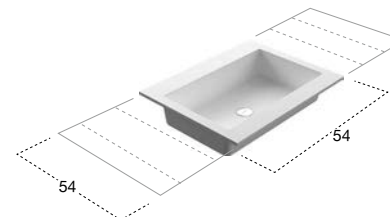

+

Art. BC154 - BC254 - BC354

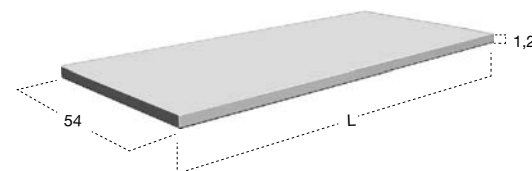

TOP
TOPS

OPTIONAL
Troppopieno
Overflow



OPTIONAL
Pianetto copripiletta
Cover plate

Art. PIANETTO2

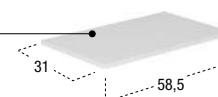

Art. NIDO72

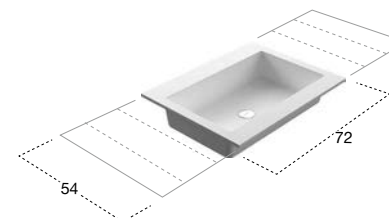

+

Art. BC154 - BC254 - BC354

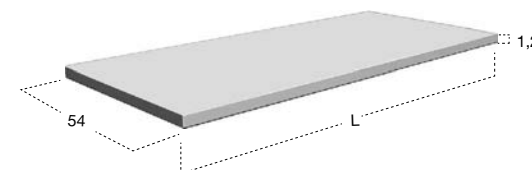





TOP
TOPS

Per collezione / For collection

ORMA - ATELIER - BESPOKE - PIANA - LUNARIA

art.

H	P	L		
1,2	47	da / from 72	a / to 272,4	BC147 + NUVOLA
	47	da / from 144	a / to 272,4	BC147 + n° 2 NUVOLA

Per collezione / For collection

PANTA REI

art.

H	P	L		
1,2	47	da / from 72	a / to 216	BC247 + NUVOLA
	47	da / from 144	a / to 216	BC247 + n° 2 NUVOLA

Per collezione / For collection

PLANETA

art.

H	P	L		
1,2	47	da / from 72	a / to 216	BC347 + NUVOLA
	47	da / from 144	a / to 216	BC347 + n° 2 NUVOLA

Top con singolo o doppio lavabo integrato in Flumood spessore 12 mm finitura Satin, completo di piletta con scarico libero e raccordo per sifone.

N.B. solo per porta lavabi H 37,5 e H 50 cm. Nei porta lavabi H 37,5 è possibile inserire solo sifone art. MICRO.

Top with single or double integrated sink in Flumood Satin finish 12 mm thick, with drain pipe fitting and open plug.

P.S. only for sink units cm 37,5 and 50 H. In sink units cm 37,5 H it is only possible to use siphon art. MICRO.

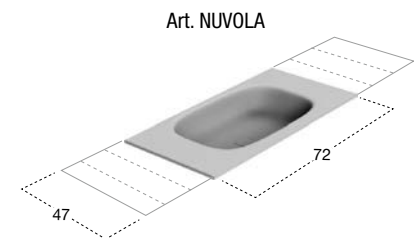

+

Art. BC147 - BC247 - BC347

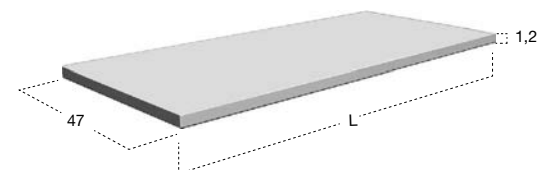





TOP
TOPS

OPTIONAL
Troppopieno
Overflow



Per collezione / For collection				
ORMA - ATELIER - BESPOKE - PIANA - LUNARIA				
H	P	L		art.
1,2	54	da / from 72	a / to 272,4	BC154 + NUVOLA
	54	da / from 144	a / to 272,4	BC154 + n° 2 NUVOLA
Per collezione / For collection				
PANTA REI				
H	P	L		art.
1,2	54	da / from 72	a / to 216	BC254 + NUVOLA
	54	da / from 144	a / to 216	BC254 + n° 2 NUVOLA
Per collezione / For collection				
PLANETA				
H	P	L		art.
1,2	54	da / from 72	a / to 216	BC354 + NUVOLA
	54	da / from 144	a / to 216	BC354 + n° 2 NUVOLA

Top con singolo o doppio lavabo integrato in Flumood spessore 12 mm finitura Satin, completo di piletta con scarico libero e raccordo per sifone.

N.B. solo per porta lavabi H 37,5 e H 50 cm. Nei porta lavabi H 37,5 è possibile inserire solo sifone art. MICRO.

Top with single or double integrated sink in Flumood Satin finish 12 mm thick, with drain pipe fitting and open plug.

P.S. only for sink units cm 37,5 and 50 H. In sink units cm 37,5 H it is only possible to use siphon art. MICRO.

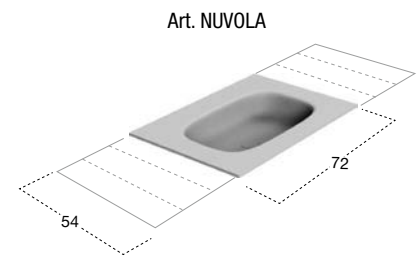

+

Art. BC154 - BC254 - BC354

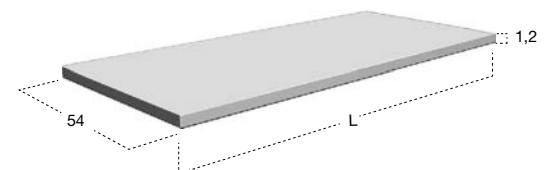

PODIO

_2015

design
Nevio
Tellatin



Podio presenta un bacino molto grande, dalla larghezza pressoché raddoppiata rispetto a un lavabo tradizionale. Viene proposto nelle finiture Satin e Texture e può essere caratterizzato da un pianetto copri pileta, sempre realizzato in Flumood, che divide di fatto il bacino, permettendo di passare facilmente da un lavabo singolo a uno doppio. Rimosso dal volume e posizionato sopra il top questo pratico ed elegante “rialzo” diventa una piccola mensola su cui posizionare accessori e strumenti per l’igiene personale. Un dettaglio sofisticato, un elemento funzionale che permette di accrescere la versatilità del lavabo.

Maximum capacity for Podio, presenting a very large basin, the width almost doubled compared to a conventional sink. Available in the Satin and Texture finishes and can be embellished by a shelf that also covers the drain and divides the basin in two allowing you to easily switch from a single sink to a double basin.

If placed on the surface, this practical and stylish “platform” becomes a small shelf on which to place personal care accessories. A sophisticated detail, a functional element that allows you to increase the versatility of the basin.



TOP
TOPS

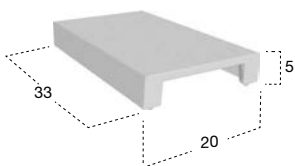

H	P	L	art.
5	33	20	PIANETTO

Pianetto optional copripiletta in Flumood finitura Satin.

Optional Flumood drain cover in satin finish.



TOP
TOPS

Per collezione / For collection				
ORMA - ATELIER - BESPOKE - PIANA - LUNARIA				
H	P	L	art.	
1,2	54	da / from 108	a / to 272,4	BC154 + PODIO
Per collezione / For collection				
PANTA REI				
H	P	L	art.	
1,2	54	da / from 108	a / to 216	BC254 + PODIO
Per collezione / For collection				
PLANETA				
H	P	L	art.	
1,2	54	da / from 108	a / to 216	BC354 + PODIO

OPTIONAL
Troppopieno
Overflow

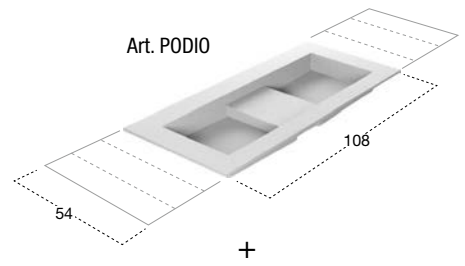
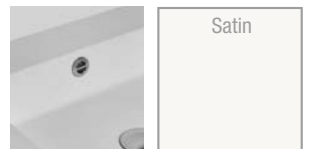

Art. BC154 - BC254 - BC354

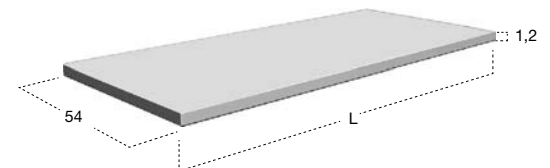

Top con lavabo integrato in Flumood in finitura Satin, spessore 12 mm completo di piletta con scarico libero e raccordo per sifone.

N.B. solo per porta lavabi H 37,5 e H 50 cm. Nei porta lavabi H 37,5 è possibile inserire solo sifone art. MICRO.

Top with integrated sink in Flumood Satin finish, 12 mm thick, complete with drain pipe fitting and open plug.
P.S. only for sink units cm 37,5 and 50 H. In sink units cm 37,5 H it is only possible to use siphon art. MICRO.

OPENSLOTMOOD

_2019

design
Nevio
Tellatin





TOP
TOPS



Per collezione / For collection				
ORMA - ATELIER - BESPOKE - PIANA - LUNARIA				
H	P	L	art.	
1,2	47	da / from 72	a / to 272,4	BC147 + OSM47
	54			BC154 + OSM54
Per collezione / For collection				
PANTA REI				
H	P	L	art.	
1,2	47	da / from 72	a / to 216	BC247 + OSM47
	54			BC254 + OSM54
Per collezione / For collection				
PLANETA				
H	P	L	art.	
1,2	47	da / from 72	a / to 216	BC347 + OSM47
	54			BC354 + OSM54

Art. OSM47 - OSM54

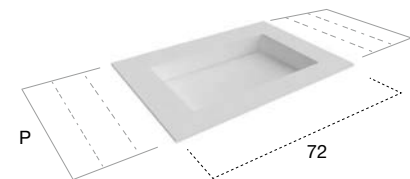

Art. BC147 - BC247 - BC347 - BC154 - BC254 - BC354

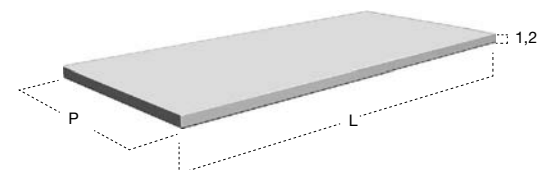

Top con lavabo integrato in Flumood finitura Satin, spessore 12 mm completo di piletta con scarico libero e raccordo per sifone.
N.B. solo per porta lavabi H 37,5 e H 50 cm. Nei porta lavabi H 37,5 è possibile inserire solo sifone art. MICRO.

Top with integrated sink in Flumood Satin finish, 12 mm thick, complete with drain pipe fitting and open plug.
P.S. only for sink units cm 37,5 and 50 H. In sink units cm 37,5 H it is only possible to use siphon art. MICRO.

BRECCIA

_2018

design
Mario
Ferrarini



Un segno forte ma delicato allo stesso tempo, un solco leggero ma evidente sulla superficie che ne connota l'identità, un dettaglio estetico che soddisfa una fondamentale esigenza funzionale, un'idea che risolve un aspetto tecnico e diventa tratto distintivo del progetto. Breccia è un lavabo tondo integrato al top in Flumood realizzabile su misura. La sua particolarità sta proprio nella risoluzione del tema dello scarico, da sempre oggetto di indagine e di ricerca da parte di antoniolupi. Prima azienda a eliminare la piletta tradizionale proponendo soluzioni eleganti e integrate nel design dell'elemento, oggi ha pensato per Breccia a un taglio che permette di defluire l'acqua, un segno che parte da un foro e proprio nel solco che scava nella materia ha il suo continuum che lo collega al perimetro del lavabo.

A strong but delicate mark at the same time, a light but evident groove on the surface that characterizes its identity, an aesthetic detail that satisfies a fundamental functional need, an idea that solves a technical aspect and becomes a distinctive feature of the project. Breccia is a top with a round integrated washbasin in Flumood that can be made to measure. Its particularity lies in how the drain has been developed, a constant subject of investigation and research by antoniolupi. First company to eliminate the traditional waste fitting by proposing elegant and integrated solutions in the design of the element, today it has thought of Breccia, a cut that allows water to flow, a sign that starts from a hole and in the groove digs into the material a continuum that connects it to the perimeter of the sink.



TOP
TOPS

Per collezione / For collection

ORMA - ATELIER - BESPOKE - PIANA - LUNARIA

art.

H	P	L			
1,2	54	da / from 72	a / to 272,4	BC154 + BRECCIA	
	54	da / from 144	a / to 272,4	BC154 + n° 2 BRECCIA	

Per collezione / For collection

PANTA REI

art.

H	P	L			
1,2	54	da / from 72	a / to 216	BC254 + BRECCIA	
	54	da / from 144	a / to 216	BC254 + n° 2 BRECCIA	

Per collezione / For collection

PLANETA

art.

H	P	L			
1,2	54	da / from 72	a / to 216	BC354 + BRECCIA	
	54	da / from 144	a / to 216	BC354 + n° 2 BRECCIA	

Top con singolo o doppio lavabo integrato in Flumood spessore 12 mm finitura Satin, completo di raccordo per sifone.

N.B. solo per porta lavabi H 37,5 e H 50 cm. Nei porta lavabi H 37,5 è possibile inserire solo sifone art. MICRO.

Top with single or double integrated sink in Flumood Satin finish 12 mm thick, with open plug.
P.S. only for sink units cm 37,5 and 50 H. In sink units cm 37,5 H it is only possible to use siphon art. MICRO.

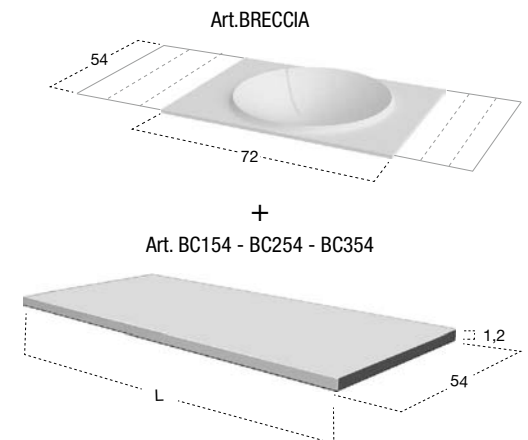

QUARZOMOOD

_2015

design
AL Studio

Insieme al Flumood, l'innovativo materiale composto per la maggior parte da idrossido di alluminio e resine sintetiche, frutto della ricerca antoniolupi, l'azienda propone dopo due anni di sperimentazioni il Quarzomood che oltre alla grandissima resistenza dovuta all'aggiunta di quarzo, consente nuove cromie. L'azienda ne ha sviluppate tre, denominate Serena, Terra e Seta che permettono ricercati accostamenti dei piani e dei lavabi integrati, sia con le nuove finiture dei mobili, sia con le versioni laccate e uniformi. Resistentissimo, facile da pulire, ripristinabile agevolmente in caso di graffi, bruciature o dall'usura dell'impiego quotidiano, Quarzomood mantiene inalterate le sue caratteristiche nel tempo e costituisce un altro passo verso quella ricerca della perfezione che caratterizza tutti i prodotti dell'azienda.

Together with Flumood, the innovative material composed mostly of aluminum hydroxide and synthetic resins a result of the antoniolupi research, the company proposes after two years of experimentation, Quarzomood. The great resistance, due to the addition of quartz, allows for new colors. The company has developed three different colors, Serena, Terra and Seta, which allow refined combinations of integrated surfaces and sinks, both with the new furniture finishes and with the lacquered and uniform versions. Extremely resistant, easy to clean, easily restored in case of scratches, burns or wear and tear of everyday use, Quarzomood maintains its characteristics unchanged over time and represents another step towards the search for perfection that characterizes all the company's products.



Top in Quarzomood Serena

Top in Quarzomood Serena

TOP

TOPS

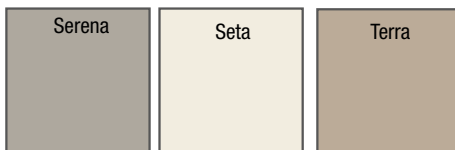

Per collezione / For collection

ORMA - ATELIER - BESPOKE - PIANA - LUNARIA

H	P	L	art.
1,2	40	da / from 72 a / to 218,4	QM140
	47		QM147
	54		QM154

Per collezione / For collection

PANTA REI

H	P	L	art.
1,2	40	da / from 72 a / to 216	QM240
	47		QM247
	54		QM254

Per collezione / For collection

PLANETA

H	P	L	art.
1,2	40	da / from 72 a / to 216	QM340
	47		QM347
	54		QM354

Top in Quarzomood, spessore 12 mm.

Top in Quarzomood, 12 mm thick.

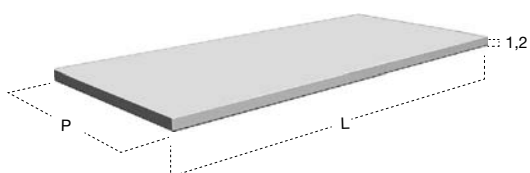



TOP
TOPS

Top in Quarzomood Seta
Top in Quarzomood Seta

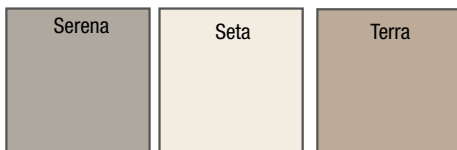

OPTIONAL
Troppopieno
Overflow

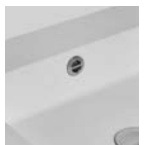

OPTIONAL
Pianetto copripiletta
Cover plate

Art. PIANETTOQ1

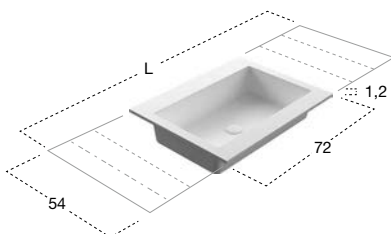
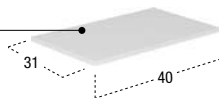

Per collezione / For collection

ORMA - ATELIER - BESPOKE - PIANA - LUNARIA

art.

H	P	L
1,2	54	da / from 72 a / to 218,4

NIDOQ172

Per collezione / For collection

PANTA REI

art.

H	P	L
1,2	54	da / from 72 a / to 216

NIDOQ272

Per collezione / For collection

PLANETA

art.

H	P	L
1,2	54	da / from 72 a / to 216

NIDOQ372

Top con lavabo integrato in Quarzomood completo di piletta con scarico libero e raccordo per sifone, disponibile in diversi colori come da nostro campionario
N.B. solo per porta lavabi H 37,5 e H 50 cm. Nei porta lavabi H 37,5 è possibile inserire solo sifone art. MICRO.

Top with integrated sink in Quarzomood complete with drain pipe fitting and plug, in various colours as per our samples

P.S. only for sink units cm 37,5 and 50 H. In sink units cm 37,5 H it is only possible to use siphon art. MICRO.



TOP
TOPS

Top in Quarzomood Terra
Top in Quarzomood Terra

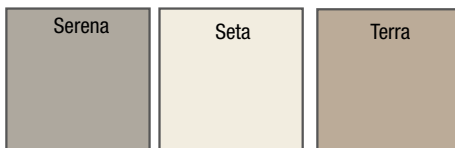

OPTIONAL
Troppieno
Overflow

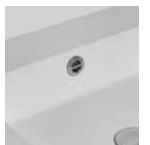

Per collezione / For collection

ORMA - ATELIER - BESPOKE - PIANA - LUNARIA

H	P	L
1,2	54	da / from 90 a / to 218,4

art.
NUVQ190

Per collezione / For collection

PANTA REI

H	P	L
1,2	54	da / from 90 a / to 216

art.
NUVQ290

Per collezione / For collection

PLANETA

H	P	L
1,2	54	da / from 90 a / to 216

art.
NUVQ390

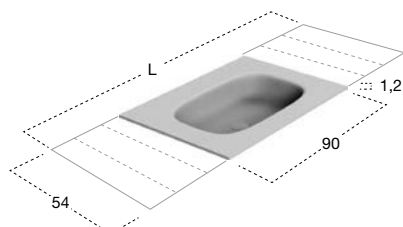

Top con lavabo integrato in Quarzomood completo di piletta con scarico libero e raccordo per sifone, disponibile in diversi colori come da nostro campionario
N.B. solo per porta lavabi H 37,5 e H 50 cm. Nei porta lavabi H 37,5 è possibile inserire solo sifone art. MICRO.

*Top with integrated sink in Quarzomood complete with drain pipe fitting and plug, in various colours as per our samples
P.S. only for sink units cm 37,5 and 50 H. In sink units cm 37,5 H it is only possible to use siphon art. MICRO.*



TOP
TOPS

Top in Quarzomood Terra
Top in Quarzomood Terra

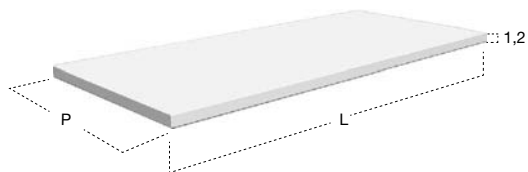

Per collezione / For collection

ORMA - ATELIER - BESPOKE - PIANA - LUNARIA

art.

H	P	L
1,2	40	da / from 27 a / to 299,4
	54	

CR140

CR154

Per collezione / For collection

PANTA REI

art.

H	P	L
1,2	40	da / from 36 a / to 216
	54	

CR240

CR254

Per collezione / For collection

PLANETA

art.

H	P	L
1,2	40	da / from 27 a / to 216
	54	

CR340

CR354

Top o alzatina in Corian spessore 12 mm.

Top or backsplash in Corian 12 mm thick.



TOP
TOPS

Per collezione / For collection

ORMA - ATELIER - BESPOKE - PIANA - LUNARIA

art.

H	P	L		art.
1,2	40	da / from 72	a / to 299,4	CR140 + MYSLOT472
	40	da / from 90	a / to 299,4	CR140 + MYSLOT490

Per collezione / For collection

PANTA REI

art.

H	P	L		art.
1,2	40	da / from 72	a / to 216	CR240 + MYSLOT472
	40	da / from 90	a / to 216	CR240 + MYSLOT490

Per collezione / For collection

PLANETA

art.

H	P	L		art.
1,2	40	da / from 72	a / to 216	CR340 + MYSLOT472
	40	da / from 90	a / to 216	CR340 + MYSLOT490

Top con lavabo integrato in Corian spessore 12 mm, con sistema di scarico predisposto per sifone.
N.B. solo per porta lavabi H 37,5 e H 50 cm. Nei porta lavabi H 37,5 è possibile inserire solo sifone art. MICRO.
Solo per rubinetteria a parete.

Top with integrated sink completely in Corian 12 mm thick, with drain prepared for siphon.
P.S. only for sink units cm 37,5 and 50 H. In sink units cm 37,5 H it is only possible to use siphon art. MICRO.
Only for wall mount tap.

Art. MYSLOT472 - MYSLOT490

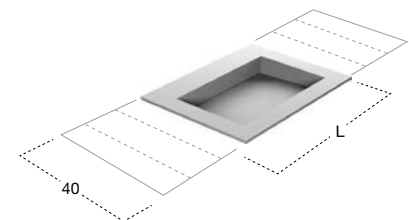

+

Art. CR140 - CR240 - CR340

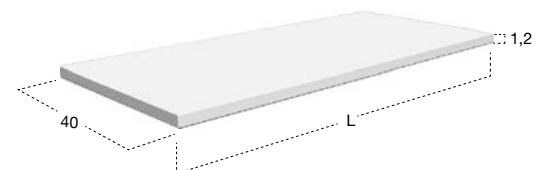



Art. MYSLOT72 - MYSLOT90

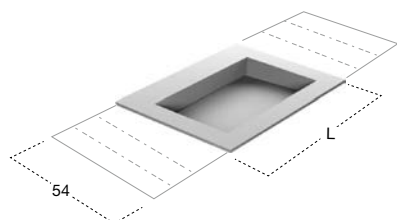

+

Art. CR154 - CR254 - CR354

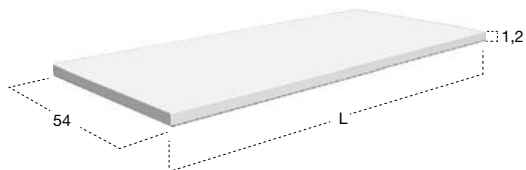

Per collezione / For collection

ORMA - ATELIER - BESPOKE - PIANA - LUNARIA

art.

H	P	L		
1,2	54	da / from 72	a / to 299,4	CR154 + MYSLOT72
	54	da / from 90	a / to 299,4	CR154 + MYSLOT90

Per collezione / For collection

PANTA REI

art.

H	P	L		
1,2	54	da / from 72	a / to 216	CR254 + MYSLOT72
	54	da / from 90	a / to 216	CR254 + MYSLOT90

Per collezione / For collection

PLANETA

art.

H	P	L		
1,2	54	da / from 72	a / to 216	CR354 + MYSLOT72
	54	da / from 90	a / to 216	CR354 + MYSLOT90

Top con lavabo integrato in Corian spessore 12 mm, con sistema di scarico predisposto per sifone.
N.B. solo per porta lavabi H 37,5 e H 50 cm. Nei porta lavabi H 37,5 è possibile inserire solo sifone art. MICRO.

Top with integrated sink completely in Corian 12 mm thick, with drain prepared for siphon.
P.S. only for sink units cm 37,5 and 50 H. In sink units cm 37,5 H it is only possible to use siphon art. MICRO.



TOP
TOPS

Per collezione / For collection

ORMA - ATELIER - BESPOKE - PIANA - LUNARIA

H	P	L			art.
1,2	54	da / from 144	a / to 299,4		CR154 + n° 2 MYSL0T72
	54	da / from 180	a / to 299,4		CR154 + n° 2 MYSL0T90

Per collezione / For collection

PANTA REI

H	P	L			art.
1,2	54	da / from 144	a / to 216		CR254 + n° 2 MYSL0T72
	54	da / from 180	a / to 216		CR254 + n° 2 MYSL0T90

Per collezione / For collection

PLANETA

H	P	L			art.
1,2	54	da / from 144	a / to 216		CR354 + n° 2 MYSL0T72
	54	da / from 180	a / to 216		CR354 + n° 2 MYSL0T90

Top con doppio lavabo integrato in Corian spessore 12 mm, con sistema di scarico predisposto per sifone.
N.B. solo per porta lavabi H 37,5 e H 50 cm. Nei porta lavabi H 37,5 è possibile inserire solo sifone art. MICRO.

Top with double integrated sink completely in Corian 12 mm thick, with drain prepared for siphon.
P.S. only for sink units cm 37,5 and 50 H. In sink units cm 37,5 H it is only possible to use siphon art. MICRO.

Art. MYSL0T72 - MYSL0T90

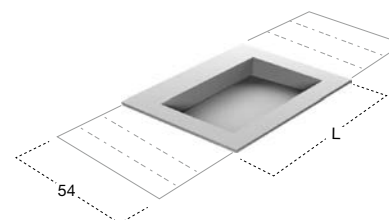

+

Art. CR154 - CR254 - CR354

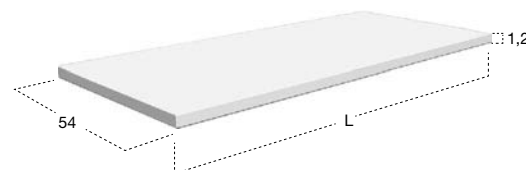





TOP
TOPS

Per collezione / For collection				
ORMA - ATELIER - BESPOKE - PIANA - LUNARIA				
H	P	L		art.
1,2	54	da / from 72	a / to 299,4	CR154 + SEGN072
	54	da / from 90	a / to 299,4	CR154 + SEGN090

Per collezione / For collection				
PANTA REI				
H	P	L		art.
1,2	54	da / from 72	a / to 216	CR254 + SEGN072
	54	da / from 90	a / to 216	CR254 + SEGN090

Per collezione / For collection				
PLANETA				
H	P	L		art.
1,2	54	da / from 72	a / to 216	CR354 + SEGN072
	54	da / from 90	a / to 216	CR354 + SEGN090

Top con lavabo integrato in Corian spessore 12 mm, completo di piletta con scarico libero e raccordo per sifone.
N.B. solo per porta lavabi H 37,5 e H 50 cm. Nei porta lavabi H 37,5 è possibile inserire solo sifone art. MICRO.

Top with integrated sink completely in Corian 12 mm thick, with drain pipe fitting and open plug.
P.S. only for sink units cm 37,5 and 50 H. In sink units cm 37,5 H it is only possible to use siphon art. MICRO.

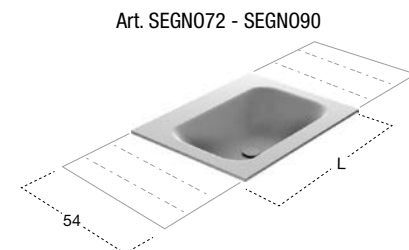

Art. SEGN072 - SEGN090

+

Art. CR154 - CR254 - CR354

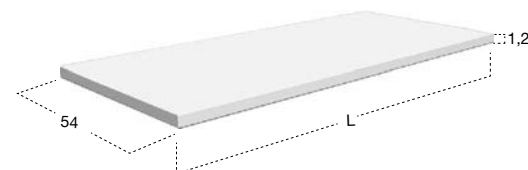



Art. SEGN072

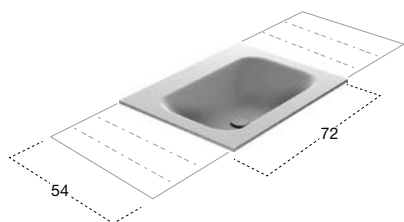

+

Art. CR154 - CR254 - CR354

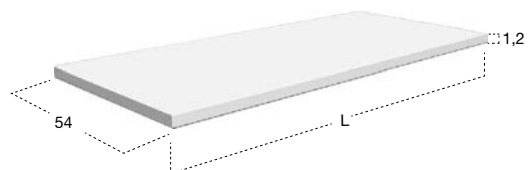

Per collezione / For collection

ORMA - ATELIER - BESPOKE - PIANA - LUNARIA

art.

H	P	L
1,2	54	da / from 144 a / to 299,4

CR154 + n° 2 SEGN072

Per collezione / For collection

PANTA REI

art.

H	P	L
1,2	54	da / from 144 a / to 216

CR254 + n° 2 SEGN072

Per collezione / For collection

PLANETA

art.

H	P	L
1,2	54	da / from 144 a / to 216

CR354 + n° 2 SEGN072

Top con doppio lavabo integrato in Corian spessore 12 mm, completo di piletta con scarico libero e raccordo per sifone.

N.B. solo per porta lavabi H 37,5 e H 50 cm. Nei porta lavabi H 37,5 è possibile inserire solo sifone art. MICRO.

Top with double integrated sink completely in Corian 12 mm thick, with drain pipe fitting and open plug. P.S. only for sink units cm 37,5 and 50 H. In sink units cm 37,5 H it is only possible to use siphon art. MICRO.



TOP
TOPS

Per collezione / For collection				
ORMA - ATELIER - BESPOKE - PIANA - LUNARIA				
H	P	L	art.	
1,2	54	da / from 180	a / to 299,4	CR154 + n° 2 SEGNO90

Per collezione / For collection				
PANTA REI				
H	P	L	art.	
1,2	54	da / from 180	a / to 216	CR254 + n° 2 SEGNO90

Per collezione / For collection				
PLANETA				
H	P	L	art.	
1,2	54	da / from 180	a / to 216	CR354 + n° 2 SEGNO90

Top con doppio lavabo integrato in Corian spessore 12 mm, completo di piletta con scarico libero e raccordo per sifone.

N.B. solo per porta lavabi H 37,5 e H 50 cm. Nei porta lavabi H 37,5 è possibile inserire solo sifone art. MICRO.

Top with double integrated sink completely in Corian 12 mm thick, with drain pipe fitting and open plug.

P.S. only for sink units cm 37,5 and 50 H. In sink units cm 37,5 H it is only possible to use siphon art. MICRO.

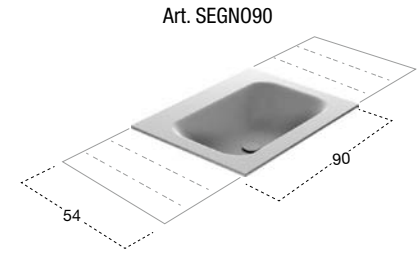

+

Art. CR154 - CR254 - CR354

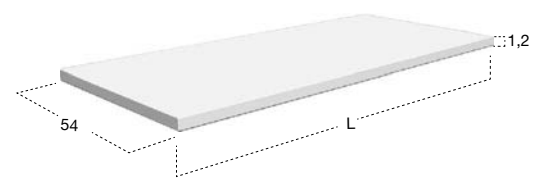



Art. ARC072 - ARC090

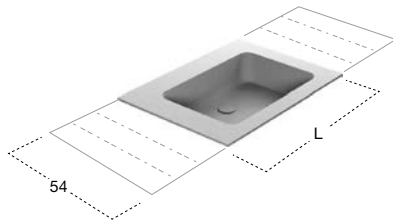

+

Art. CR154 - CR254 - CR354

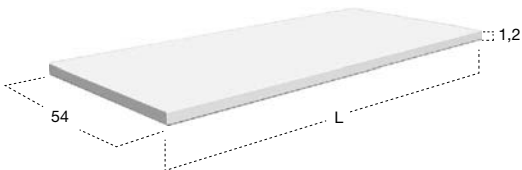

Per collezione / For collection

ORMA - ATELIER - BESPOKE - PIANA - LUNARIA

art.

H	P	L		
1,2	54	da / from 72	a / to 299,4	CR154 + ARC072
	54	da / from 90	a / to 299,4	CR154 + ARC090

Per collezione / For collection

PANTA REI

art.

H	P	L		
1,2	54	da / from 72	a / to 216	CR254 + ARC072
	54	da / from 90	a / to 216	CR254 + ARC090

Per collezione / For collection

PLANETA

art.

H	P	L		
1,2	54	da / from 72	a / to 216	CR354 + ARC072
	54	da / from 90	a / to 216	CR354 + ARC090

Top con lavabo integrato in Corian spessore 12 mm, completo di piletta con scarico libero e raccordo per sifone.
N.B. solo per porta lavabi H 37,5 e H 50 cm. Nei porta lavabi H 37,5 è possibile inserire solo sifone art. MICRO.

*Top with integrated sink completely in Corian 12 mm thick, with drain pipe fitting and open plug.
P.S. only for sink units cm 37,5 and 50 H. In sink units cm 37,5 H it is only possible to use siphon art. MICRO.*



TOP
TOPS

Per collezione / For collection

ORMA - ATELIER - BESPOKE - PIANA - LUNARIA

H	P	L	art.	
1,2	54	da / from 144	a / to 299,4	CR154 + n° 2 ARC072
	54	da / from 180	a / to 299,4	CR154 + n° 2 ARC090

Per collezione / For collection

PANTA REI

H	P	L	art.	
1,2	54	da / from 144	a / to 216	CR254 + n° 2 ARC072
	54	da / from 180	a / to 216	CR254 + n° 2 ARC090

Per collezione / For collection

PLANETA

H	P	L	art.	
1,2	54	da / from 144	a / to 216	CR354 + n° 2 ARC072
	54	da / from 180	a / to 216	CR354 + n° 2 ARC090

Top con doppio lavabo integrato in Corian spessore 12 mm, completo di piletta con scarico libero e raccordo per sifone.

N.B. solo per porta lavabi H 37,5 e H 50 cm. Nei porta lavabi H 37,5 è possibile inserire solo sifone art. MICRO.

Top with double integrated sink completely in Corian 12 mm thick, with drain pipe fitting and open plug.

P.S. only for sink units cm 37,5 and 50 H. In sink units cm 37,5 H it is only possible to use siphon art. MICRO.

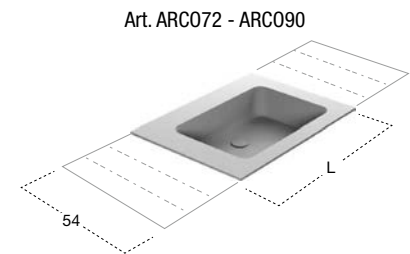

+

Art. CR154 - CR254 - CR354

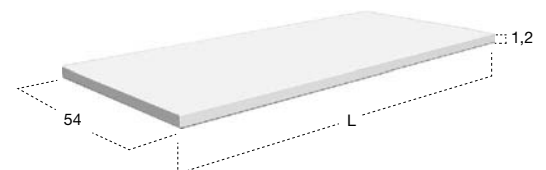

TOP VETRO
GLASS TOPS



TOP
TOPS

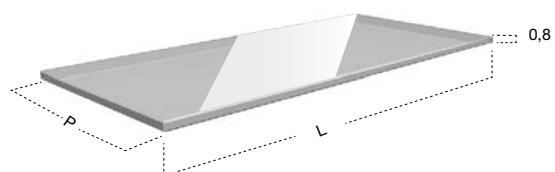

Per collezione / For collection

ATELIER - BESPOKE - PANTA REI - PLANETA - LUNARIA - PIANA - ORMA

art.

H	P	L	art.
0,8	40	da / from 27 a / to 218,4	IT1
	47		IT5
	54		IT2

Top in vetro lucido o acidato spessore 8 mm, verniciabile in tutti i colori del nostro campionario.

Lacquered or acid glass top 8 mm thick, can be lacquered in all colors of our collection.



TOP
TOPS

Per collezione / For collection

ATELIER - BESPOKE - PIANA - LUNARIA - ORMA

H	P	L	art.
1,2	40	da / from 27 a / to 218,4	919
	47		947
	54		910

Per collezione / For collection

PANTA REI

H	P	L	art.
1,2	40	da / from 36 a / to 216	PT1
	47		PT9
	54		PT2

Per collezione / For collection

PLANETA

H	P	L	art.
1,2	40	da / from 27 a / to 216	LT1
	47		LT3
	54		LT2

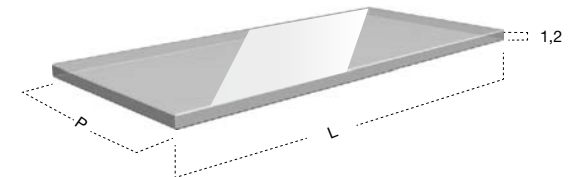

Top in vetro lucido o acidato spessore 12 mm, verniciabile in tutti i colori del nostro campionario.

Lacquered or acid glass top 12 mm thick, can be lacquered in all colors of our collection



H	P	L	Per collezione / For collection	
1,2	47	da / from 72	a / to 218,4	ATELIER - BESPOKE - PIANA - LUNARIA - ORMA art. 947 + SOAP4772

H	P	L	Per collezione / For collection	
1,2	47	da / from 72	a / to 216	PANTA REI art. PT9 + SOAP4772

H	P	L	Per collezione / For collection	
1,2	47	da / from 72	a / to 216	PLANETA art. LT3 + SOAP4772

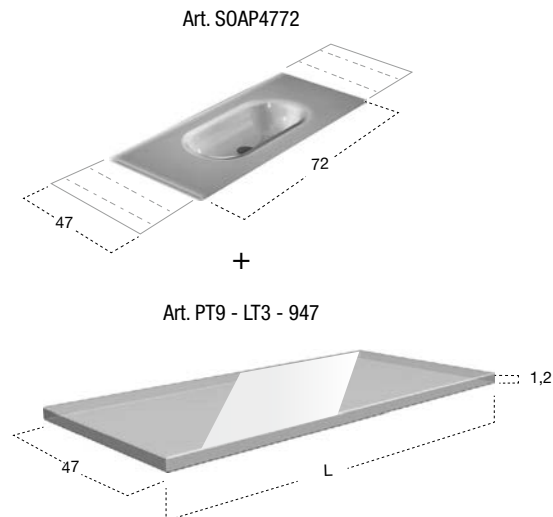

H	P	L	Per collezione / For collection	
1,2	54	da / from 72	a / to 218,4	ATELIER - BESPOKE - PIANA - LUNARIA - ORMA art. 910 + SOAP72

H	P	L	Per collezione / For collection	
1,2	54	da / from 72	a / to 216	PANTA REI art. PT2 + SOAP72

H	P	L	Per collezione / For collection	
1,2	54	da / from 72	a / to 216	PLANETA art. LT2 + SOAP72

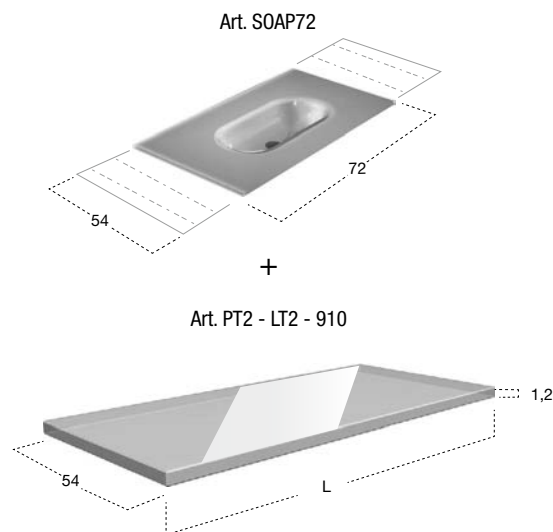

H	P	L	Per collezione / For collection	
1,2	54	da / from 90	a / to 218,4	ATELIER - BESPOKE - PIANA - LUNARIA - ORMA art. 910 + SOAP90

H	P	L	Per collezione / For collection	
1,2	54	da / from 90	a / to 216	PANTA REI art. PT2 + SOAP90

H	P	L	Per collezione / For collection	
1,2	54	da / from 90	a / to 216	PLANETA art. LT2 + SOAP90

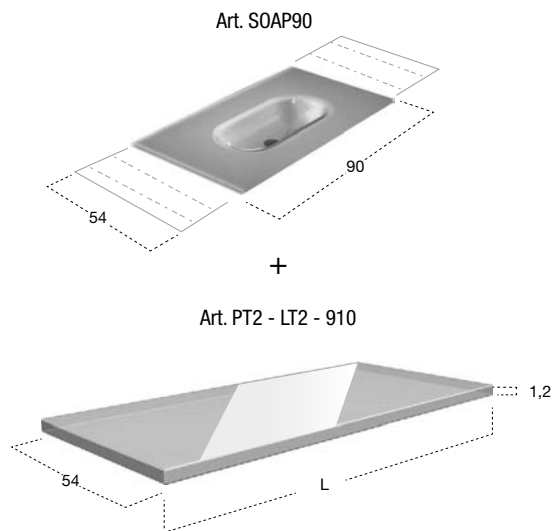

Top con lavabo integrato in vetro lucido o acidato spessore 12 mm, completo di piletta con scarico libero e raccordo per sifone. Verniciabile in tutti i colori del nostro campionario.

Top with integrated sink in laquered or acid glass 12 mm thick complete with drain pipe fitting and open plug. Can be lacquered in all colors of our collection.

TOP
TOPS



TOP SCATOLATI
SUSPENDED TOPS

TOP SCATOLATI
SUSPENDED TOPS

BANCO

_2003

design
AL Studio





TOP SCATOLATI
SUSPENDED TOPS

rovere thermo

I top scatolati sono realizzati con multistrato di betulla finlandese ad incollaggio fenolico con impiallacciatura in essenza di legno come da nostro campionario.

Boxy tops are made of Finnish Birch plywood with phenolic adhesives veneered in wood essence as per our samples.

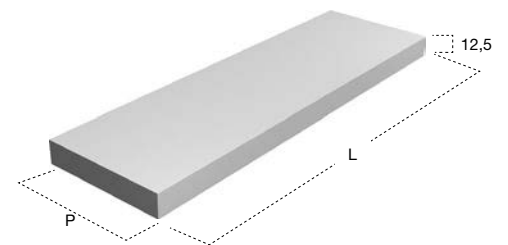

H	P	L	art.	
12,5	40	da / from 54	a / to 299,4	BANCO140
	47			BANCO147
	54			BANCO154

Top scatolare in legno spessore 125 mm.

Suspended wood top, 125 mm thick.





TOP SCATOLATI
SUSPENDED TOPS

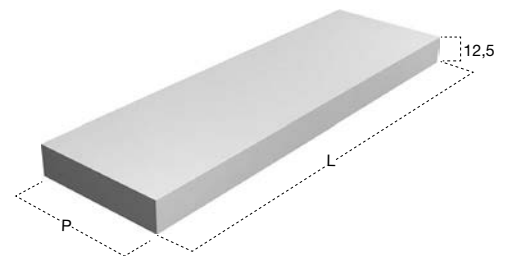

H	P	L	art.
12,5	40	da / from 72 a / to 272,4	BCS40
	47		BCS47
	54		BCS54

Top scatolare in Flumood in finitura Satin o Texture, spessore 125 mm.

Suspended Flumood top in Satin or Texture finish, 125 mm thick.



OPTIONAL
Troppieno
Overflow

Art. BASIC047 - BASIC054

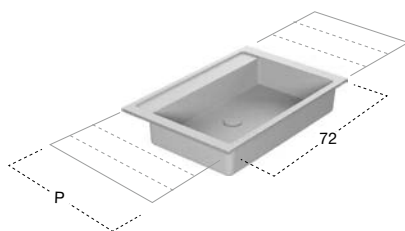

+

Art. BCS47 - BCS54

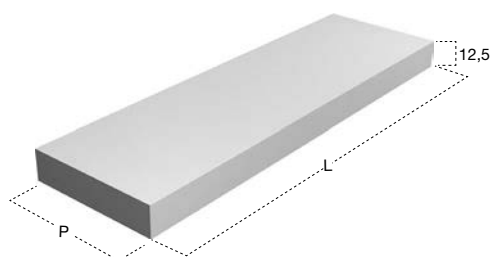

H	P	L	art.
12,5	47	da / from 72 a / to 272,4	BCS47 + BASIC047
	54		BCS54 + BASIC054

Top con lavabo integrato in Flumood finitura Satin, spessore 125 mm, completo di piletta con scarico libero e raccordo per sifone.

Top with integrated sink in Flumood Satin finish 125 mm thick, complete with drain pipe fitting and open plug.



TOP SCATOLATI
SUSPENDED TOPS

OPTIONAL
Troppieno
Overflow



Art. BASIC047 - BASIC054

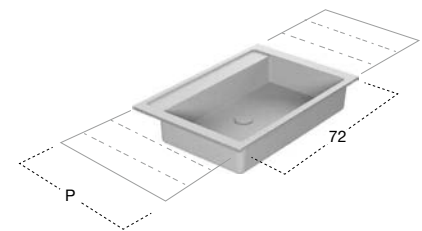

+

Art. BCS47 - BCS54

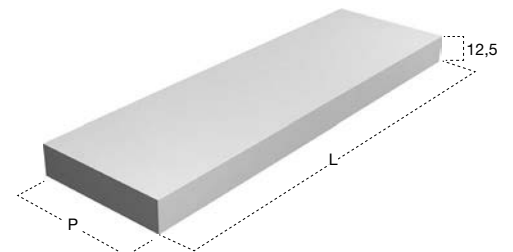

H	P	L	art.	
12,5	47	da / from 144	a / to 272,4	BCS47 + n° 2 BASIC047
	54			BCS54 + n° 2 BASIC054

Top con doppio lavabo integrato in Flumood finitura Satin spessore 125 mm, completo di piletta con scarico libero e raccordo per sifone.

Top with double integrated sink in Flumood Satin finish 125 mm thick, complete with drain pipe fitting and open plug.



OPTIONAL
Troppieno
Overflow

Art. NID054

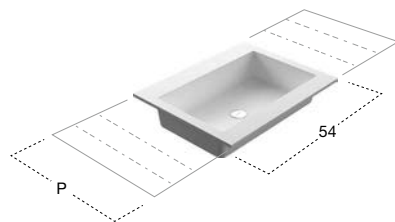

+

Art. BCS47 - BCS54

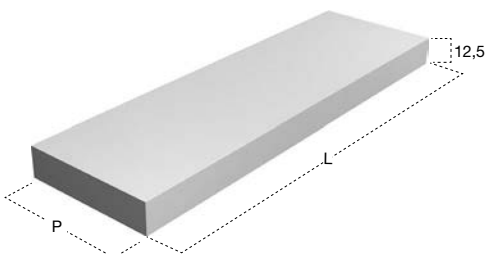

OPTIONAL
Pianetto copripiletta
Cover plate

Art. PIANETTO1

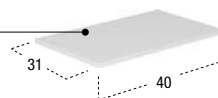

H	P	L	art.
12,5	47	da / from 54	a / to 272,4
			BCS47 + n° 2 NID054
			BCS54 + NID054

H	P	L	art.
12,5	47	da / from 108	a / to 272,4
			BCS47 + n° 2 NID054
			BCS54 + n° 2 NID054

Top con singolo o doppio lavabo integrato in Flumood finitura Satin spessore 125 mm, completo di piletta con scarico libero e raccordo per sifone.

Top with single or double integrated sink in Flumood Satin finish 125 mm thick, complete with drain pipe fitting and open plug.



TOP SCATOLATI
SUSPENDED TOPS

OPTIONAL
Troppopieno
Overflow



Art. PIANETTO2

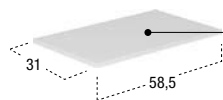

OPTIONAL
Pianetto copripiletta
Cover plate

Art. NID072

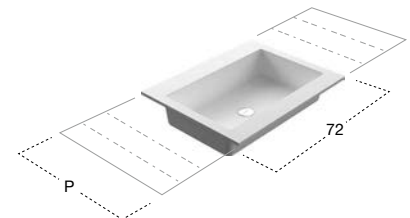

+

Art. BCS47 - BCS54

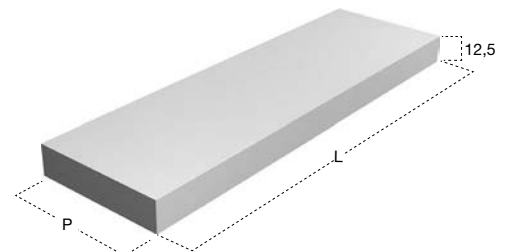

H	P	L	art.
12,5	47	da / from 72 a / to 272,4	BCS47 + NID072
	54		BCS54 + NID072

H	P	L	art.
12,5	47	da / from 144 a / to 272,4	BCS47 + n° 2 NID072
	54		BCS54 + n° 2 NID072

Top con singolo o doppio lavabo integrato in Flumood finitura Satin spessore 125 mm, completo di piletta con scarico libero e raccordo per sifone.

Top with single or double integrated sink in Flumood Satin finish 125 mm thick, complete with drain pipe fitting and open plug.





TOP SCATOLATI
SUSPENDED TOPS

OPTIONAL
Troppopieno
Overflow



H	P	L			art.
12,5	47	da / from 72	a / to 272,4		BCS47 + NUVOLA
	54				BCS54 + NUVOLA

H	P	L			art.
12,5	47	da / from 144	a / to 272,4		BCS47 + n° 2 NUVOLA
	54				BCS54 + n° 2 NUVOLA

Top con singolo o doppio lavabo integrato in Flumood finitura Satin spessore 125 mm, completo di piletta con scarico libero e raccordo per sifone.

Top with single or double integrated sink in Flumood Satin finish 125 mm thick, complete with drain pipe fitting and open plug.

Art. NUVOLA

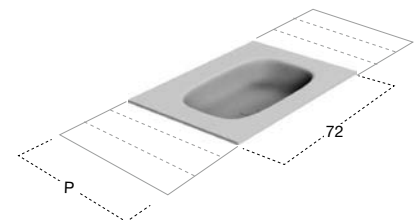

+

Art. BCS47 - BCS54

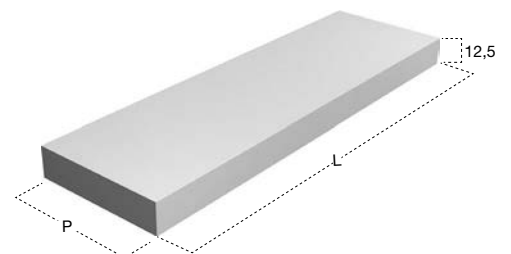





TOP SCATOLATI
SUSPENDED TOPS

H	P	L	art.
5	33	20	PIANETTO

Pianetto optional copripiletta in Flumood finitura Satin.

Optional Flumood drain cover in satin finish.

OPTIONAL
Troppieno
Overflow

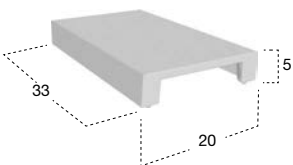
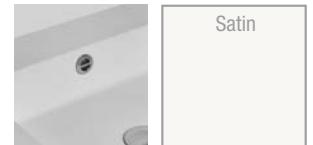

Art. PODIO

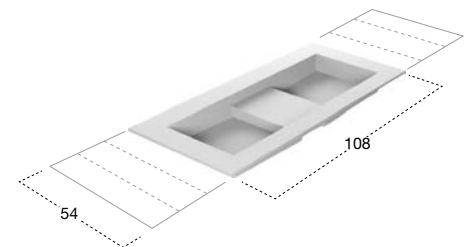

+

Art. BCS54

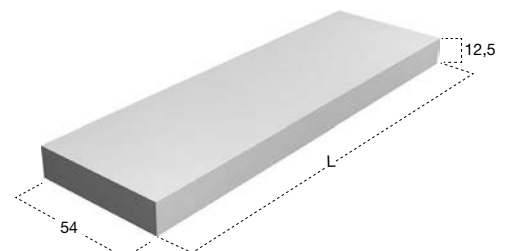

H	P	L	art.
12,5	54	da / from 108 a / to 272,4	BCS54 + PODIO

Top con lavabo integrato in Flumood in finitura Satin, spessore 125 mm, completo di piletta con scarico libero e raccordo per sifone.

Top with integrated sink in Flumood Satin finish, 125 mm thick complete with drain pipe fitting and open plug which may be wall mounted or used on furniture.



Art. OSM47 - OSM54

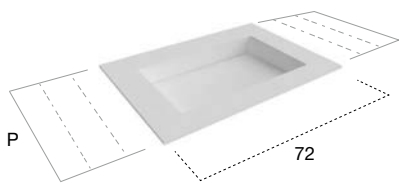

+

Art. BCS47 - BCS54

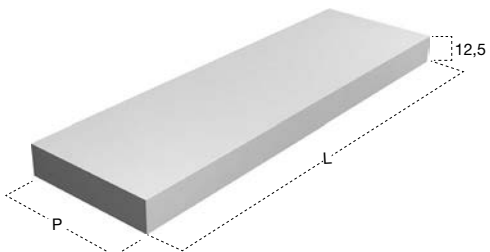

H	P	L	art.	
12,5	47	da / from 72	a / to 272,4	BCS47 + OSM47
	54			BCS54 + OSM54

Top con lavabo integrato in Flumood finitura Satin, spessore 125 mm, completo di piletta con scarico libero e raccordo per sifone.

Top with integrated sink in Flumood Satin, 125 mm thick complete with drain pipe fitting and open plug.



TOP SCATOLATI
SUSPENDED TOPS

Art. OSM47 - OSM54

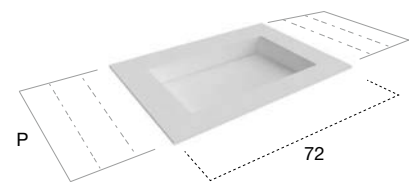

+

Art. BCS47 - BCS54

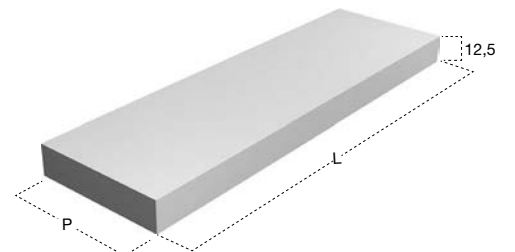

H	P	L	art.	
12,5	47	da / from 144	a / to 272,4	BCS47 + n° 2 OSM47
	54			BCS54 + n° 2 OSM54

Top con doppio lavabo integrato in Flumood finitura Satin, spessore 125 mm, completo di piletta con scarico libero e raccordo per sifone.

Top with double integrated sink in Flumood Satin, 125 mm thick complete with drain pipe fitting and open plug.



Art. MYSLOT472 - MYSLOT490 - MYSLOT72 - MYSLOT90

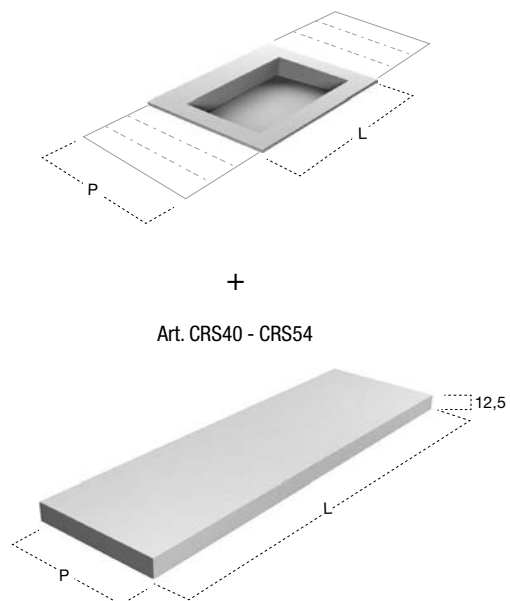

H	P	L			art.
12,5	40	da / from 72	a / to 299,4		CRS40 + MYSLOT472
	40	da / from 90	a / to 299,4		CRS40 + MYSLOT490
H	P	L			art.
12,5	54	da / from 72	a / to 299,4		CRS54 + MYSLOT72
	54	da / from 90	a / to 299,4		CRS54 + MYSLOT90

Top con lavabo integrato in Corian, spess. 125 mm con sistema di scarico predisposto per sifone.

Top with integrated sink completely in Corian 125 mm thick with drain prepared for siphon.



TOP SCATOLATI
SUSPENDED TOPS

Art. MYSLOT472 - MYSLOT490 - MYSLOT72 - MYSLOT90

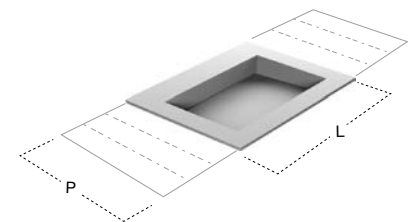

+

Art. CRS40 - CRS54

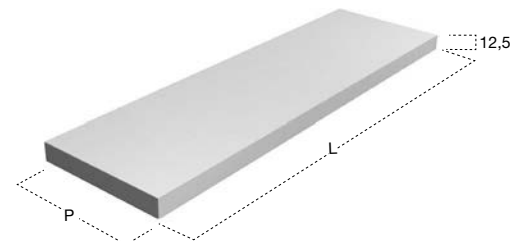

H	P	L			art.
12,5	40	da / from 144	a / to 299,4		CRS40 + n° 2 MYSLOT472
	40	da / from 180	a / to 299,4		CRS40 + n° 2 MYSLOT490
H	P	L			art.
12,5	54	da / from 144	a / to 299,4		CRS54 + n° 2 MYSLOT72
	54	da / from 180	a / to 299,4		CRS54 + n° 2 MYSLOT90

Top con doppio lavabo integrato in Corian, spess. 125 mm con sistema di scarico predisposto per sifone.

Top with double integrated sinks completely in Corian 125 mm thick with drain prepared for siphon.

SLOT

_2002

design
Nevio Tellatin



Ha cambiato il modo di concepire il lavabo, ha ridefinito l'archetipo di un suo componente meramente funzionale trasformandolo in strumento compositivo del progetto, ha sancito l'inizio di un nuovo percorso, quello del minimalismo assoluto. Pulito, essenziale, rigoroso, moderno. In una sola parola Slot. Il Corian come materiale d'elezione con il suo uniforme candore e la setosa superficie da toccare, il disegno come regola da seguire. Forme nette, linee squadrate, spigoli vivi e ampiezza dei bordi ma soprattutto totale assenza della piletta, del troppopieno, di tutto ciò che in qualche modo può offuscare la perfetta estetica dell'oggetto. Rimane una fessura, un taglio nella parte posteriore del bacino, un'apertura sottile che corre lungo tutto lo sviluppo del lavabo e accoglie l'acqua grazie all'impercettibile inclinazione del fondo, nascondendo alla vista il sifone integrato. Le parti tecniche sono invisibili, l'acqua defluisce lungo una scanalatura lineare, l'immagine del lavabo rimane pulita, assoluta, essenziale.

A different way of conceiving a sink redefining the archetype of its purely functional component of the project, transforming it into a compositional tool, marks the beginning of a new path, that of absolute minimalism.

Clean, essential, rigorous, modern. In one word Slot. Corian as a material of choice with its uniform whiteness and silky surface to touch, such as the design rule to follow. Net shapes, square lines, sharp edges and width of the borders but total absence of drain, overflow, of all that can somehow confuse the perfect aesthetics of the object. It remains a slit, a cut in the rear part of the basin, a thin opening that runs along the whole development of the basin and accommodates the water through the imperceptible inclination of the bottom, hiding the integrated siphon. The technical parts are invisible, water flows along a linear slot, the sink image remains clean, absolute, essential.



TOP SCATOLATI
SUSPENDED TOPS

Art. SLOT

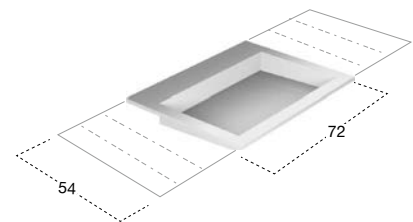

+

Art. CRS15

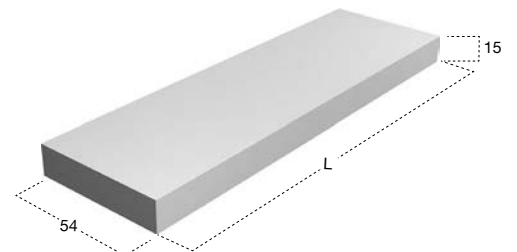

H	P	L	art.	
15	54	da / from 72	a / to 299,4	CRS15 + SLOT

Top con lavabo integrato in Corian spess. 150 mm, con sifone incorporato.

Top with integrated sink in Corian 150 mm thick with incorporated trap.





TOP SCATOLATI
SUSPENDED TOPS

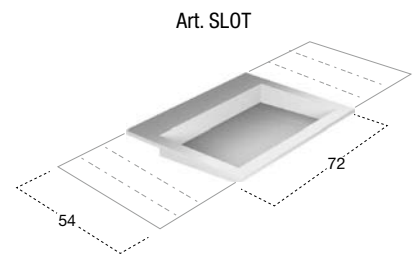

+

Art. CRS15

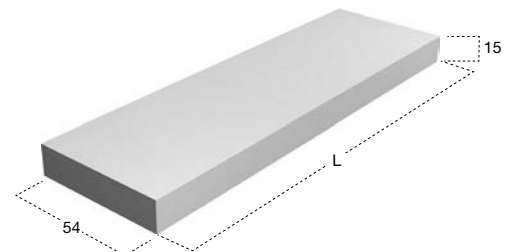

H	P	L	art.	
15	54	da / from 144	a / to 299,4	CRS15 + n° 2 SLOT

Top con doppio lavabo integrato in Corian, spess. 150 mm, con sifone incorporato.

Top with double integrated sinks completely in Corian 150 mm thick with incorporated trap.



Art. SEGN072 - SEGN090

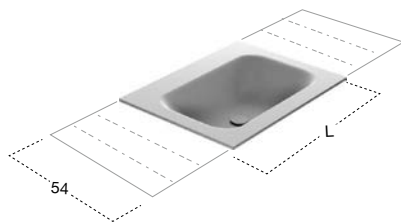

+

Art. CRS54

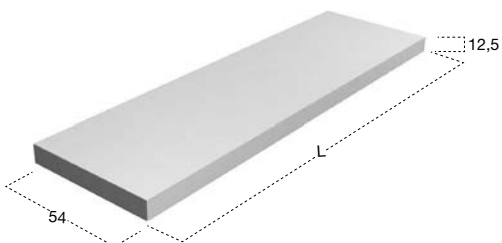

H	P	L	art.	
12,5	54	da / from 72	a / to 299,4	CRS54 + SEGN072
	54	da / from 90	a / to 299,4	CRS54 + SEGN090

Top con lavabo integrato sopra piano o da parete in Corian spessore 125 mm, completo di piletta con scarico libero e raccordo per sifone.

Top with integrated sink completely in Corian 125 mm thick complete with drain pipe fitting and open plug.



TOP SCATOLATI
SUSPENDED TOPS

Art. SEGN072 - SEGN090

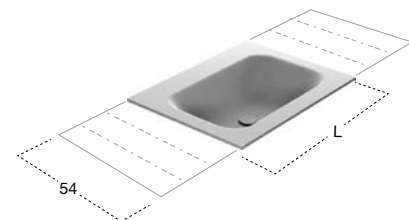

+

Art. CRS54

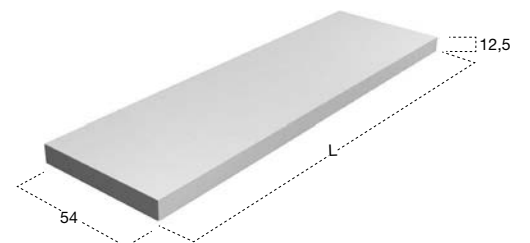

H	P	L	art.		
12,5	54	da / from 144	a / to 299,4	CRS54 + n° 2 SEGN072	
	54	da / from 180	a / to 299,4	CRS54 + n° 2 SEGN090	

Top con doppio lavabo integrato sopra piano o da parete in Corian spessore 125 mm, completo di piletta con scarico libero e raccordo per sifone.

Top with double integrated sink completely in Corian 125 mm thick complete with drain pipe fitting and open plug.



Art. ARC072 - ARC090

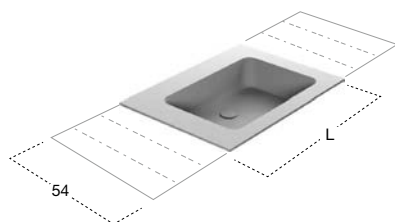

+
Art. CRS54

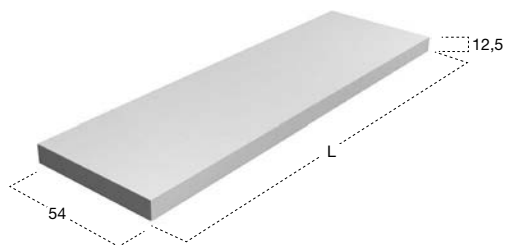

H	P	L	art.	
12,5	54	da / from 72	a / to 299,4	CRS54 + ARC072
	54	da / from 90	a / to 299,4	CRS54 + ARC090

Top con lavabo integrato sopra piano o da parete in Corian spessore 125 mm, completo di piletta con scarico libero e raccordo per sifone.

Top with integrated sink completely in Corian 125 mm thick complete with drain pipe fitting and open plug.



TOP SCATOLATI
SUSPENDED TOPS

Art. ARC072 - ARC090

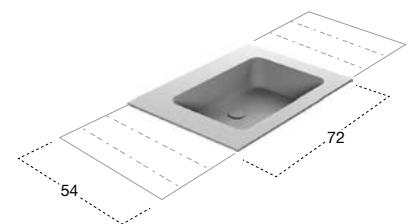

+

Art. CRS54

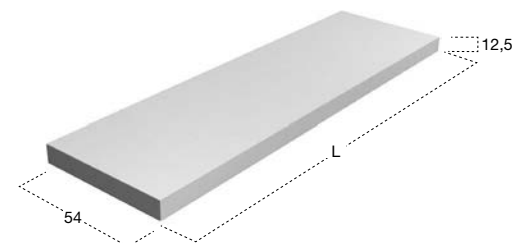

H	P	L	art.	
12,5	54	da / from 144	a / to 299,4	CRS54 + n° 2 ARC072
	54	da / from 180	a / to 299,4	CRS54 + n° 2 ARC090

Top con doppio lavabo integrato sopra piano o da parete in Corian spessore 125 mm, completo di piletta con scarico libero e raccordo per sifone.

Top with double integrated sink completely in Corian 125 mm thick complete with drain pipe fitting and open plug.



LAVABI D'ARCHITETTURA *ARCHITECTURE SINKS*

I lavabi incassati in Corian si integrano perfettamente nell'architettura degli
spazi affiorando dalle pareti

*The encased Corian sinks integrate perfectly into the architecture, emerging
from the walls.*

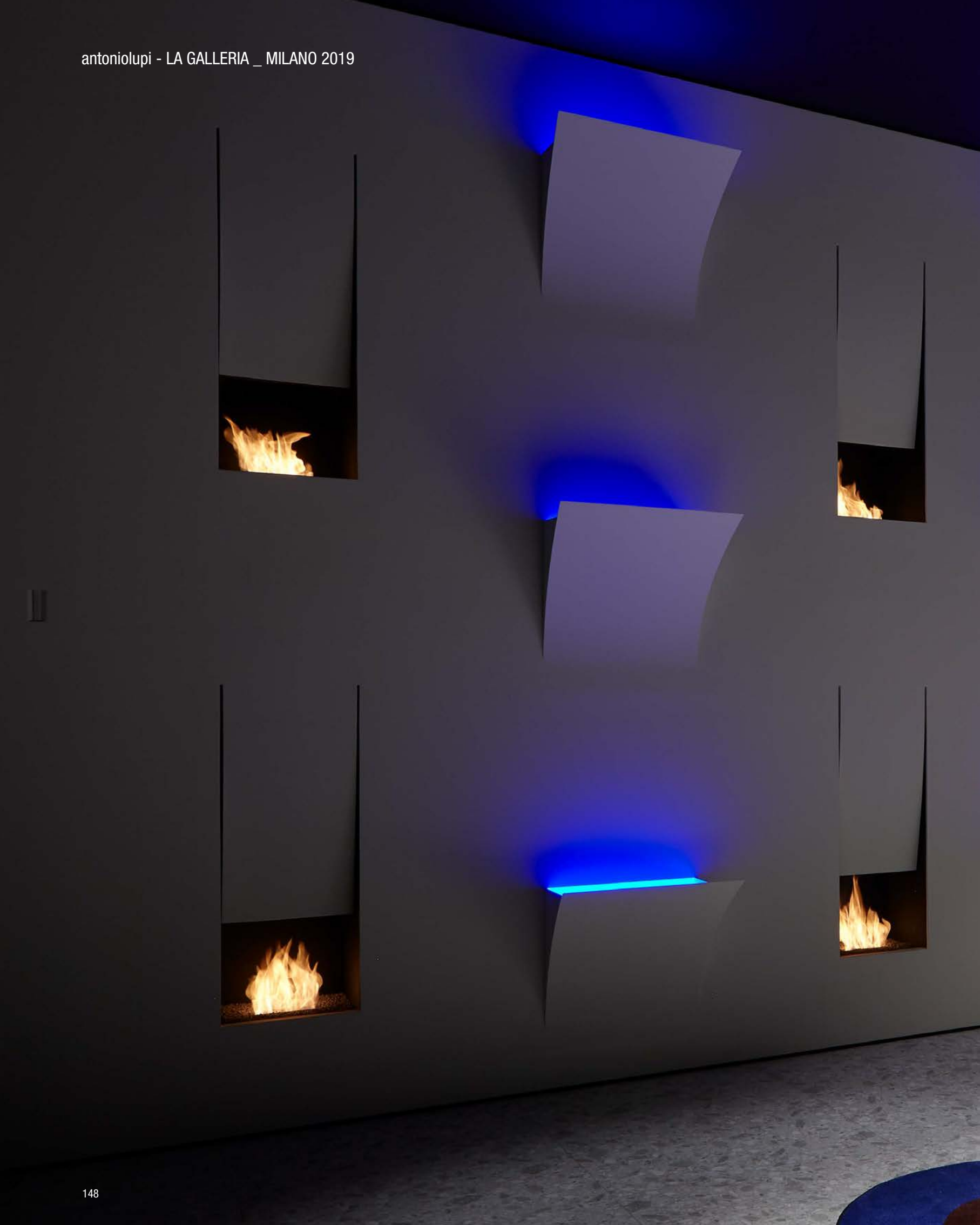



STRAPPO

_2011

design

Domenico De Palo

Modello e design registrato, brevetto depositato
Registered model and design, patent filed

L'essenza in un gesto
The essence in a gesture

Un lembo della parete che si strappa generando rumore, un foglio sottile che viene "tirato fuori dal muro" e rivela uno spazio nascosto, celato alla vista, nel quale è ospitato il lavabo. L'essenza in un gesto, quello dello strappo, del prendere una parte della parete e tirarla con forza rivelando con sorpresa ciò che vi è nascosto dietro. Strappo è il lavabo integrato che nasce dalla trasposizione di un'azione, che sembra voler uscire dal muro ma che allo stesso tempo si mimetizza nella parete, senza apparire in tutta la sua forma a una prima vista frontale ma svelando tutto se stesso solo dopo una visione laterale.

Strappo è realizzato interamente in Corian e può essere integrato perfettamente nella parete perché dopo essere stato installato può essere stuccato e rifinito con lo stesso materiale e colore di cui è composta la superficie muraria. Al contrario può essere valorizzato per contrasto definendo un campo di colore diverso da quello della parete. L'illuminazione led contribuisce ad accrescere la magia e a valorizzare la sensazione di fluido movimento, anche se generato da un'azione repentina, che è nel dna di questo scenografico lavabo.

A thin sheet that is "pulled out of the wall" and reveals a hidden space, hidden from sight, which houses the sink.

The essence in a gesture, that of a tear, taking a part of the wall and pulling it tight, surprisingly revealing what is hidden behind. Strappo is the integrated sink that comes from the implementation of an action, which seems to come out from the wall but at the same time blends within, without appearing in all its forms at a first front view but revealing all of itself only after viewing it from the side.

Strappo is made entirely in Corian and can perfectly be integrated in the wall because after installation can be stuccoed and finished with the same material and colour as the wall. It can also be enhanced if painted a different colour from the wall. The led lighting contributes to enhance the magic and the feeling of fluid movement even if generated by sudden action which is in the DNA of this sink.



LAVABI D'ARCHITETTURA
ARCHITECTURE SIMKS



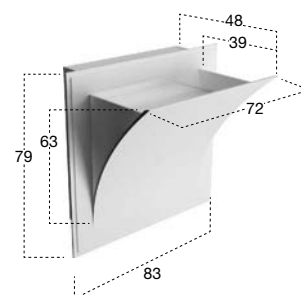

H	P	L	art.	art.
79	48	83	STRAPPO	STRAPPOL Con illuminazione a led / With led lighting

Lavabo da incasso a parete in Corian, con o senza illuminazione a led, completo di piletta ispezionabile, sifone e tubo flessibile.

Encased Corian sink with or without led lighting, complete with inspectable drain, trap and flexible hose.

STRAPPO







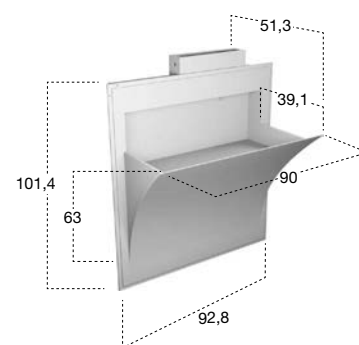

H	P	L	art.	art.
101,4	51,3	92,8	STRAPPOXL	STRAPPOXLL Con illuminazione a led / With led lighting

Lavabo da incasso a parete in Corian, con o senza illuminazione a led, completo di rubinetteria, piletta ispezionabile, sifone e tubo flessibile.

Encased Corian sink with or without led lighting, complete with tap, inspectable drain, trap and flexible hose.

SOFFIO

_2013

design

Domenico De Palo

Modello e design registrato, brevetto depositato

Registered model and design, patent filed

un soffio leggero che modella la materia dandole nuova forma
a slight wind that molds matter giving it a new shape

Un gesto delicato per descrivere l'essenza stessa del lavabo a muro, una perfetta fusione tra forme morbide e lineari, un soffio leggero che modella la materia dandole nuova forma.

Nasce dalla sintesi tra Strappo e Silenzio, definendo al meglio la simbiosi di questi lavabi con la parete dalla quale vengono generati. Soffio viene originato da una leggera folata di vento che delicatamente trasforma la superficie. Senza la forza di Strappo, senza l'organicità di Silenzio ma riproponendo un'immagine più conosciuta, seppur inedita nella sua creazione e concezione. Soffio affianca i modelli Strappo e Silenzio nel filone di ricerca di antoniolupi legato a una perfetta fusione tra l'oggetto, lo spazio e gli elementi architettonici che lo definiscono. In particolare l'integrazione di lavabi, accessori e camini nella parete è espressione della volontà di nascondere l'intervento artificiale dell'uomo lasciando all'acqua e al fuoco il ruolo di veri protagonisti del rito che si rinnova.

A delicate gesture to describe the essence of the sink, a perfect fusion between soft and linear shapes a slight wind that molds matter giving it a new shape.

Born from the synthesis between Strappo and Silenzio defining the best symbiosis of these basins with the wall from which they are generated. Soffio is originated by a light gust of wind that delicately transforms the surface. Without the force of Strappo, without the organic shape of Silenzio but proposing a more known image. Soffio joins the models Strappo and Silenzio in the line of research of antoniolupi tied to a perfect fusion between the object, the space and the architectural elements that define it. In particular the integration of sinks, accessories and chimneys in the wall are an expression of the will to hide the artificial intervention of man leaving water and fire the role of true protagonist.





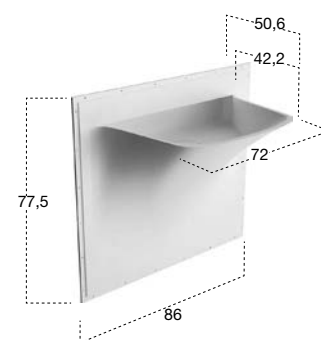

H	P	L	art.	art.
77,5	50,6	86	SOFFIO	SOFFIOL Con illuminazione a led / With led lighting

Lavabo da incasso a parete in Corian, con o senza illuminazione a led, completo di piletta ispezionabile, sifone e tubo flessibile.

Encased Corian sink with or without led lighting, complete with inspectable drain, trap and flexible hose.

SILENZIO

_2012

design

Domenico De Palo

Modello e design registrato, brevetto depositato

Registered model and design, patent filed

un taglio e una luce

a cut and a light

Un gesto scultoreo e delicato, un segno generatore, una morbida sinuosità che fuoriesce dalla parete; in sintesi un taglio e una luce, quali unici elementi della composizione

La funzionalità diventa oggetto inedito, esclusivo. Il ruolo del bacino, quello del contenere definisce l'aspetto finale del lavabo attraverso una forma organica che accoglie l'acqua che sgorga come una sorgente dalla parete. Silenzio è un lavabo integrato che diventa tutt'uno con la parete stessa, è un taglio di luce che sottolinea un andamento sinuoso, descrive un gesto creativo, da cui tutto ha origine.

Un lavabo nudo, realizzato interamente in Corian e poi integrato perfettamente nella parete nella quale si mimetizza al meglio quando vengono usati lo stesso rivestimento e gli stessi colori per completarlo. Il movimento sinuoso viene enfatizzato dalla perfezione della finitura e dall'assoluta continuità del rivestimento che lascia al colore il ruolo di protagonista e alla luce il compito di esaltarlo e di segnalare che qualcosa di magico sta accadendo oltre la superficie.

A sculptural and delicate gesture that comes out of the wall; in summary a cut and a light the essential elements of the composition.

Function becomes an unusual and exclusive object. The role of the basin defines the final aspect through an organic form that welcomes water that comes from the wall. Silenzio is an integrated sink that becomes one with the wall, it is a cut of light the underlines a sinuous course, it describes a creative gesture from which everything originates.

A bare sink made entirely in Corian and than seamlessly integrated in the wall which blends best when the same material and colours as the wall are used to complete it. The sinuous movement can be emphasized with the perfection of the finish and absolute continuity of the coating that leaves colour as the lead player and light the role to exalt it showing that something magical is happening.





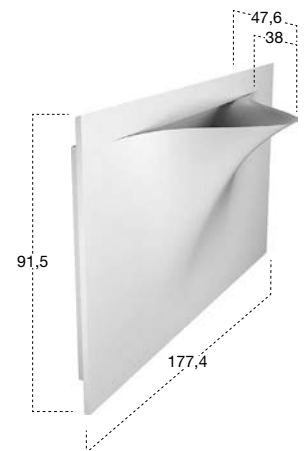

H	P	L	art.	art.
91,5	47,6	177,4	SILENZIO	SILENZIOL Con illuminazione a led / With led lighting

Lavabo da incasso a parete in Corian, con o senza illuminazione a led, completo di piletta ispezionabile, sifone e tubo flessibile.

Encased Corian sink with or without led lighting, complete with inspectable drain, trap and flexible hose.

CALICE

_2017

design

Domenico De Palo

Mario Ferrarini

Modello e design registrato, brevetto depositato
Registered model and design, patent filed

L'equilibrio dei volumi, le profondità di colonna e bacino,
il perfetto raccordo tra le parti.

*The balance of the volumes, the depths of the column
and basin, the perfect connection between the parts.*

Una forma appena accennata che nasce dal sapiente controllo della forza dirompente del segno, un volume leggero che morbidamente fuoriesce dalla parete per inoltrarsi sinuosamente nello spazio, un riferimento esplicito a un'immagine classica reinterpretata attraverso un materiale contemporaneo grazie al quale conferire assoluta continuità alla superficie.

Il racconto del magico incontro tra spazio e materia si arricchisce di un nuovo episodio. Dopo Strappo, Silenzio e Soffio prosegue la ricerca di antoniolupi sul tema dell'integrazione tra lavabo e parete, sulla possibilità di dare continuità alla superficie verticale per descrivere un bacino che accoglie l'acqua in uno spazio fluido e avvolgente. Con Calice, la tradizionale scansione del lavabo a colonna viene sviluppata con eleganza e pulizia formale per una collezione in grado ancora una volta di emozionare.

L'equilibrio dei volumi, le profondità di colonna e bacino, il perfetto raccordo tra le parti. Un progetto di armonia e dialogo fra gli elementi, un insieme di raccordi assoluti e curve calibrate, un confronto tra naturale e artificiale, tra organicità e disegno architettonico che danno vita a un oggetto prezioso, un calice in Corian, che nobilita l'acqua che contiene.

A form that is born from the clever control of the disruptive force of the sign, a light volume that softly emerges from the wall to sinuously enter space, an explicit reference to a classical image reinterpreted through a contemporary material to give absolute continuity to the surface.

The story of the magical encounter between space and matter is enriched with a new episode. After Strappo, Silenzio and Soffio research continues for antoniolupi on the theme of integration between sink and wall, on the ability to give continuity to the vertical surface in order to describe a basin that welcomes water in a fluid and enveloping space. With Calice, the traditional sink is developed with elegance and formal cleansing for a collection that can once again thrill.

The balance of the volumes, the depths of the column and basin, the perfect connection between the parts. A project of harmony and dialogue between the elements, a set of absolute joints and calibrated curves, a comparison between natural and artificial, between organic and architectural design that give birth to a precious object, a glass in Corian, which enhances the water that it contains.



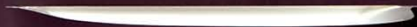



H	P	L	art.	art.
96,5	48	90	CALICE	CALICEL Con illuminazione a led / With led lighting

Lavabo da incasso a parete in Corian, con o senza illuminazione a led, completo di piletta ispezionabile, sifone e tubo flessibile.

Encased Corian sink with or without led lighting, complete with inspectable drain, trap and flexible hose.

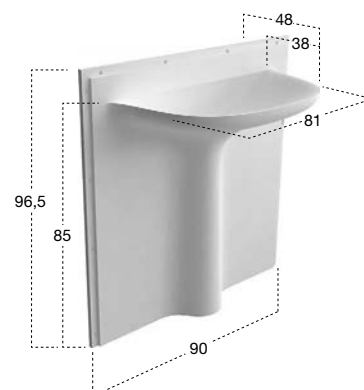

BATTIGIA

_2016

design

Michel

Boucquillon

Modello e design registrato, brevetto depositato

Registered model and design, patent filed

un fenomeno naturale, una piccola cascata,
il mare che si infrange sulla riva

*a natural phenomenon, a small cascade
or the sea breaking on the shore*

Battigia, è un nuovo lavabo in Corian, che continua e sviluppa la serie di lavabi "nascosti", che sono una peculiarità della produzione antoniolupi. In questo caso, l'unica cosa che fuoriesce dal muro, è una lastra in vetro inclinata (che può essere realizzata anche in marmo), mentre anche la rubinetteria scompare, celata nel vano della parete. Nella struttura interna, è integrata anche l'illuminazione a led con luce bianca e blu, che crea un effetto di grande suggestione. Quando il rubinetto è aperto e l'acqua scende, si ha l'impressione di un fenomeno naturale, una piccola cascata, il mare che si infrange sulla riva. Come gli altri lavabi incassati, anche Battigia può essere rivestito come si desidera, stuccato, intonacato, e verniciato.

Disponibile in cinque misure: 90, 108, 126, 144 e 180 cm, a richiesta può essere realizzato anche su misura.

Battigia is a new sink in Corian, that extends and develops the series of "hidden" sinks which are a peculiarity of the antoniolupi production. In this case, the only thing that protrudes from the wall is a sheet of inclined glass (that can also be made of marble) while the tap is hidden in the wall compartment. White and blue LED lighting is integrated in the structure creating an effect of great beauty. When the tap is open and the water falls one gets the impression of natural phenomenon, a small cascade or the sea breaking on the shore. As the other encased sinks Battigia can also be covered as one wishes, stuccoed, plastered and painted.

Available in five lengths; 90,108,126,144 and 180 cm upon request can be made to measure.

Dans toutes les choses de la nature il y a quelque chose de merveilleux

Aristotele

BATTIGIA, la merveille d'un lavabo inspiré par la nature.



LAVABI D'ARCHITETTURA
ARCHITECTURE SIMS





H	P	L	art.	art.
60,7	51,5	?	BATTIGIA	BATTIGIAL Con illuminazione a led / With led lighting

Lavabo da incasso a parete in Corian, con o senza illuminazione a led, completo di rubinetteria piletta ispezionabile, sifone e tubo flessibile, con lastra in cristallo extrachiaro o cristallo acidato. (L 90, 108, 126, 144, 180 cm)

Encased Corian sink with or without led lighting, complete with tap, inspectable drain, siphon and flexible hose. Available with extra-clear or acid glass surface. (L 90, 108, 126, 144, 180 cm)

H	P	L	art.	art.
60,7	51,5	?	BATTIGIAM	BATTIGIAML Con illuminazione a led / With led lighting

Lavabo da incasso a parete in Corian, con o senza illuminazione a led, completo di rubinetteria piletta ispezionabile, sifone e tubo flessibile, con lastra in marmo Carrara. (L 90, 108, 126, 144, 180 cm)

Encased Corian sink with or without led lighting, complete with tap, inspectable drain, siphon and flexible hose, with Carrara marble surface. (L 90, 108, 126, 144, 180 cm)

Art. BATTIGIA - BATTIGIAL

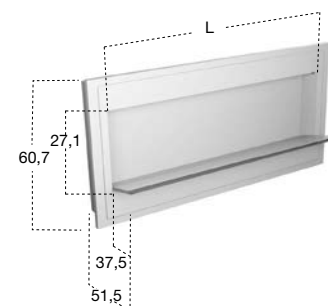

Art. BATTIGIAM - BATTIGIAML

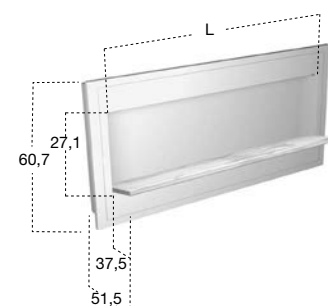

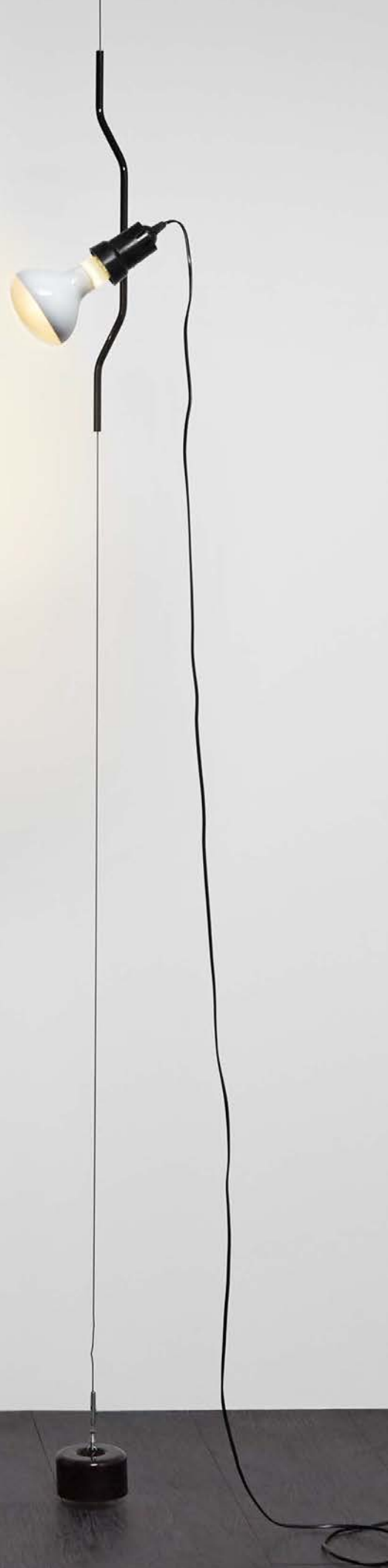

LAVABI FREESTANDING *FREESTANDING SINKS*

INTROVERSO

_2016

design

Paolo

Ulian

Modello e design registrato, brevetto depositato
Registered model and design, patent filed

La forma dentro la forma è stata l'idea che ha accompagnato sin dall'inizio il progetto Introverso di Paolo Ulian per antoniolupi. Un progetto nato osservando la lavorazione di sbizzo delle sculture di marmo, in cui la forma tridimensionale è delineata da una serie regolare di tagli gestiti da una macchina a controllo numerico. Si vengono in questo modo a formare sottili lamelle di marmo, i cui bordi esterni una volta spezzati, svelano la scultura grezza celata al suo interno. Stesso concetto e medesima lavorazione sono declinate nella realizzazione del lavabo Introverso: un blocco di marmo bianco Carrara, tornito e alleggerito da una serie di tagli che lasciano intravedere la sua anima interna, la forma dentro la forma.

Il blocco di marmo perde il suo aspetto monolitico e si trasforma in qualcosa di etereo, trasparente, che racchiude un'anima segreta. Anima che può rimanervi nascosta, lasciandosi intravedere dai sottili giochi di luce, o può essere lentamente svelata spezzando i bordi delle lamelle.

The shape within the form was the idea that accompanied from the very beginning the project by Paolo Ulian for antoniolupi. A project born by observing the first rough draft by machine of marble sculptures, in which the three-dimensional shape is outlined by a regular series of cuts managed by a numerical controlled machine. Thin strips of marble are formed, whose outer edges once broken, reveal the raw sculpture concealed inside.

The same concept and process are used in the realization of the Introverso sink: a white Carrara marble block, machined and lightened by a series of cuts that reveal its internal core, the shape inside the shape. The marble block loses its monolithic appearance and is transformed into something ethereal, transparent, enclosing a core secret. A soul that can remain hidden, leaving a glimpse of the subtle play of light, or it may be slowly unveiled by breaking the edges of the blades.





LAVABI FREESTANDING
FREESTANDING SINKS

INTROVERSO

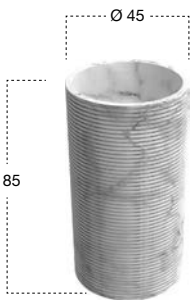

H	Ø	art.	
85	45	INTROVERSO3	Marmo Carrara

Lavabo da terra in pietra con scarico a pavimento, completo di piletta con scarico libero, sifone e tubo flessibile.
Peso lavabo: 223 kg ca.

*Freestanding stone sink with floor drainage complete with open plug, siphon and flexible hose.
Sink weight: 223 kg approx*

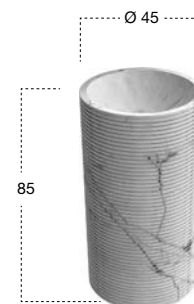

	H	Ø	art.
Marmo Carrara	85	45	INTROVERSO2

Lavabo da terra in pietra con scarico a pavimento, completo di piletta con scarico libero, sifone e tubo flessibile.

Peso lavabo: 223 kg ca.

*Freestanding stone sink with floor drainage complete with open plug, siphon and flexible hose.
Sink weight: 223 kg approx.*

INTROVERSO

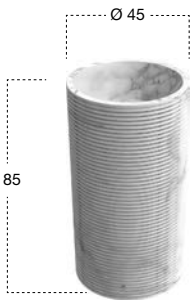

H	Ø	art.	
85	45	INTROVERSO1	Marmo Carrara

Lavabo da terra in pietra con scarico a pavimento, completo di piletta con scarico libero, sifone e tubo flessibile.
Peso lavabo: 223 kg ca.

*Freestanding stone sink with floor drainage complete with open plug, siphon and flexible hose.
Sink weight: 223 kg approx*



LAVABI FREESTANDING
FREESTANDING SINKS





LAVABI FREESTANDING
FREESTANDING SINKS

CONTROVERSO

_2017

design

Paolo

Ulian

Modello e design registrato, brevetto depositato
Registered model and design, patent filed

La tecnologia incontra la natura, l'evoluzione mantiene viva la memoria, il progetto permette di raccontare una storia. La forma viene generata per sottrazione come in una scultura, antica e contemporanea allo stesso tempo. Controverso nasce dal pensiero, dall'azione e trasforma il prodotto in esperienza. Un blocco di marmo viene solcato dalle fresature della macchina e poi interpretato dalla mano dell'uomo per dare vita a forme diverse.

Una proposta che nasce dal rispetto per la natura condiviso da Paolo Ulian e antoniolupi, un percorso sul marmo declinato in diverse collezioni che si inseriscono nel solco tracciato dai maestri che da sempre hanno interpretato questo materiale nobile.

Controverso è un monolite in marmo dalla forma stereometrica, squadrata, che viene lavorato per far esplodere tutta la sua forza intrinseca. Un gesto forte e delicato allo stesso tempo, un'interpretazione dell'atto creativo che incontra la produzione, un lavabo che trova posto in ambienti contemporanei ma anche in contesti diversi.

Technology meets nature, evolution keeps memory alive, the project allows you to tell a story. The form is generated by subtraction as in a sculpture, ancient and contemporary at the same time. Controverso springs from a thought, from action and transforms the product into an experience. A marble block is crossed by the milling machine and then interpreted by man to create different shapes.

A proposal that comes from respect for nature shared by Paolo Ulian and antoniolupi, a path with marble in different collections that fit into a path traced by masters that have always interpreted this noble material.

Controverso is a marble monolith of geometrical shape, squared, which is processed to detonate all its inherent strength. A strong and delicate gesture at the same time, an interpretation of the creative act that meets production, a sink that fits into contemporary environments but also in different contexts.





LAVABI FREESTANDING
FREESTANDING SINKS

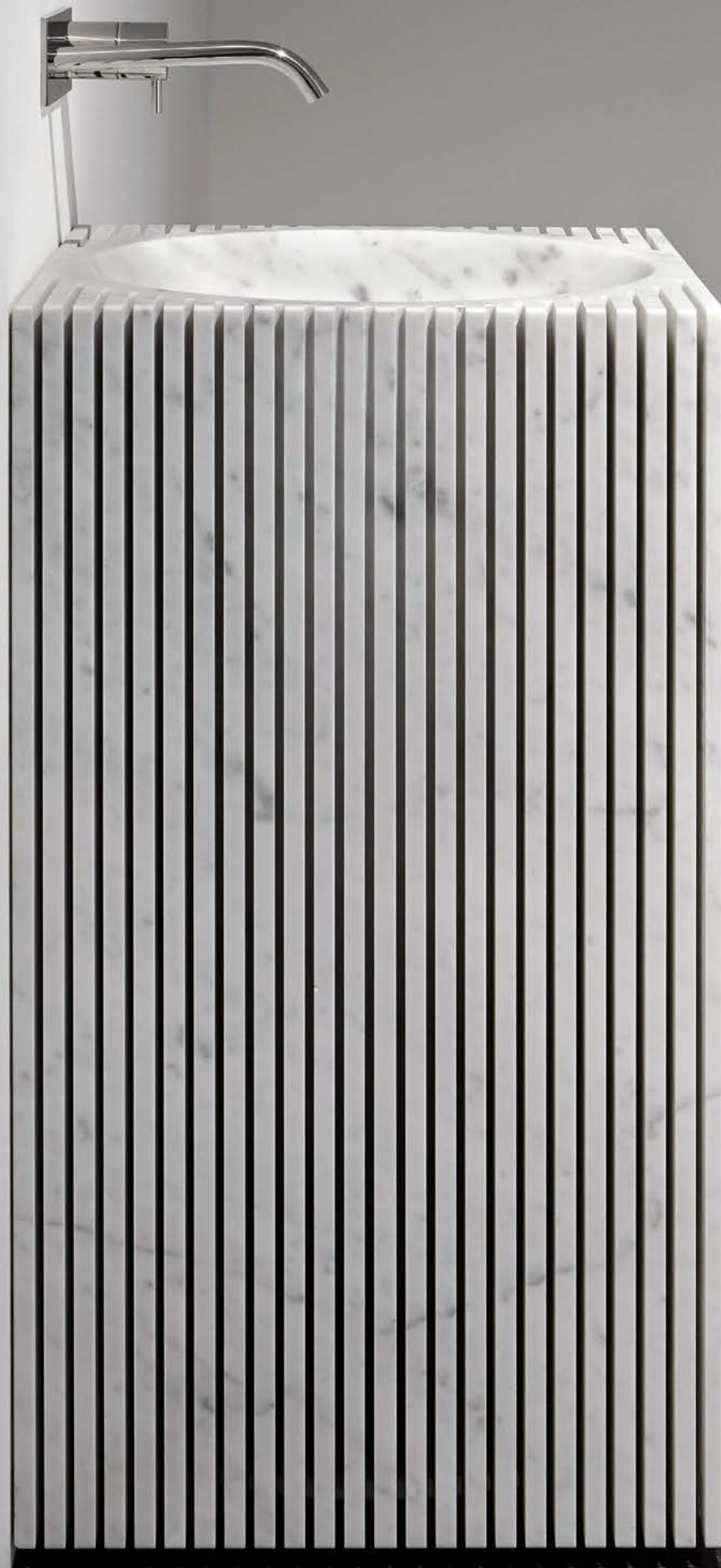



LAVABI FREESTANDING
FREESTANDING SINKS





LAVABI FREESTANDING
FREESTANDING SINKS

CONTROVERSO

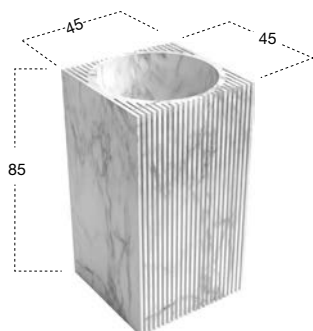

H	P	L	art.	
85	45	45	CONTROVERSO	Marmo Carrara

Lavabo da terra in pietra con scarico a pavimento, completo di piletta con scarico libero, sifone e tubo flessibile.
Peso lavabo: 361 kg ca.

*Freestanding stone sink with floor drainage complete with open plug, siphon and flexible hose.
Sink weight: 361 kg approx.*



LAVABI FREESTANDING
FREESTANDING SINKS

CONTROVERSO





LAVABI FREESTANDING
FREESTANDING SINKS

PIXEL

_2016

design

Paolo

Ulian

Modello e design registrato, brevetto depositato
Registered model and design, patent filed

Dalla materia più antica all'illusione di dare forma all'immateriale, dalla tradizione scultorea del "tutto tondo" alla suddivisione in piccole parti delle superfici per dar vita a un volume che è espressione della "sottrazione" di tanti piccoli punti. Il nome dice tutto: un pixel è un elemento puntiforme che compone un'immagine digitale, è insomma l'elemento più piccolo che la costituisce. La scomposizione in singoli pixel della superficie, una sorta di mosaico tridimensionale, conferisce un aspetto inedito al lavabo in marmo Pixel. Una forma che nasce per sottrazione, un'idea dell'uomo che prende vita grazie all'impiego della macchina e viene poi definita nel suo aspetto finale ancora attraverso le scelte dell'uomo.

Tradizione e tecnologia si incontrano in una forma unitaria scomposta, sezionata, solcata da un reticolo ortogonale, un volume cilindrico sul quale la macchina ha tracciato un segno netto e preciso secondo un progetto che lascia aperte infinite possibilità compositive, un lavabo freestanding che cambia continuamente volto perché eliminando i tasselli l'immaginazione prende forma, l'immagine si rivela, l'essenza viene alla luce. Luci e ombre, profondità e rilievi, accostamenti e lontananze, connessioni e isolamenti. Il gioco dei pixel che formano il lavabo è tutto orientato sulla consequenzialità, sulla prossimità, sul decoro che nasce dalla materia stessa. Un gesto, quello della sottrazione, che rivela la forma, che permette di personalizzare il volume, che amplifica la concezione tridimensionale del progetto. Pixel è sottrarre per comporre.

From the oldest material to the illusion of shaping the immaterial, from the sculptural tradition of the "well-rounded" shapes to the division in small parts of the surface to create a volume that is an expression of the "subtraction" of many small pieces. The name says it all: a pixel is a point-like element that makes up a digital image, in fact, it is the smallest element that constitutes it. The breakdown in individual pixels of the surface, a kind of three-dimensional mosaic, gives an unprecedented look at the marble sink Pixel. Shape is created by subtraction, man's idea that comes to life through the use of the machine that is then defined in the end again through man's choices. Tradition meets technology in a decomposed standardized form, sectioned, intersected by an orthogonal lattice, a cylindrical volume on which the machine has mapped out a clear and definite sign according to a project that leaves open endless possibilities of composition. A freestanding ever-changing sink due to the elimination of pieces imagination can take shape, the image is revealed, the essence comes to light. Lights and shadows, depth and reliefs, combinations and distances, connections and insulation. The pixel game that forms the basin is completely oriented on consequentiality, on proximity, on decorum that comes from the material itself. A gesture, that of subtraction, revealing the shape, which allows you to customize the volume, and which amplifies the three-dimensional design of the project. Pixel is subtraction to compose.





LAVABI FREESTANDING
FREESTANDING SINKS

PIXEL

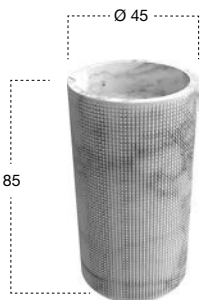

H	Ø	art.
85	45	PIXEL

Marmo Carrara

Lavabo da terra in pietra con scarico a pavimento, completo di piletta con scarico libero, sifone e tubo flessibile.
Peso lavabo: 177 kg ca.

*Freestanding stone sink with floor drainage complete with open plug, siphon and flexible hose.
Sink weight: 177 kg approx.*



LAVABI FREESTANDING
FREESTANDING SINKS

INTRECCIO

_2018

design
Paolo
Ulian



Un cesto di vimini, un fiore dalla corolla ad anelli, una stella filante che grazie a un soffio leggero rivela una magia inaspettata. Il lavoro dell'uomo incontra la natura per dar vita a Intreccio, il lavabo freestanding interamente realizzato in marmo, che gioca sul rapporto tra leggerezza del segno e la solidità del materiale utilizzato, sull'equilibrio tra un artificio sofisticato e una forma apparentemente naturale. Intreccio rappresenta la naturale evoluzione del percorso intrapreso più di un anno fa da antoniolupi e Paolo Ulian per indagare il rapporto tra un materiale antico e nuove tecniche di lavorazione. Iconico come i precedenti lavabi della collezione, dinamico, per la particolare geometria dei layer concentrici che vengono sfalsati quando vengono sovrapposti procedendo verso l'alto così da determinare un gioco di chiaroscuri e pieni e vuoti ottenuto unicamente dalla variazione della luce sulle forme concave o convesse. Intreccio nasce infatti da un blocco di marmo sul quale sono stati ottimizzati i tagli per ricavare tutte le parti necessarie a dar vita a un volume tridimensionale. Le tecnologie di lavorazione a controllo numerico hanno permesso di ottenere forme curvilinee e sottili, leggere quasi come se fossero di un altro materiale e non di marmo. Con Intreccio la ricerca di antoniolupi indaga un tema tanto caro all'azienda che è quello del risparmio delle risorse e dei materiali. Un unico blocco di marmo viene tagliato in 4 dai quali vengono ricavati 4 lavabi. Gli anelli che compongono Intreccio sono concentrici perché devono essere ricavati uno dentro l'altro dal blocco di marmo riducendo drasticamente gli scarti prodotti dal taglio. Senza dimenticare la leggerezza perché da sempre il peso è un fattore rilevante nella realizzazione di manufatti in marmo. Intreccio pesa "solo" 55 kg. Leggerezza, tecnologia che diventa espressione estetica e risparmio di materiale sintetizzano al meglio un progetto di grande impatto, un elemento attorno al quale dar vita a una composizione dell'ambiente bagno elegante e contemporanea.

A wicker basket, a flower with a ringed corolla, a streamlined star that, thanks to a light breath, reveals an unexpected magic. The work of man meets nature to give life to Intreccio, the freestanding washbasin entirely made of marble, which plays on the relationship between lightness and solidity of the material used, on the balance between a sophisticated piece and an apparently natural form. Intreccio represents the natural evolution of the path undertaken more than a year ago by antoniolupi and Paolo Ulian, to investigate the relationship between an ancient material and new processing techniques. Iconic like the previous washbasins of the collection, dynamic, for the particular geometry of the concentric layers that are staggered when they are overlapped proceeding upwards, so as to determine a play of light and dark and full and empty obtained only by the variation of light on concave or convex shapes. In fact, Intreccio is born from a block of marble on which the cuts have been optimized to obtain all the parts necessary to create a three-dimensional volume. The numerical control machining technologies have allowed to obtain curvilinear and thin shapes, light, almost as if they were of another material and not of marble. With Intreccio, the research of antoniolupi further investigates a topic that is of saving resources and materials. A single block of marble is divided into 4 from which 4 washbasins are made. The rings that make up Intreccio are concentric because they have to be obtained one inside the other from the block of marble drastically reducing the waste produced by the cut. Without forgetting lightness because weight has always been a significant factor in the production of marble products. Intreccio weighs "only" 55 kg. Lightness, technology that becomes an aesthetic expression and material savings summarize at best a project of great impact, an element which gives life to a composition of the elegant and contemporary bathroom.

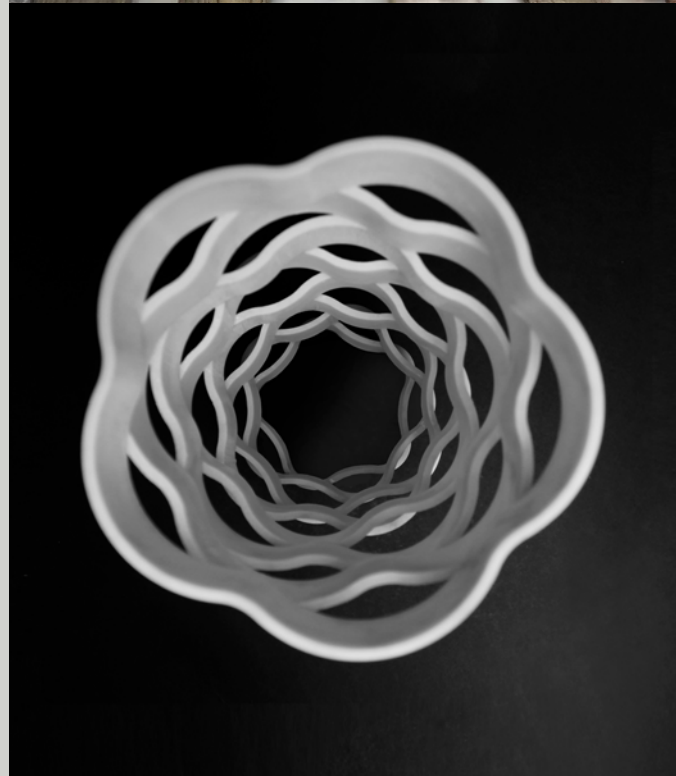



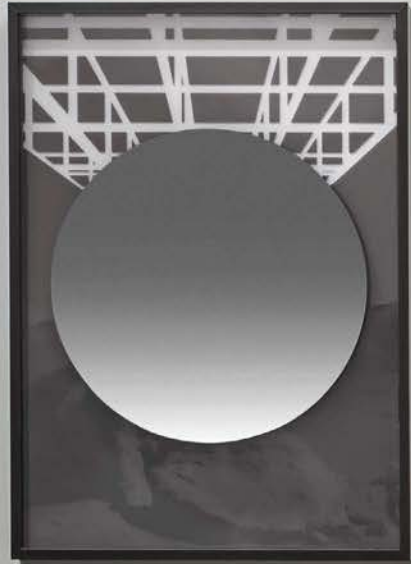

LAVABI FREESTANDING
FREESTANDING SINKS



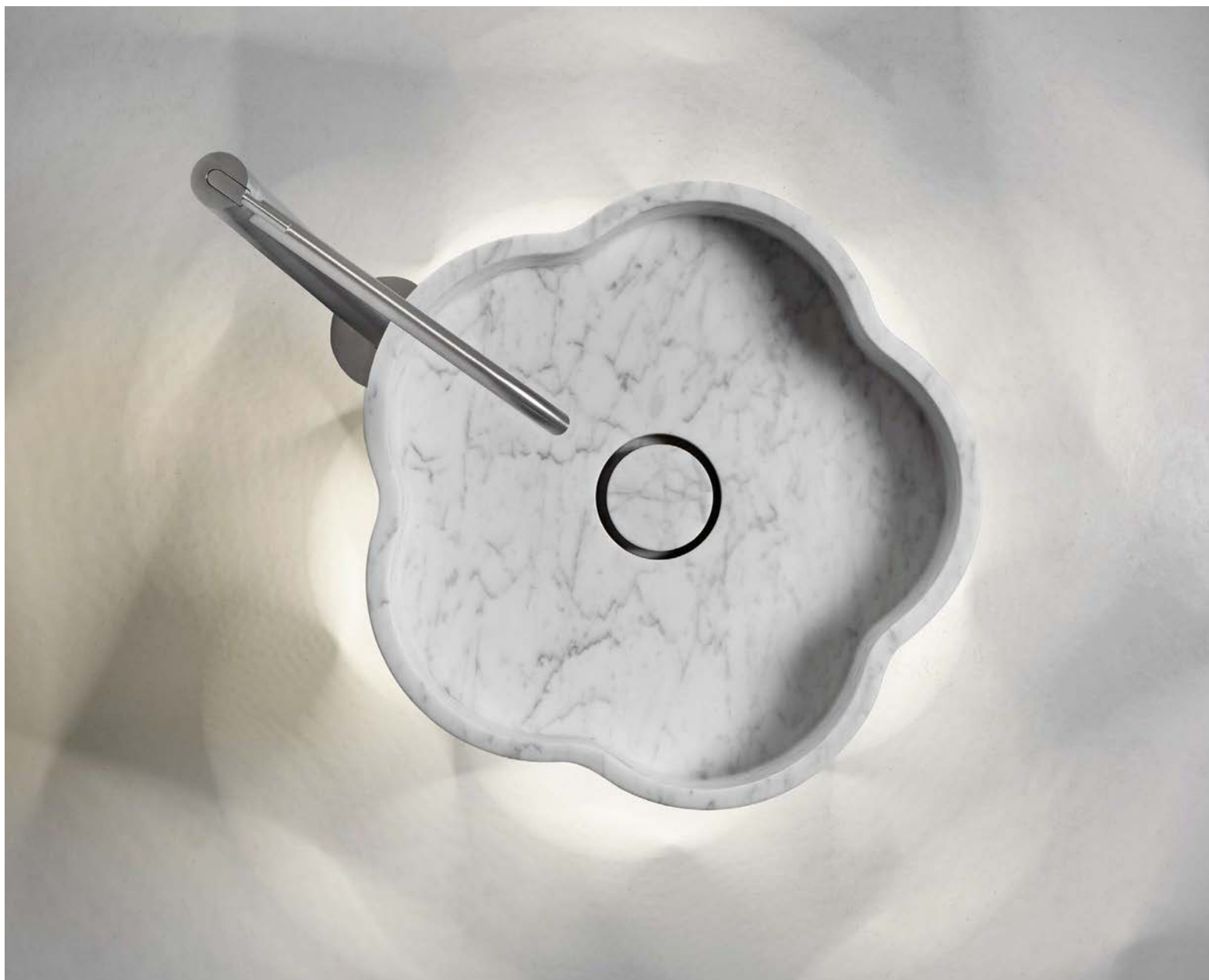

LAVABI FREESTANDING
FREESTANDING SINKS

	H	Ø	art.	art.
Marmo Carrara	85	47,5	INTRECCIO	INTRECCIOL Con illuminazione a led / With led lighting

Lavabo da terra in pietra con scarico a pavimento, con o senza illuminazione a led, completo di piletta con scarico libero, sifone e tubo rigido.

Peso lavabo: 55 kg ca.

Freestanding stone sink with floor drainage, with or without led lighting, complete with open plug, siphon and rigid tube.

Sink weight: 55 kg approx.

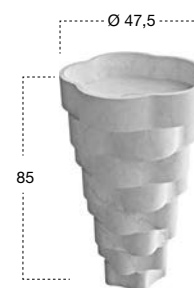





Composizione decorativa composta da 7 anelli in marmo di Carraraw
Decorative composition of 7 rings in Carrara marble.

LAVABI FREESTANDING
FREESTANDING SINKS

AGO

_2016

design
Mario
Ferrarini

Una forma pulita, fluida e iconica, quasi organica, naturale. Impreziosito dalla purezza della pietra, in due versioni bianca o nera, (bianco di Carrara o nero Marquinia) Ago è l'essenza del lavabo freestanding nella sua declinazione più "morbida", quasi sensuale. Elegante e minimale, ma sinuoso nella curva che raccorda il bacile alla colonna, Ago si colloca splendidamente in qualsiasi ambientazione, da quella più moderna, a quella più classica, improntando in maniera discreta tutto l'ambiente.

A clean, fluid and iconic shape, almost organic, natural. Embellished by the purity of stone, in two versions white or black (Carrara white or nero Marquinia) Ago is the essence of a freestanding sink in its more "soft", almost sensual declination. Elegant and minimal, but sinuous in the curve that connects the basin to the column, Ago fits beautifully into any setting, from the most modern, to the most classic, discreetly shaping the whole environment.



LAVABI FREESTANDING
FREESTANDING SINKS





Nero Marquinia

LAVABI FREESTANDING
FREESTANDING SINKS

	H	Ø	art.
Marmo Carrara / Nero Marquinia	85	50	AG0185

Lavabo da terra in pietra con scarico a pavimento, completo di piletta con scarico libero, sifone e tubo flessibile.

Peso lavabo: 57 kg ca.

*Freestanding stone sink with floor drainage complete with open plug, siphon and flexible hose.
Sink weight: 57 kg approx.*

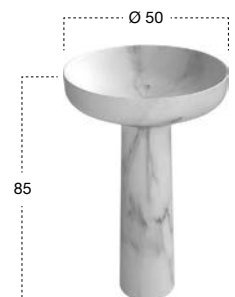

TENDER

_2004

design
Carlo
Colombo



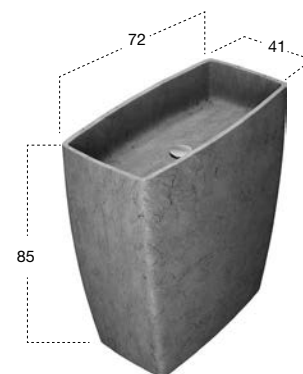

	H	P	L	art.
Pietra Stone Grey	85	41	72	TENDERSG

Lavabo da terra in pietra con scarico a pavimento, completo di piletta con scarico libero, sifone e tubo flessibile.

Peso lavabo: 300 kg ca.

*Freestanding stone sink with floor drainage complete with open plug, siphon and flexible hose.
Sink weight: 300 kg approx.*

RILIEVO

_2016

design
Carlo
Colombo

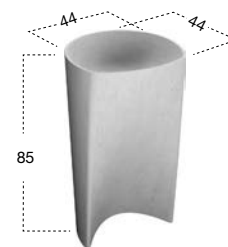

LAVABI FREESTANDING
FREESTANDING SINKS

	H	P	L	art.
Pietra Luna	85	44	44	RILIEVO

Lavabo da terra in pietra con scarico a pavimento, completo di piletta con scarico libero, sifone e tubo flessibile.

Peso lavabo: 170 kg ca.

*Freestanding stone sink with floor drainage complete with open plug, siphon and flexible hose.
Sink weight: 170 kg approx.*

BARREL

2003

design
Carlo
Colombo



Nero Marquina



Pietra Luna

Le forme bombate, l'immagine che rimanda all'archetipo del barile di legno, la figura massiccia, imponente, iconica nel suo sviluppo a tutto tondo e nella superficie perfettamente levigata. Occupa lo spazio imponendo fin da subito una gerarchia precisa a tutta la composizione, catturando il centro della scena. Nella sua versione originale accoglie alcolici, che preserva a lungo proteggendoli. Come lavabo invece è l'acqua a essere contenuta, non conservata, al suo interno. Barrel attua una trasposizione di funzione all'interno dello spazio domestico, mantenendo i caratteri di un'immagine amica con le sue forme bombate con la base ridotta a dare stabilità e a definire l'appoggio a terra del "barile". Disponibile in pietra o Cristalplant.

Rounded shapes, the image that points to the archetype of the wooden barrel, the massive figure, impressive, iconic in its all-round development and a perfectly smooth surface.

It occupies the space imposing immediately a precise hierarchy to the entire composition, capturing center stage. In its original version it held alcohol and preserved it for a long time protecting it. As washbasin instead the water is to be contained, not conserved, in its interior. Barrel implements a transposition function within the domestic space, maintaining the character of a pleasing picture rounded form with the reduced base to provide stability and support on the ground to define the "barrel". Available in stone or Cristalplant.

LAVABI FREESTANDING
FREESTANDING SINKS

	H	Ø	art.
Pietra Luna / Nero Marquina	85	65	BARREL

Lavabo da terra in pietra con scarico a pavimento, completo di piletta con scarico libero, sifone e tubo flessibile.

Peso lavabo: 320 kg ca.

*Freestanding stone sink with floor drainage complete with open plug, siphon and flexible hose.
Sink weight: 320 kg approx.*

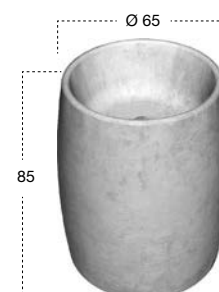

DIERESI

_2012

design
Carlo
Colombo





Scultoreo nella sua asimmetria pronunciata, dinamico grazie alla continuità tra base e bacino che si sviluppano secondo tracce diagonali, iconico nel suo “chiudersi” per poi “riaprirsi”. La base si stringe salendo verso l’alto, il bacino si allarga dalla dimensione minima in cui la incontra fino alla sommità. Il gioco di pieni e vuoti, di proporzioni inedite genera una sensazione di disequilibrio che è propria degli elementi naturali, cresciuti senza che l’uomo ne abbia in qualche modo definito regole precise e moduli da rispettare. Dieresi addolcisce i tratti diagonali con le linee morbide degli spigoli, con la continuità dei raccordi tra le linee convergenti, concentra le forze nel punto di contatto fra i due volumi principali e le fa esplodere allargandosi per accogliere l’acqua.

Sculptural in its pronounced asymmetry, dynamic thanks to the continuity between the base and the basin that develop along diagonal tracks, iconic when it “closes” and then “re-opens”. The base narrows going up to the top, the basin broadens. The solids and voids, of unprecedented proportions generates a feeling of imbalance which is characteristic of the natural elements. Dieresi sweetens the diagonal strokes with the soft lines of the edges, with the continuity of the connections between the converging lines, it focuses the forces at the contact point between the two main volumes and detonates, widening to accommodate the water.

LAVABI FREESTANDING
FREESTANDING SINKS

	H	P	L	art.
Marmo di Carrara	85	60	60	DIERESI

Lavabo da terra in pietra con scarico a pavimento, completo di piletta con scarico libero, sifone e tubo flessibile.

Peso lavabo: 190 kg ca.

*Freestanding stone sink with floor drainage complete with open plug, siphon and flexible hose.
Sink weight: 190 kg approx.*



PIPA

_2010

design
Carlo
Colombo





Marmo Carrara

Volumi importanti, perfetta continuità delle forme che rimandano a quelle di una pipa per la contrapposizione di un blocco importante orizzontale innestato su un fusto verticale. Un monolite dalla forma irregolare, un lavabo asimmetrico che sembra sfidare la forza di gravità con uno sbalzo molto pronunciato che si lancia nel vuoto. Un bacino capiente che completa un corpo identificato da un taglio diagonale che si raccorda perfettamente alla "mensola" orizzontale in una continuità dinamica che sembra lascia sfogare la forza sprigionata dal blocco di pietra. Una "L rovesciata" solida e preziosa, una figura in cui le linee convergono alternando superfici perfettamente piane e nette ad altre altrettanto curve e continue.

Important volumes, perfect continuity of forms that refer to those of a pipe for the juxtaposition of a horizontal block engaged on a vertical stem. A monolith with an irregular shape, an asymmetrical washbasin that seems to defy gravity with a very pronounced overhang that launches into space. A large basin that completes a body identified by a diagonal cut that is connected perfectly to the "horizontal shelf" in a dynamic continuity that seems to vent unleashed by the block of stone. An "inverted L" solid and valuable, a figure in which the lines converge alternating perfectly flat and net areas to other equally curved and continuous.

LAVABI FREESTANDING
FREESTANDING SINKS

	H	P	L	art.
Marmo di Carrara / Pietra Stone Grey / Nero Marquina	85	46	72	PIPA

Lavabo da terra in pietra con scarico a pavimento, completo di piletta con scarico libero, sifone e tubo flessibile.

Peso lavabo: 233 kg ca.

Freestanding stone sink with floor drainage complete with open plug, siphon and flexible hose. Sink weight: 233 kg approx.

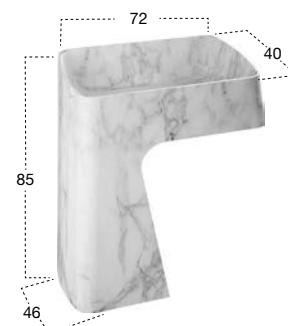





BLOKKO

BLOKKO11

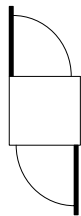
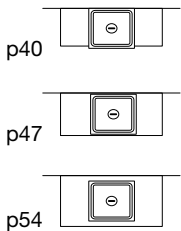

Art. BLOKKO

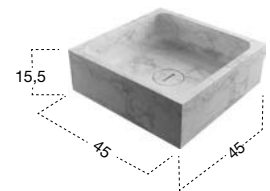

Art. BLOKKO11

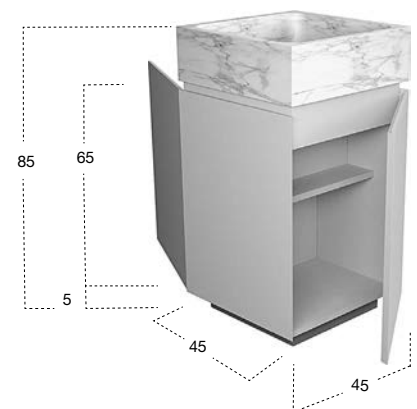

	H	P	L	art.
Marmo Carrara	15,5	45	45	BLOKKO

Lavabo quadro sopra piano in pietra, completo di piletta con scarico libero e raccordo per sifone.

Square top mount stone sink, complete with drain pipe fitting and open plug.

	H	P	L	art.
	85	45	45	BLOKKO11

Centro stanza con 2 ante, 1 posteriore e 1 anteriore dx o sx e 1 ripiano interno in legno, completo di zoccolo nero gofrato, e lavabo in Marmo di Carrara.

Freestanding cabinet with 2 doors, front and back right or left and one internal wooden shelf, complete with plinth lacquered embossed black and Carrara Marble sink.





BLOKKO2

BLOKKO10

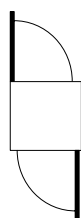
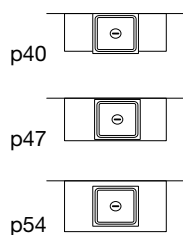

Art. BLOKKO

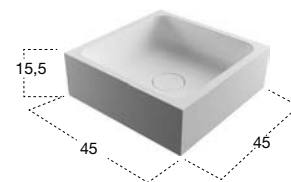

Art. BLOKKO11

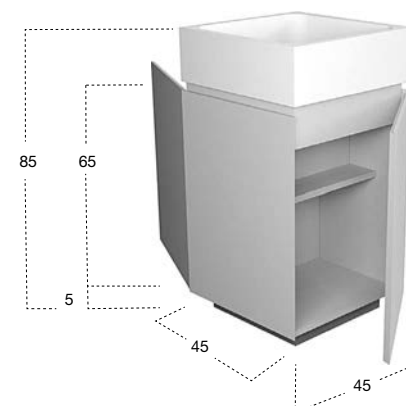

H	P	L	art.
15,5	45	45	BLOKKO2

Lavabo quadro sopraiano in Cristalplant, completo di piletta con scarico libero e raccordo per sifone.

Square Cristalplant top mount sink complete with drain pipe fitting and open plug.

H	P	L	art.
85	45	45	BLOKKO10

Centro stanza con 2 ante, 1 posteriore e 1 anteriore dx o sx e 1 ripiano interno in legno, completo di zoccolo nero goffrato, e lavabo in Cristalplant.

Freestanding cabinet with 2 doors, front and back right or left and one internal wooden shelf, complete with plinth lacquered embossed black and Cristalplant sink.

AGO

_2016

design
Mario
Ferrarini

La forma è fluida e iconica, la sottigliezza del bordo esalta la naturalità dell'immagine finale, la continuità delle linee evidenzia un dna organico che ammorbidisce le geometrie assolute.

Una nuova versione che esprime tutte le potenzialità del gesto, che valorizza al meglio il design elegante e armonico della collezione. Un'identità forte e allo stesso tempo naturale che trova nell'impiego del nuovo materiale, un prezioso alleato per la lettura complessiva del progetto. Ago85, realizzato in Flumood, è la sintesi armonica di volumi essenziali, è l'incontro virtuoso tra la geometria perfetta del bacino circolare dai bordi sottili e la base cilindrica che si restringe verso l'alto. Proprio la delicatezza con cui è risolto il raccordo tra base e bacino, è il tratto essenziale della collezione e in particolare di questo lavabo freestanding che diventa il fulcro di un ambiente bagno contemporaneo e trasversale.

Shape is fluid and iconic, the thinness of the edge enhances the naturalness of the final image, the continuity of the lines shows an organic DNA that softens the absolute geometries.

A new version that expresses the potential of the gesture which enhances the best elegant and harmonious design of the collection. A strong yet natural identity that when using the new material is a valuable ally for the overall interpretation of the project. Ago85, made from Flumood, is the harmonious synthesis of essential volumes, is the virtuous encounter between the perfect geometry of the circular basin with thin edges and the cylindrical base that narrows upwards. Just the delicacy with which it solves the connection between the base and the basin is the essential feature of the collection, and in particular of this freestanding washbasin that becomes the focus of a contemporary and transversal bathroom.



LAVABI FREESTANDING
FREESTANDING SINKS





Verniciabile esternamente in tutti i colori del nostro campionario
Can be externally lacquered in all colors of our collection

LAVABI FREESTANDING
 FREESTANDING SINKS

H	Ø	art.
85	50	AG085

Lavabo da terra in Flumood con scarico a pavimento, completo di piletta con scarico libero, sifone e tubo flessibile.

Freestanding Flumood sink with floor drainage complete with open plug, siphon and flexible hose.



SIMPLO

_2015

design
Mario
Ferrarini

Modello e design registrato, brevetto depositato
Registered model and design, patent filed

Un volume cilindrico perfetto, un lavabo freestanding che pur nelle dimensioni compatte occupa la scena con personalità e rigore. Il piano è integrato nel bacino ma fuori non ci sono orpelli o decori. Semplice come dice il nome, essenziale nell'esprimere una geometria perfetta, iconico, nel presentarsi come totem attorno al quale organizzare lo spazio. Simplo85 è realizzato in Flumood e si sviluppa da terra con un corpo cilindrico sulla cui sommità, il bacino del lavabo, viene in parte tagliato e occupato da un utilissimo piano d'appoggio. Disponibile nella versione total white o con la superficie esterna goffrata disponibile nelle tonalità della gamma antoniolupi o a richiesta su campione del cliente.

A perfect cylindrical volume, a freestanding sink that despite being compact occupies space with personality and rigor. The surface is integrated in the basin and the outer shape completely clean.

Simple as the name implies, essential in its geometrical shape, iconic and presents itself as a totem around which to organize the space. Simplo85 is made from Flumood, cylindrical in shape with the basin partially cut out and an integrated surface. Available in all white or two toned with the outer surface embossed lacquered available in all the antoniolupi colours or by request in another colour.





LAVABI FREESTANDING
FREESTANDING SINKS

SIMPLO





LAVABI FREESTANDING
FREESTANDING SINKS





OPTIONAL
Troppopieno
Overflow

Verniciabile esternamente in tutti i colori del nostro campionario
Can be externally lacquered in all colors of our collection

LAVABI FREESTANDING
FREESTANDING SINKS

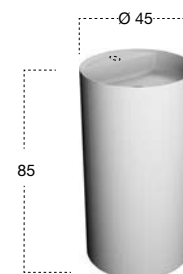

H	Ø	art.
85	45	SIMPL085

Lavabo da terra in Flumood con scarico a pavimento, completo di piletta con scarico libero sifone e tubo flessibile.

Freestanding Flumood sink with floor drainage complete with open plug siphon and flexible hose.

FUSTO

_2015

design
Nevio
Tellatin

Un totem assoluto, rigoroso, essenziale. Un lavabo dai bordi sottili, impreziosito da un elemento accessorio elegante e discreto che sottolinea la forma e ne aumenta la funzionalità

Come Simple ha nell'elemento accessorio un componente distintivo del progetto che assume un valore che va al di là della vera funzionalità. Fusto è il lavabo freestanding realizzato in Flumood dalla geometria rigorosa e dalle linee nette e precise. Una barra porta salviette, corre lungo due lati del lavabo sottolineandone la forma e definendo l'angolo. La sezione piatta trasmette continuità con il resto della composizione. Disponibile nella versione total white o con la superficie esterna goffrata disponibile nelle tonalità della gamma antoniolupi o a richiesta su campione del cliente.

An absolute totem, rigorous and essential. A sink with thin edges embellished with an elegant accessory discrete and subtle in form increasing its functionality.

As Simple this sink has a distinctive component of the project adding value and going beyond its functionality. Fusto is a freestanding sink made of Flumod with net precise lines. A towel bar runs along both sides of the basin underlining its shape and defining the corner. Available in either all white or embossed lacquered available in all the antoniolupi colours or by request in another colour.





LAVABI FREESTANDING
FREESTANDING SINKS

FUSTO





LAVABI FREESTANDING
FREESTANDING SINKS





Verniciabile esternamente in tutti i colori del nostro campionario
Can be externally lacquered in all colors of our collection

LAVABI FREESTANDING
 FREESTANDING SINKS

Art. FOLDVE

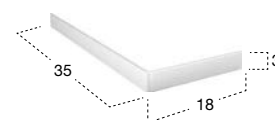

Art. FUSTO

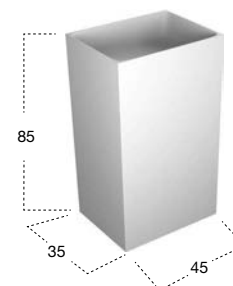

H	P	L	art.
85	35	45	FUSTO

Lavabo da terra in Flumood con scarico a pavimento, completo di piletta con scarico libero sifone e tubo flessibile.

Freestanding Flumood sink with floor drainage complete with open plug siphon and flexible hose.

H	P	L	art.
3	35	18	FOLDVE

Porta salviette in acciaio inox AISI 304 verniciato gofrato come da nostra cartella colori laccati.

Towel holder in stainless steel AISI 304 embossed lacquer finish as per our colour chart.

TUBA

_2008

design
Carlo
Colombo

Si apre come lo stelo di un fiore, stupisce per la forma organica e per le diverse posizioni che può assumere proponendo un'immagine sempre diversa, caratterizza lo spazio, senza essere troppo invadente. Si sviluppa in altezza allargandosi a partire dalla base tonda per aprirsi e accogliere con un gesto avvolgente lo scorrere dell'acqua. Tuba, realizzato in Cristalplant, rimanda a un'immagine estremamente naturale e si inserisce al meglio in atmosfere sofisticate dialogando con elementi dal forte impatto scenico. Nella versione freestanding propone una sezione diagonale che conferisce un aspetto inedito al bordo del bacino, mentre il suo aspetto scultoreo rivela un'espressione formale mutevole in base ai punti di osservazione. La versione verniciata esternamente, sottolinea il carattere a tutto tondo del lavabo evidenziando la perfetta geometria circolare della sommità.

Opens like the stem of a flower, it is surprising for its organic form and how it characterizes the space, without being too intrusive.

It develops into height from a round base to open up and accept with an enveloping gesture the flow of water. Tuba, made from Cristalplant, leads to an extremely natural and sophisticated atmospheres with elements with a strong visual impact. In the freestanding version proposes a diagonal section that gives a new aspect to the edge of the basin, while its sculptural appearance reveals a changing formal expression based on the observation points. The external lacquered version, emphasizes the character highlighting the perfect circular geometry of the summit.





LAVABI FREESTANDING
FREESTANDING SINKS





Verniciabile esternamente in tutti i colori del nostro campionario
Can be externally lacquered in all colors of our collection

LAVABI FREESTANDING
 FREESTANDING SINKS

	H	Ø	art.
Flumood	90	50,4	TUBAMOOD
Cristalplant	90	50,4	TUBA3

Lavabo da terra in Cristalplant o Flumood con scarico a pavimento, completo di piletta con scarico libero, sifone e tubo flessibile.

Freestanding Cristalplant or Flumood sink with floor drainage complete with open plug, siphon and flexible tube.

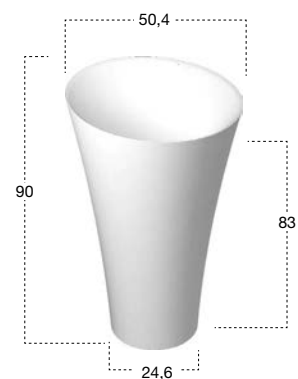

TENDER

_2004

design
Carlo
Colombo

Un'originale forma schiacciata, una profondità contenuta, un'immagine inedita per un lavabo freestanding dalla sezione rettangolare addolcita da morbide linee curve. All'inizio c'è un effetto sorpresa, quasi di spaesamento perché al tradizionale asse verticale dei lavabi freestanding viene associato uno sviluppo longitudinale. Poi l'immagine di Tender ritorna amica, conosciuta come quella di un vaso in cui la geometria del rettangolo viene ammorbidita da angoli smussati e linee leggermente arcuate. Un oggetto monolitico, dalla staticità assoluta, che muta il proprio aspetto e le proprie valenze espressive quando viene proposto in Cristalplant o in pietra, con la quale ritorna l'immagine del blocco scavato dall'acqua e plasmato dalle mani sapienti dell'uomo.

An original flat shape, deep, unexpected image for a freestanding washbasin with a rectangular section softened by soft curved lines. At the beginning there is a surprise, almost of bewilderment because the traditional vertical axis of freestanding basins is associated to a longitudinal development. Then the image of Tender returns friend, known as that of a vessel in which the rectangular geometry is softened by rounded corners and slightly curved lines. A monolithic object, from the absolute stillness, that changes its appearance and its expressive power when it is proposed in Cristalplant or stone, with which returns the image of a block carved by water and shaped by the hands of artisans.





Verniciabile esternamente in tutti i colori del nostro campionario
Can be externally lacquered in all colors of our collection

LAVABI FREESTANDING
 FREESTANDING SINKS

H	P	L	art.
85	41	72	TENDER

Lavabo da terra in Cristalplant con scarico a pavimento, completo di piletta con scarico a pressione klik-clak, sifone e tubo flessibile.

Freestanding Cristalplant sink with floor drainage complete with pressure plug, siphon and flexible hose.

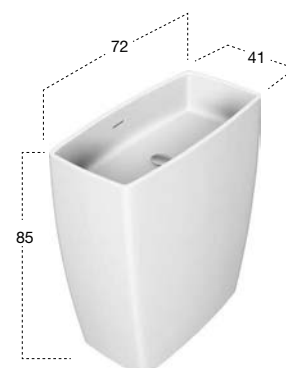

BARREL

_2003

design
Carlo
Colombo

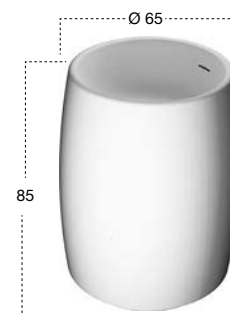

LAVABI FREESTANDING
FREESTANDING SINKS

H	Ø	art.
85	65	BARREL3

Lavabo da terra in Cristalplant con scarico a pavimento, completo di piletta con scarico a pressione clik-clak, sifone e tubo flessibile.

Freestanding Cristalplant sink with floor drainage complete with pressure plug, siphon and flexible hose.

MR.SPLASH

_2009

design
Jorge
Bibiloni





Ironico, divertente, fuori dagli schemi. Pochi gesti: uno schermo arcuato e un piano inclinato che lo incontra, per una forma che nasconde un bacino dalle dimensioni contenute e lo rivela solo lateralmente. L'acqua scorre sul piano inclinato a sbalzo come su un lavatoio, la gravità la trascina verso il bacino ma a un certo punto scompare dalla nostra vista. Uno schermo arcuato, un diaframma protegge il suo flusso e nasconde il bacino, proteggendo un bene così prezioso. L'immagine è ironica e inusuale, la genesi lascia spazio a diverse interpretazioni, la forma è determinata dall'intersezione di geometrie diverse. Mr. Splash è un lavabo freestanding dallo spessore contenuto, un oggetto dinamico che cattura l'attenzione e invita ad avvicinarsi, a guardare dentro...

Ironic, fun, outside of the box. Few gestures: an arched screen and an inclined plane which meets for a form that hides a basin with small dimensions and only the side reveals. Water flows on the inclined plane, gravity drags her toward the basin, but at some point disappears from sight. An arched screen, a diaphragm protects its flow and conceals the basin, protecting such a precious resource. The image is ironic and unusual, the genesis leaves room for different interpretations, the shape is determined by the intersection of different geometries. Mr. Splash is a freestanding washbasin by reduced thickness, dynamic object that captures the attention and invites them to approach, to look inside ...

LAVABI FREESTANDING
FREESTANDING SINKS

H	P	L	art.
100	44	72	MR.SPLASH

Lavabo da terra in Cristalplant con scarico a pavimento, completo di piletta con scarico libero, sifone e tubo flessibile.

Freestanding Cristalplant sink with floor drainage complete with open plug, siphon and flexible hose.

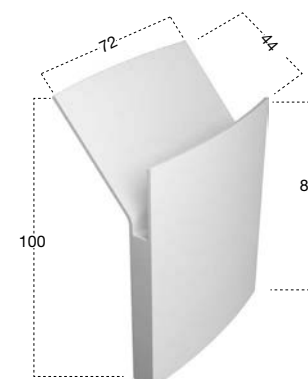



LAVABI *SINKS*

INTROVERSO

_2016

design
Paolo
Ulian

Modello e design registrato, brevetto depositato
Registered model and design, patent filed



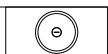

P 54

LAVABI
SINKS

	H	Ø	art.
Marmo Carrara	16	45	INTROVERSO45

Lavabo tondo sopra piano in pietra, completo di piletta con scarico libero e raccordo per sifone.

Round top mount stone sink complete with drain pipe fitting and open plug.

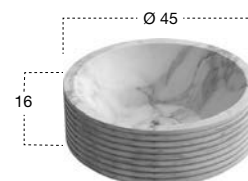

PIXEL

_2016

design
Paolo
Ulian

Modello e design registrato, brevetto depositato
Registered model and design, patent filed





P 54

	H	Ø	art.
Marmo Carrara	11	45	PIXEL45

Lavabo tondo sopra piano in pietra, completo di piletta con scarico libero e raccordo per sifone.

Round top mount stone sink complete with drain pipe fitting and open plug.

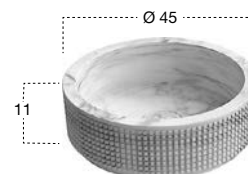

Eccellenza della materia, tecnologie di lavorazione evolute, creatività e riferimenti al mondo della moda: sono questi i temi indagati dal progetto Gessato, la collezione di lavabi da appoggio che ripropone il motivo delle righe parallele che identifica alcuni capi di abbigliamento. Una collezione che nasce dalla creatività e dal pensiero dell'uomo e si realizza attraverso la precisione della macchina, un volume morbido e sinuoso dalle linee avvolgenti ottenuto accostando lamine di marmo da 2 cm di Carrara incollate fra loro tramite una resina colorata.

Proprio la variazione cromatica e il contrasto che si viene a creare tra materiale naturale e collante conferisce il caratteristico motivo a righe alternate alla superficie, mentre la perfetta levigatura del volume dona all'insieme un effetto optical di grande fascino. Tondo, ovale o quadrato, Gessato porta nell'ambiente bagno dinamismo e personalità, grazie alle linee parallele che si rincorrono sulle superfici curve per definire nuove prospettive e direzioni. La straordinaria personalità del marmo e le sue infinite declinazioni cromatiche rendono ogni lavabo unico e irripetibile.

Excellence in the subject, advanced processing technologies, creativity and references to the world of fashion: these are the themes investigated by the Gessato project, the collection of top mount sinks that reproduce the motif of parallel lines that identify some items of clothing. A collection that comes from the creativity and thinking of man and is achieved through the precision of the machine, a soft and sinuous volume with enveloping lines obtained by combining 2 cm of Carrara marble sheets glued together by means of a colored resin.

Just the chromatic variation and the contrast that is created between natural material and glue gives a pattern with alternating stripes along the surface, while the perfect sanding of the volume gives an optical effect of great charm. Round, oval or square, Gessato brings energy and personality to the bathroom, thanks to the parallel lines that run on curved surfaces to define new perspectives and directions. The extraordinary personality of marble and its infinite chromatic variations make each sink unique and unrepeatable.



LAVABI
SAMS





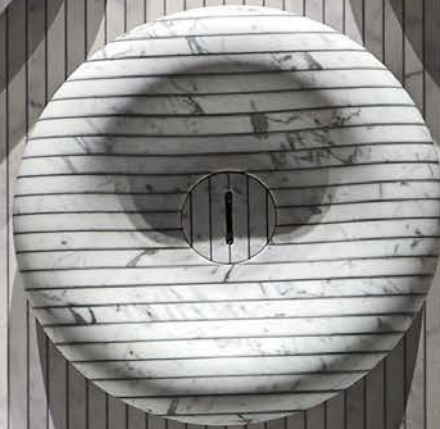
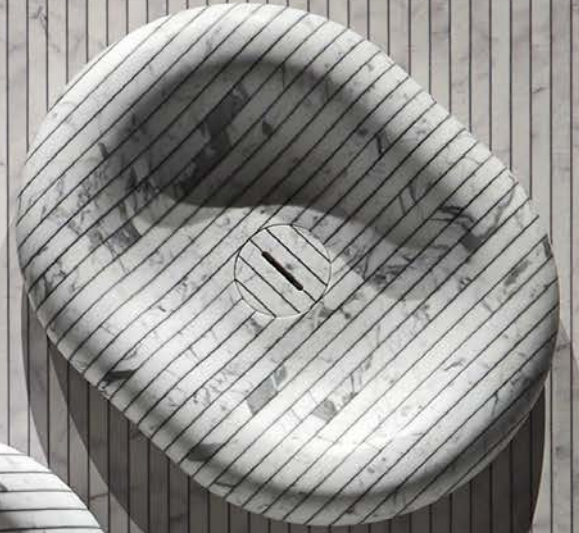

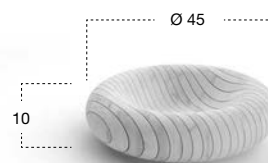

	H	Ø	art.
Marmo Carrara	10	45	CESSATI45

Lavabo tondo sopra piano in pietra, completo di piletta con scarico libero e raccordo per sifone.

Round top mount stone sink complete with drain pipe fitting and open plug.

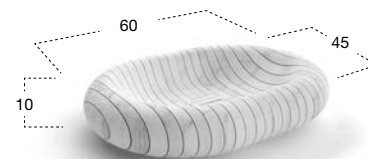

	H	P	L	art.
Marmo Carrara	10	45	60	CESSATI60

Lavabo ovale sopra piano in pietra, completo di piletta con scarico libero e raccordo per sifone.

Oval top mount stone sink complete with drain pipe fitting and open plug.

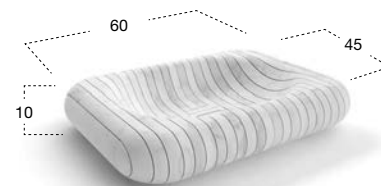

	H	P	L	art.
Marmo Carrara	10	45	60	CESSATI160

Lavabo rettangolare sopra piano in pietra, completo di piletta con scarico libero e raccordo per sifone.

Rectangular top mount stone sink complete with drain pipe fitting and open plug.





BLOKKO

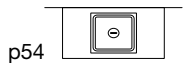
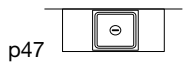
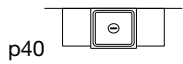

	H	P	L	art.
Marmo Carrara	15,5	45	45	BLOKKO

Lavabo quadro sopra piano in pietra, completo di piletta con scarico libero e raccordo per sifone.

Square top mount stone sink, complete with drain pipe fitting and open plug.

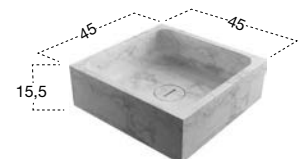



Pietra Luna

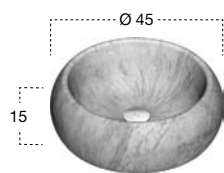
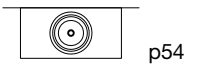

H	Ø	art.	
15	45	BULL	Pietra Luna

Lavabo tondo sopraiano in pietra, completo di piletta con scarico libero e raccordo per sifone.

Round top mount stone sink complete with drain pipe fitting and open plug.



Pietra Luna



LAVABI
SINKS

	H	Ø	art.
Pietra Luna / Pietra Vesuvio / Nero Marquina	15	50	PILA11

Lavabo tondo sopraiano in pietra, completo di piletta con scarico libero e raccordo per sifone.

Round top mount stone sink complete with drain pipe fitting and open plug.

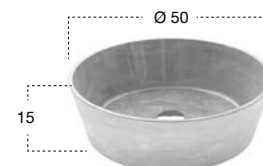

LAVANDINO

_2017

design
Francesca Braga Rosa
Ivano Vianello





Sottile come un foglio, essenziale come una figura geometrica bidimensionale, leggero ma solido, all'apparenza sospeso in aria ma in realtà ben ancorato alla parete. Minimale ma espressivo.

Il nome è volutamente semplice, quasi ingenuo, facilmente associabile alla sua funzione, il tratto è essenziale, il materiale non usuale. La semplicità di un foglio piegato e la purezza dell'acciaio inox sono l'ispirazione di Lavandino, il lavabo dalla forma nitida, dalla geometria assoluta, dal rigore che si trasforma in espressività. Geometria assoluta anche per il rubinetto rettangolare e le manopole cilindriche, collocati in posizione asimmetrica per esaltare il senso di dinamismo trasmesso dall'immagine complessiva del lavabo.

Sembra sospeso ma nasconde una tecnologia avanzata che permette al lavabo di integrarsi alla parete grazie a un telaio, che funge da dima per la finitura, e che consente l'alloggio della cartuccia del rubinetto. La leggerezza è immediata, la perfetta continuità del materiale è garantita da saldature eseguite a regola d'arte, l'acqua viene fatta defluire da un taglio sulla superficie che sottolinea il linguaggio essenziale del progetto.

Thin as a sheet of paper, essential as a two-dimensional geometric shape, light but solid, seemingly suspended in the air but really well anchored to the wall. Minimal yet expressive.

The name is deliberately simple, almost naive, easily associated to its function, essential lines, the unusual material. The simplicity of a folded sheet and the purity of stainless steel are the inspiration for Lavandino, the sink with a sharp shape, absolute geometry, rigor that transforms into expressiveness. Absolute geometry even for the rectangular tap and the cylindrical knobs, placed in an asymmetrical position to enhance the sense of the dynamics transmitted from the overall image of the sink.

It seems suspended but hides an advanced technology that allows the sink to integrate to the wall thanks to a frame, which serves as a template for the finishing, and that allows the accommodation of the faucet cartridge. Lightness is immediate, the perfect continuity of the material is guaranteed by welding performed in a workmanlike manner, the water is allowed to flow from a cut on the surface that emphasizes the essential language of the project.

LAVABI
SINKS

H	P	L	art.
27,5	44,5	72	LAVANDINO

Lavabo rettangolare da parete in acciaio inox AISI 316/L completo di rubinetteria, scarico libero e raccordo per sifone.

Rectangular wall mount stainless steel AISI 316/L sink, complete with tap, drain pipe fitting and open plug.

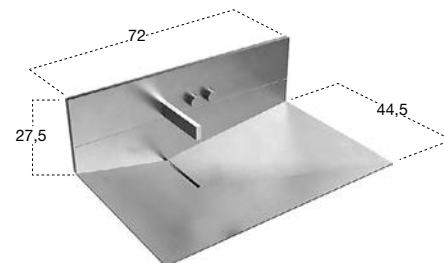

RIM

_2018

design
Daniel Debiasi
Federico Sandri

Tondo o ovale, Rim è il nuovo lavabo ultrasottile che ha nella morbidezza e nella continuità del bordo il proprio tratto distintivo. Come una foglia leggera che si adagia su uno specchio d'acqua Rim si appoggia sul piano con delicatezza, quasi a sfiorare la superficie. La profondità ridotta del bacino e la sezione continua che si completa con un bordo arrotondato conferiscono contemporaneamente all'insieme. Il volume sottile del lavabo riporta idealmente alla bidimensionalità della geometria generatrice, sottolineata dallo specchio d'acqua che si verrà a creare al suo interno.

Round or oval, Rim is the new ultra-thin sink that has its own distinctive feature in the softness and continuity of the border. Like a light leaf that lies on a mirror of water, Rim rests gently on the surface, almost touching the surface. The reduced depth of the bowl and the continuous section which is completed with a rounded edge give the whole a contemporary appearance. The subtle volume of the sink ideally returns to the two-dimensionality of the generating geometry, underlined by the mirror of water that will be created inside.



LAVABI
S/MKS



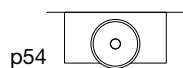
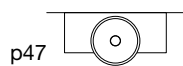

H	Ø	art.
13,6	54	RIM54

Lavabo tondo sopra piano in Flumood, completo di piletta con scarico libero e raccordo per sifone.

Round top mount Flumood sink, complete with drain pipe fitting and open plug.

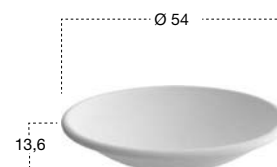

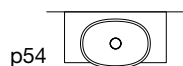
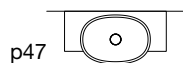

LAVABI
SINKS

H	P	L	art.
13,6	54	76	RIM76

Lavabo ovale sopra piano in Flumood completo di piletta con scarico libero e raccordo per sifone.

Oval top mount Flumood sink complete with drain pipe fitting and open plug.



VELO

_2018

design
Mario
Ferrarini

Versatile, trasversale, perfetta per inserirsi in contesti diversi di stile. La collezione di lavabi Velo, disponibile nelle forme tonda, ovale e rettangolare, si aggiorna per incontrare il gusto contemporaneo. Nel rispetto del concept originale, delle geometrie e delle dimensioni della serie, i bordi si fanno però più sottili di 5 mm conferendo maggiore leggerezza all'insieme e allo stesso tempo garantendo un maggior volume del bacino. Rimane invariata la caratteristica forma delle versioni tonda e ovale con la base d'appoggio molto stretta e il bacino molto più ampio, mentre nella versione rettangolare con spigoli arrotondati il volume è perfettamente ortogonale.

Versatile, transversal, perfect to fit in different environments. The Velo washbasin collection, available in round, oval and rectangular shapes, is updated to meet a contemporary inclination. Considering the original concept, geometry and dimensions of the series, the edges are 5 mm giving greater lightness to the whole and at the same time ensuring a greater volume of the basin. The typical round and oval shapes remain unmodified with a very narrow base for support and a wider bowl, while the rectangular version with rounded corners has a perfectly perpendicular volume.



LAVABI
SINKS



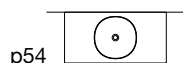
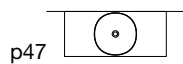
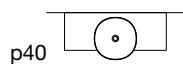

Verniciabile esternamente in tutti i colori del nostro campionario
Can be externally lacquered in all colors of our collection

LAVABI
 SINKS

H	P	L	art.
15	45	45	VELOTONDO45

Lavabo tondo sopra piano in Flumood, completo di piletta con scarico libero e raccordo per sifone.

Round top mount Flumood sink, complete with drain pipe fitting and open plug.





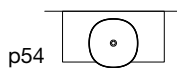

Verniciabile esternamente in tutti i colori del nostro campionario
Can be externally lacquered in all colors of our collection

LAVABI
 SINKS

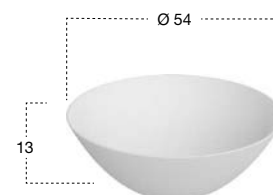

H	Ø	art.
13	54	VELOTOND054

Lavabo tondo sopra piano in Flumood, completo di piletta con scarico libero e raccordo per sifone.

Oval top mount Flumood sink, complete with drain pipe fitting and open plug.





VEL054

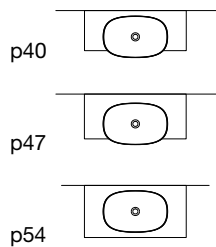

VEL063

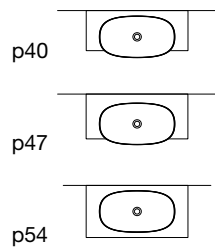

Verniciabile esternamente in tutti i colori del nostro campionario
Can be externally lacquered in all colors of our collection

LAVABI
 SINKS

H	P	L	art.
15	35	54	VEL054
15	35	63	VEL063

Lavabo ovale sopra-piano in Flumood, completo di piletta con scarico libero e raccordo per sifone.

Oval top mount Flumood sink, complete with drain pipe fitting and open plug.

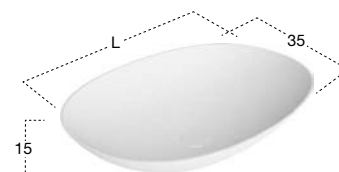

SENSO

_2015

design
Nevio
Tellatin

Morbido, avvolgente, sinuoso, con un bordo sottilissimo a definirne il volume. Una forma resa possibile dallo straordinario livello raggiunto nella lavorazione del Flumood.

Parte da una geometria rettangolare che si addolcisce sia in pianta che in sezione, originando linee sinuose che danno vita a un lavabo avvolgente e dall'immagine morbida. Senso è contemporaneo per carattere, equilibrio perfetto delle proporzioni e materiale utilizzato, caratteristiche che ne permettono l'inserimento in qualsiasi contesto nel quale porta la propria eleganza e leggerezza formale.

Soft, enveloping, sinuous with a thin border to define its volume. A shape obtained by the extraordinary level achieved in the workmanship of Flumood. A rectangular shape that softens both in plan or in section. Senso is contemporary by nature, a perfect balance between proportions and material used, features that allow its insertion in any context contributing elegance and lightness.





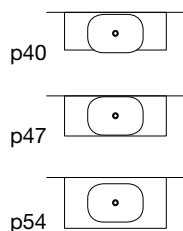

Verniciabile esternamente in tutti i colori del nostro campionario
Can be externally lacquered in all colors of our collection

LAVABI
 SINKS

H	P	L	art.
15	40	60	SENSO

Lavabo rettangolare sopra piano in Flumood completo di piletta con scarico libero e raccordo per sifone.

Rectangular top mount Flumood sink complete with drain pipe fitting and open plug.



AGO

_2013

design
Mario
Ferrarini







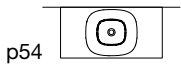
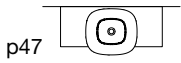
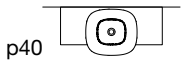

Verniciabile esternamente in tutti i colori del nostro campionario
Can be externally lacquered in all colors of our collection

H	P	L	art.
15	45	50	AG03

Lavabo ovale sopraiano in Flumood completo di piletta con scarico libero e raccordo per sifone.

Oval top mount Flumood sink complete with drain pipe fitting and open plug.



SIMPLO

_2015

design
Mario
Ferrarini

Modello e design registrato, brevetto depositato
Registered model and design, patent filed



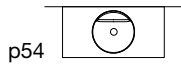
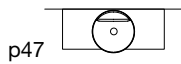
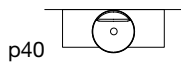

OPTIONAL
Troppopieno
Overflow

Verniciabile esternamente in tutti i colori del nostro campionario
Can be externally lacquered in all colors of our collection

LAVABI
SINKS



H	Ø	art.
11	45	SIMPLONDONO

Lavabo tondo sopra piano in Flumood completo di piletta con scarico libero e raccordo per sifone.

Round top mount Flumood sink complete with drain pipe fitting and open plug.



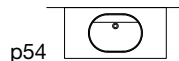
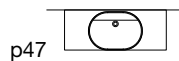
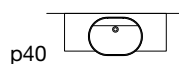

OPTIONAL
Troppopieno
Overflow

Verniciabile esternamente in tutti i colori del nostro campionario
Can be externally lacquered in all colors of our collection

LAVABI
SINKS

H	P	L	art.
11,3	45	63	SIMPLOVALE

Lavabo ovale sopra piano in Flumood, completo di piletta con scarico libero e raccordo per sifone.

Oval top mount Flumood sink, complete with drain pipe fitting and open plug.





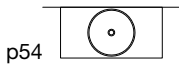
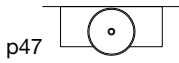
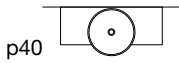

Verniciabile esternamente in tutti i colori del nostro campionario
Can be externally lacquered in all colors of our collection

LAVABI
 SINKS

H	Ø	art.
12	50	VERSO

Lavabo tondo sopraiano in Flumood completo di piletta con scarico libero e raccordo per sifone.

Round top mount Flumood sink complete with drain pipe fitting and open plug.

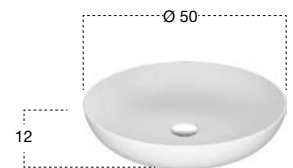



CATINO Ø 50 cm



CATINO43 Ø 43 cm

CATINO43

CATINO

Verniciabile esternamente in tutti i colori del nostro campionario
Can be externally lacquered in all colors of our collection

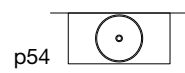
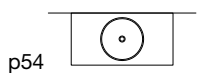
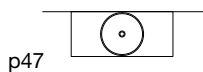

LAVABI
SINKS

H	Ø	art.
15	43	CATINO43
15	50	CATINO



Lavabo tondo sopra piano in Flumood completo di piletta con scarico libero e raccordo per sifone.

Round top mount Flumood sink complete with drain pipe fitting and open plug.

SERVO

_2010

design
Mario
Ferrarini



lavabo SERV054 in CERAMILUX®
CERAMILUX® sink SERV054



lavabo SERV000D54 in FLUMOOD®
FLUMOOD® sink SERV000D54

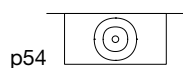
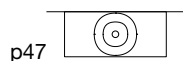
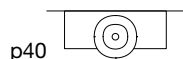

	H	P	L	art.
Ceramilux	12,5	35	35	SERV035
Ceramilux	15	45	45	SERV045
Flumood	15	45	45	SERVOM00D45

Lavabo tondo sopra piano in Ceramilux o Flumood, completo di piletta con scarico libero e raccordo per sifone.

Round top mount Ceramilux or Flumood sink, complete with drain pipe fitting and open plug.

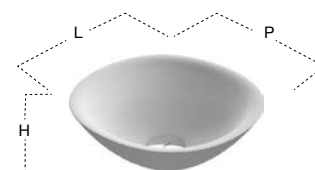

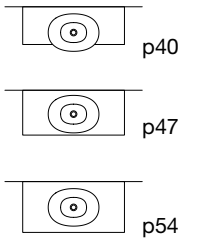

H	P	L	art.	
15	40	54	SERV054	Ceramilux
15	40	54	SERV00054	Flumood

Lavabo ovale sopra piano in Ceramilux o Flumood, completo di piletta con scarico libero e raccordo per sifone.

Oval top mount Ceramilux or Flumood sink, complete with drain pipe fitting and open plug.

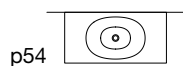
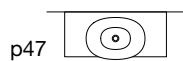
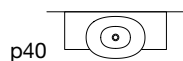

	H	P	L	art.
Ceramilux	15	45	63	SERV063
Flumood	15	45	63	SERV000D63

Lavabo ovale sopra piano in Ceramilux o Flumood, completo di pileta con scarico libero e raccordo per sifone.

Oval top mount Ceramilux or Flumood sink, complete with drain pipe fitting and open plug.

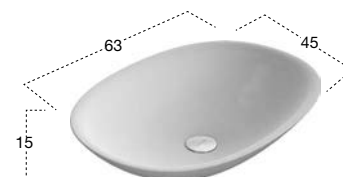

PIPER

_2006

design
Carlo
Colombo

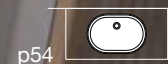



LAVABI
SINKS

H	P	L	art.
12	42	63	PIPER1

Lavabo ovale sopra piano o sottopiano in Ceramilux completo di piletta con scarico libero e raccordo per sifone.

Oval top or undermount Ceramilux sink, complete with drain pipe fitting and open plug.



BULBO

_2006

design
Carlo
Colombo



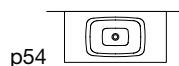
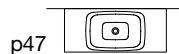

H	P	L	art.
15	42	63	BULBO

Lavabo rettangolare sopra piano a incasso in Ceramilux completo di piletta con scarico libero e raccordo per sifone.

Rectangular encased Ceramilux sink, complete with drain pipe fitting and open plug.





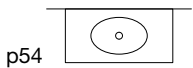
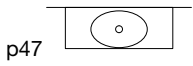
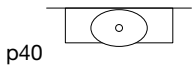

H	P	L	art.
15	46	68	SOLIDEA

Lavabo ovale sopra piano in Cristalplant completo di piletta con scarico libero e raccordo per sifone.

Oval top mount Cristalplant sink complete with drain pipe fitting and open plug.

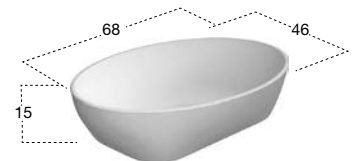

URNAMOOD

_2006

design
Carlo
Colombo



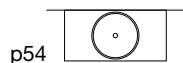
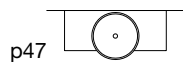
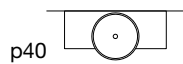

Verniciabile esternamente in tutti i colori del nostro campionario
Can be externally lacquered in all colors of our collection

LAVABI
 SINKS

H	Ø	art.
23,5	50	URNAMOOD

Lavabo tondo sopra piano in Flumood completo di piletta con scarico libero e raccordo per sifone.

Round top mount Flumood sink complete with drain pipe fitting and open plug.

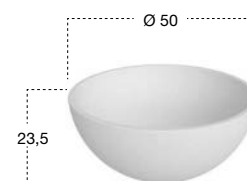



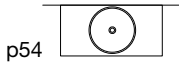
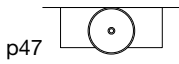
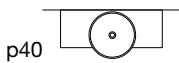

* Verniciabile esternamente in tutti i colori del nostro campionario
Can be externally lacquered in all colors of our collection

	H	Ø	art.
Ceramilux	20	50	SERVOTONDO
Flumood	20	50	TONDOMOOD *

Lavabo tondo sopra piano in Ceramilux o Flumood, completo di pileta con scarico libero e raccordo per sifone.

Round top mount Ceramilux or Flumood sink complete with drain pipe fitting and open plug.

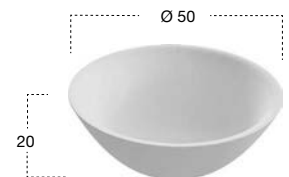



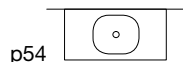
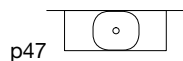
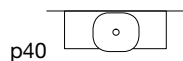

LAVABI
SINKS

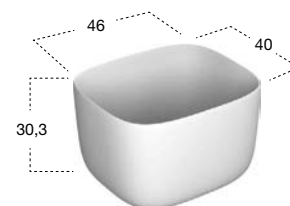

H	P	L	art.
30,3	40	46	POGGIO

Lavabo rettangolare sopraiano in Flumood completo di piletta con scarico libero e raccordo per sifone.

Rectangular top mount Flumood sink complete with drain pipe fitting and open plug.

BOLO

_2014

design
Mario
Ferrarini



Cos'è un lavabo se non un vaso contenente acqua a cui abbiamo aggiunto uno scarico? La tipica sezione a "collo di bottiglia" è il tratto distintivo della collezione Bolo e ne identifica tutti gli elementi. Le linee sono morbide e arrotondate, le geometrie essenziali, l'immagine complessiva discreta ma allo stesso tempo elegante: i lavabi da appoggio della collezione Bolo realizzati in Ceramilux e Flumood sono presenze amiche e confortanti che ci accompagnano nell'ambiente bagno trasmettendoci una sensazione di leggerezza e di sofisticata pulizia estetica. Bolo, che nella forma gergale delle ceramiche artistiche indica il vaso, riprende volutamente l'origine dell'impasto utilizzato nella realizzazione del ciotolame, per evidenziare un immaginario percorso evolutivo dalle sue origini alle nuove tecnologie della produzione in serie. Quattro lavabi caratterizzati da spessori minimi declinati nelle forme geometriche elementari: dal cerchio al quadrato, dal rettangolo all'ovale. I diversi modelli per installazione sopra piano sono accomunati dalla sezione eccezionalmente esile e dal copri piletta integrato con il bacino. La base si restringe rispetto al volume del bacino dei lavabi, così che questi risultino quasi sospesi, come se galleggiasse nell'aria invece di essere appoggiati su un piano. Si ha la sensazione che questi elementi si possano muovere da un momento all'altro su un cuscinetto d'aria e lievitare... eterei come nuvole ma in realtà solidi e concreti come pietre.

What is a sink if not a vessel containing water to which we added a drain? The typical section to "bottleneck" is the hallmark of the Bolo collection and identifies all the elements. The lines are soft and rounded, basic geometry, a discrete overall image at the same time elegant: the washbasins of the Bolo collection made of Ceramilux and Flumood are send us a feeling of lightness and sophisticated clean lines.

Four sinks characterized by minimal thicknesses in elementary geometric shapes: circle, square rectangle and oval. The different models for top mounting are united by the exceptionally thin section and drain integrated in the basin. The base is narrowed compared to the volume of the basin so they seem almost suspended as if they were floating on air. One has the feeling that these elements can move at any moment on a cushion of air and rise ... ethereal as clouds but solid and concrete as stones.



BOL054
54 x 40 x 12,5 cm



BOL045
Ø 45 cm x 12,5 cm





BOL063
63 x 40 x 12,5 cm



BOL040
40 x 40 x 12,5 cm

LAVABI
SINKS

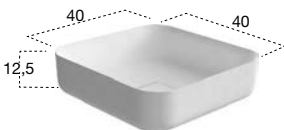
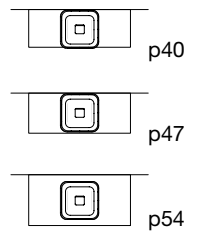

H	P	L	art.	
12,5	40	40	BOLO40	Ceramilux
12,5	40	40	BOLOMOOD40	Flumood

Lavabo quadrato sopra piano in Ceramilux o Flumood, completo di piletta con scarico libero e raccordo per sifone.

Square top mount Ceramilux or Flumood sink, complete with drain pipe fitting and open plug.

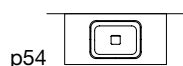
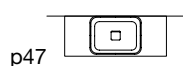
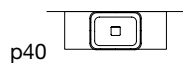

	H	P	L	art.
Ceramilux	12,5	40	54	BOLO54
Flumood	12,5	40	54	BOLOM00D54

Lavabo rettangolare sopra piano in Ceramilux o Flumood completo di piletta con scarico libero e raccordo per sifone.

Rectangular top mount Ceramilux or Flumood sink complete with drain pipe fitting and open plug.

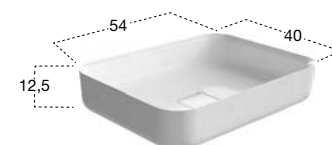

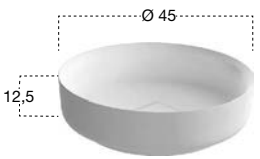
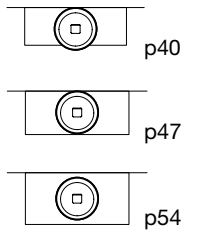

H	Ø	art.	
12,5	45	BOLO45	Ceramilux
12,5	45	BOLOM00D45	Flumood

Lavabo tondo sopra piano in Ceramilux o Flumood, completo di piletta con scarico libero e raccordo per sifone.

Round top mount Ceramilux or Flumood sink, complete with drain pipe fitting and open plug.

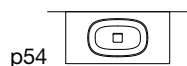
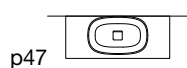
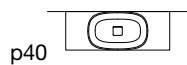

	H	P	L	art.
Ceramilux	12,5	40	63	BOLO63
Flumood	12,5	40	63	BOLOMOOD63

Lavabo ovale sopra piano in Ceramilux o Flumood completo di piletta con scarico libero e raccordo per sifone.

Oval top mount Ceramilux or Flumood sink complete with drain pipe fitting and open plug.



FOGLIO

_2013

design
Mario
Ferrarini



Un foglio, uno strato sottile di materia plasmata dall'acqua e piegata dalla gravità si adagia dolcemente su una superficie d'appoggio restando quasi sospesa a librarsi nell'aria.

Leggero come un foglio di carta, sospeso come una piuma che sembra solo lambire leggermente la superficie, addolcito dalla forza dell'acqua che ne ha modificato la planarità e trasformato la perfetta ortogonalità Foglio è un lavabo da semi incasso che presenta un bacino ampio e aperto e una base dalle dimensioni ridotte che quasi scompare alla vista amplificando ulteriormente la sensazione di sospensione rispetto al piano d'appoggio. Il volume non presenta soluzione di continuità, la depressione creata al centro del lavabo scava di fatto la materia e origina un bacino "naturale" nel quale raccogliere l'acqua.

A sheet, a thin layer of material formed from water and bent by gravity on a bearing surface remaining almost suspended to hover in the air. As light as a sheet of paper, suspended like a feather that seems only slightly lapping the surface, softened by the force of the water it has changed the flatness and transformed perfectly square Foglio is a semi recessed basin with a large and open basin and a base of reduced dimensions that almost disappears from view further amplifying the feeling of suspension with respect to the top.

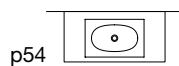
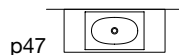

	H	P	L	art.
Ceramilux	14	40,4	63	FOGLIO63
Flumood	14	40,4	63	FOGLIOMOOD63

Lavabo rettangolare sopra piano ad incasso in Ceramilux o Flumood, completo di piletta con scarico libero e raccordo per sifone.

Rectangular encased Ceramilux or Flumood sink, complete with drain pipe fitting and open plug.

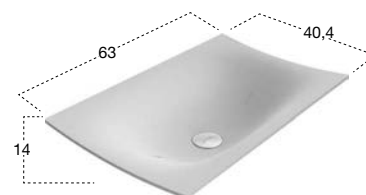

BLOOM

_2018

design

Daniel Debiasi

Federico Sandri

Sottile come un foglio di carta, accogliente e profondo ma allo stesso tempo leggero e delicato. Bloom è il lavabo da appoggio dalla forma inedita che nasce da una geometria rigorosa ma si addolcisce enfatizzando la sottigliezza della materia e lo spessore del bordo che sembra annullarsi. Le linee morbide che si aprono salendo verso l'alto invitano all'utilizzo del lavabo e accompagnano i gesti, facilitando l'esperienza, mentre la base rimane importante e ben ancorata al piano. I 4 tagli negli angoli rimandano all'immagine di una scatola che si apre e diventano il segno distintivo della collezione. Dettagli semplici che si trasformano in decoro contemporaneo e contribuiscono alla trasposizione di significato del materiale. Il foglio sembra infatti strapparsi sottoposto alla forza dell'acqua ma in realtà l'involucro è resistente, solido e assicura una grande capacità al bacino.

Thin like a sheet of paper, cozy and deep but at the same time light and delicate. Bloom is the top mount basin with an original shape that comes from a rigorous geometry but softens emphasizing the subtlety of the material and the thickness of the border that seems to cancel out. The soft lines that open upwards invite the use of the sink and accompany the gestures, facilitating the experience, while the base remains important and well anchored to the top. The 4 cuts in the corners refer to the image of a box that opens and becomes the hallmark of the collection. Simple details that are transformed into contemporary decor and contribute to the transposition of the material's meaning. In fact, the sheet seems to tear off because subjected to the force of the water but in reality the casing is resistant, solid and ensures a great capacity to the basin.



LAVABI
SINKS



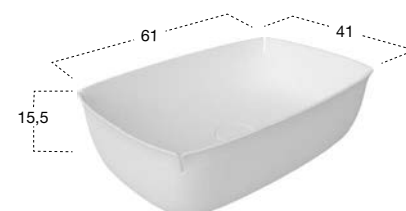
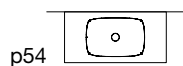
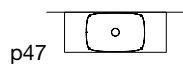
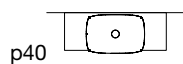

LAVABI
SINKS

H	P	L	art.
15,5	41	61	BLOOM

Lavabo rettangolare sopra piano in Flumood completo di piletta con scarico libero e raccordo per sifone.

Rectangular top mount Flumood sink complete with drain pipe fitting and open plug.

VELO

_2018

design
Mario
Ferrarini

Versatile, trasversale, perfetta per inserirsi in contesti diversi di stile. La collezione di lavabi Velo, disponibile nelle forme tonda, ovale e rettangolare, si aggiorna per incontrare il gusto contemporaneo. Nel rispetto del concept originale, delle geometrie e delle dimensioni della serie, i bordi si fanno però più sottili di 5 mm conferendo maggiore leggerezza all'insieme e allo stesso tempo garantendo un maggior volume del bacino.

Rimane invariata la caratteristica forma delle versioni tonda e ovale con la base d'appoggio molto stretta e il bacino molto più ampio, mentre nella versione rettangolare con spigoli arrotondati il volume è perfettamente ortogonale.

Versatile, transversal, perfect to fit in different environments. The Velo washbasin collection, available in round, oval and rectangular shapes, is updated to meet a contemporary inclination. Considering the original concept, geometry and dimensions of the series, the edges are 5 mm giving greater

lightness to the whole and at the same time ensuring a greater volume of the basin. The typical round and oval shapes remain unmodified with a very narrow base for support and a wider bowl, while the rectangular version with rounded corners has a perfectly perpendicular volume.



LAVABI
SINKS





VELORETT050

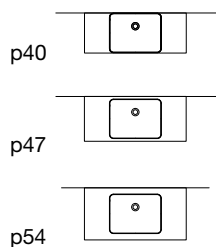

VELORETT063

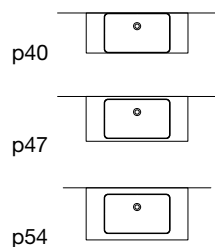

Verniciabile esternamente in tutti i colori del nostro campionario
Can be externally lacquered in all colors of our collection

	H	P	L	art.
	13	38	50	VELORETT050
	13	38	63	VELORETT063

Lavabo rettangolare sopra piano o sottopiano in Flumood, completo di piletta con scarico libero e raccordo per sifone.

Rectangular top mount or undermount Flumood sink, complete with drain pipe fitting and open plug.

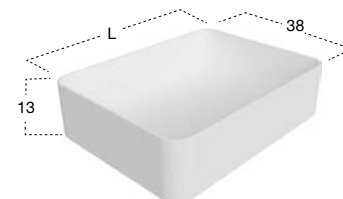





RETTOMOOD50
SERVORETTO50

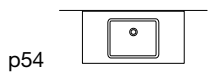
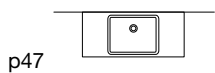
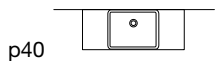

RETTOMOOD63
SERVORETTO63

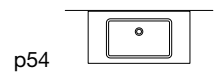
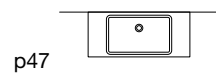
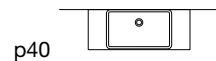

	H	P	L	art.
Ceramilux	13	38	50	SERVORETTO50
Ceramilux		38	63	SERVORETTO63
Flumood	13	38	50	RETTOMOOD50
Flumood		38	63	RETTOMOOD63

Lavabo rettangolare sopra piano o sottopiano in Ceramilux o Flumood completo di piletta con scarico libero e raccordo per sifone.

Rectangular top mount or undermount Ceramilux or Flumood sink complete with drain pipe fitting and open plug.

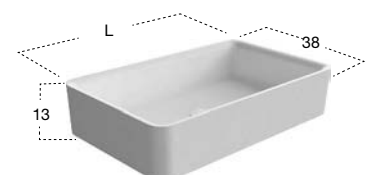

VENERE

_2017

design

Mario

Ferrarini

La sensualità della forma, la morbidezza delle linee avvolgenti, la continuità delle superfici, il fascino che diventa mistero, il conosciuto che nasconde l'ignoto.

Non poteva che chiamarsi Venere e rimandare in modo esplicito al concetto di bellezza, di grazia, di sensualità tutta femminile. L'immagine frontale del lavabo sospeso, rimanda immediatamente a quella di una bocca, la superficie vellutata del Flumood, amplifica i sensi coinvolgendo la tattilità oltre che la vista. Venere è magicamente ancorato alla parete, è perfettamente integrato con essa grazie alla parte posteriore del bacino che risale per coprire le componenti tecnologiche d'ancoraggio.

The sensuality of form, the softness of the enveloping lines, the continuity of the surfaces, the charm that becomes mystery, what is known hides the unknown.

It could only be called Venere (Venus) and postpones explicitly to the concept of beauty, grace and feminine sensuality. The front image of the suspended washbasin leads immediately to that of a mouth, the smooth surface of the Flumood amplifies the senses involving tact over sight. VENERE is magically anchored to the wall, it is perfectly integrated with it through the back that comes up to cover the support components.



LAVABI
SINKS





H	P	L	art.
18,2	53,2	72,4	VENERE

Lavabo ovale da parete in Flumood, completo di piletta con scarico libero e raccordo per sifone.

Oval wall mount Flumood sink, complete with drain pipe fitting and open plug.

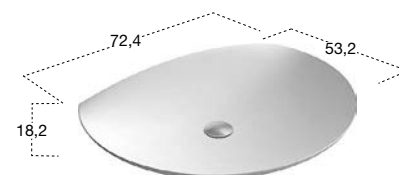

CANALE

_2017

design

Carlo

Colombo

Modello e design registrato, brevetto depositato

Registered model and design, patent filed

Un elemento tecnico che diventa componente espressiva, un dettaglio che identifica una collezione tanto da condizionarne il nome, un progetto che riassume le potenzialità infinite di un'azienda. Canale è il simbolo dell'approccio sartoriale di antoniolupi all'ambiente bagno, è un lavabo a parete realizzato interamente in Flumood, che si sviluppa in larghezza secondo le specifiche esigenze del cliente in un intervallo compreso tra 90 e 216 cm.

Le forme sono squadrate, nette e rigorose, lo sviluppo longitudinale è nel dna del prodotto, gli spessori sono contenuti grazie all'evoluzione tecnologica e all'impiego di questo straordinario materiale, la capienza del bacino è molto elevata. Il lavabo Canale unisce estetica e funzionalità proprio grazie al "canale" che è in realtà una comoda base d'appoggio rialzata sulla quale riporre accessori e tutto quanto è necessario per lo svolgimento delle azioni quotidiane nell'area lavabo.

A technical element that becomes an expressive component, a detail that identifies a collection so much as to affect the name, a project that summarizes the infinite potential of a company. Canale is the tailored approach, symbol of antoniolupi's bathroom environments, it is a wall-mounted washbasin made entirely in Flumood, which develops in width according to the specific needs of the client in a range between 90 and 216 cm.

The shapes are square, sharp and rigid, the longitudinal development is in the DNA of the product, the thicknesses are contained due to improved technology and the use of this extraordinary material, the capacity of the basin is very high. The basin Canale combines aesthetics and functionality thanks to the actual "channel" that it is, a convenient surface on which to store accessories and everything necessary for everyday usage.



LAVABI
SINKS





OPTIONAL
Troppieno
Overflow



Art. PIANETTO

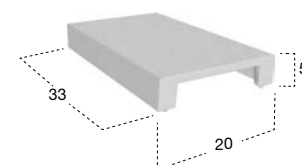

Art. CANALE

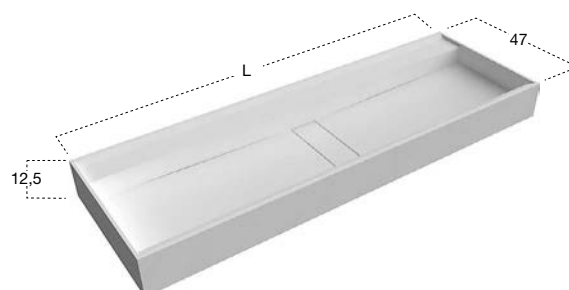

H	P	L	art.
5	33	20	PIANETTO

Pianetto optional copripiletta in Flumood finitura Satin.

Optional Flumood drain cover in satin finish.

H	P	L	art.
12,5	47	?	CANALE

Lavabo rettangolare da parete in Flumood, completo di piletta con scarico libero e raccordo per sifone.
(L da 90 cm a 216 cm)

Rectangular wall mount Flumood sink, complete with drain pipe fitting and open plug.
(L from 90 to 216 cm)

STRATOS

_2017

design
Mario
Ferrarini

Le linee nette e le geometrie rigorose del volume esterno si addolciscono nella morbida fluidità del bacino. Stratos è una commistione di due anime che si integrano in modo elegante in un'immagine armonica, è un perimetro rigido che esprime sicurezza e solidità proteggendo una superficie organica che si sviluppa al suo interno e si estende senza soluzione di continuità.

Una forma scultorea, un volume idealmente scavato dalla forza primordiale dell'acqua. Stratos è un lavabo realizzato in Flumood, il materiale brevettato da antoniolupi, e disponibile nella forma quadrata o rettangolare in due diverse altezze (12,5 e 18,8 cm). Stratos può essere appoggiato su un piano o sospeso a parete.

The sharp lines and the rigorous external geometrical shapes are softened with the fluidness of the internal shape of the basin. Stratos is a mixture of two souls integrated in an elegant and harmonious manner. It's rigid perimeter expresses safety and solidity protecting an organic interior that extends without interruption.

A sculptural shape, a volume ideally dug from the primordial force of water. Stratos is a washbasin made in Flumood, material patented by antoniolupi, and available in a square or rectangular shape in two different heights (12,5 and 18,8 cm). Stratos can be top mounted or wall mounted.



1



2



3



4

- 1 Art. STRATOS1 H 12,5 P 40 L 40 cm
- 2 Art. STRATOS2 H 12,5 P 40 L 63 cm
- 3 Art. STRATOS3 H 18,8 P 40 L 40 cm
- 4 Art. STRATOS4 H 18,8 P 40 L 63 cm

STRATOS1

L 40 P 40 H 12,5

STRATOS3

L 40 P 40 H 18,8



STRATOS2

L 63 P 40 H 12,5

STRATOS4

L 63 P 40 H 18,8



LAVABI
SINKS

STRATOS



Verniciabile esternamente in tutti i colori del nostro campionario
Can be externally lacquered in all colors of our collection

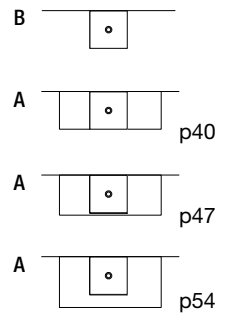
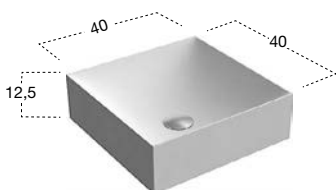

H	P	L	art.
12,5	40	40	STRATOS1

Lavabo quadrato sopra piano (A) o da parete (B) in Flumood, completo di piletta con scarico libero e raccordo per sifone.

Square top mount (A) or wall (B) mount Flumood sink, complete with drain pipe fitting and open plug.

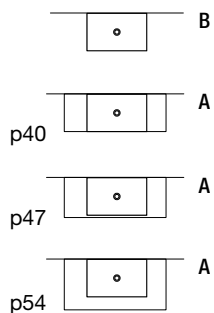

Verniciabile esternamente in tutti i colori del nostro campionario
Can be externally lacquered in all colors of our collection

LAVABI
 SINKS

H	P	L	art.
12,5	40	63	STRATOS2

Lavabo rettangolare sopra piano (A) o da parete (B) in Flumood, completo di piletta con scarico libero e raccordo per sifone.

Rectangular top mount (A) or wall mount (B) Flumood sink, complete with drain pipe fitting and open plug.

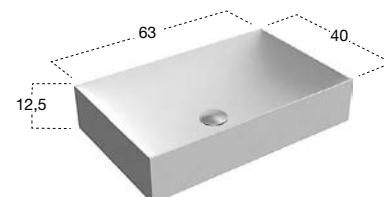

STRATOS



Verniciabile esternamente in tutti i colori del nostro campionario
Can be externally lacquered in all colors of our collection

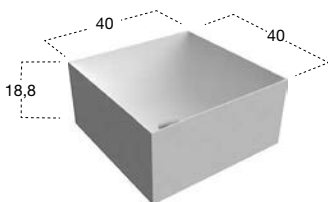
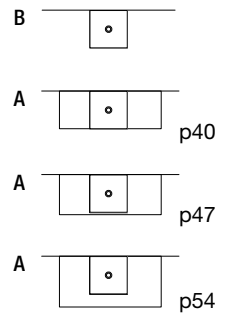

H	P	L	art.
18,8	40	40	STRATOS3

Lavabo quadrato sopra piano (A) o da parete (B) in Flumood, completo di piletta con scarico libero e raccordo per sifone.

Square top mount (A) or wall mount (B) Flumood sink, complete with drain pipe fitting and open plug.

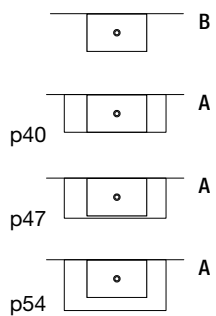

Verniciabile esternamente in tutti i colori del nostro campionario
Can be externally lacquered in all colors of our collection

H	P	L	art.
18,8	40	63	STRATOS4

Lavabo rettangolare sopra piano (A) o da parete (B) in Flumood, completo di piletta con scarico libero e raccordo per sifone.

Rectangular top mount (A) or wall mount (B) Flumood sink, complete with drain pipe fitting and open plug.

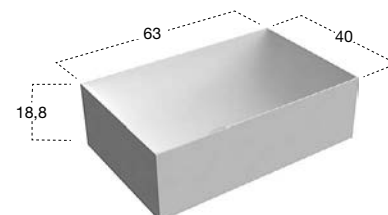

SIMPLO

_2015

design
Mario
Ferrarini

Modello e design registrato, brevetto depositato
Registered model and design, patent filed



Eleganti nel perfetto equilibrio delle proporzioni, minimali nella definizione complessiva della forma ma allo stesso tempo organici: i Simplo sono perfetti nell'interpretare attraverso i bordi sottili e gli angoli curvi, le ultime tendenze in materia di interior design e di progettazione di elementi che compongono l'ambiente bagno. La sottigliezza dei bordi permette inoltre di sfruttare al massimo la capacità del bacino, mentre il comodo piano d'appoggio, amplifica la funzionalità del lavabo e del lavamani. I Simplo sono realizzati interamente in Flumood. Il lavamani può essere appeso a parete o appoggiato su un piccolo mobile e può trovare posto all'interno di nicchie, vani o bagni di servizio.

Elegant in their perfectly balanced proportions, minimal in their overall definition of form but at the same time organic: the Simplo basins are perfect in interpreting thin edges and curved corners, the latest trends in interior design and elements of design that make up the bathroom environment. The subtle edges allow you to take advantage of the full capacity of the basins, while the comfortable surface amplifies their functionality. Simplo are made entirely in Flumood. These washbasins can be hung on the wall or top mounted on a small cabinet and can find a place in niches or guest bathrooms.





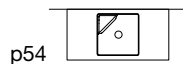
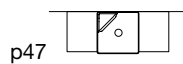
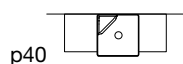

Verniciabile esternamente in tutti i colori del nostro campionario
Can be externally lacquered in all colors of our collection

LAVABI
 SINKS

H	P	L	art.
11	42	42	SIMPL042

Lavabo quadrato sopra piano dx o sx in Flumood completo di piletta con scarico libero e raccordo per sifone.

Right or left hand square top mount Flumood sink complete with drain pipe fitting and open plug.





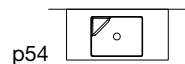
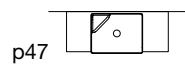
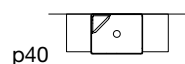

OPTIONAL
Troppopieno
Overflow



Verniciabile esternamente in tutti i colori del nostro campionario
Can be externally lacquered in all colors of our collection

H	P	L	art.
11	42	54	SIMPL054

Lavabo rettangolare sopra piano in Flumood completo di piletta con scarico libero e raccordo per sifone.

Rectangular top mount Flumood sink complete with drain pipe fitting and open plug.

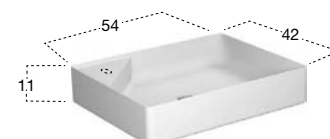



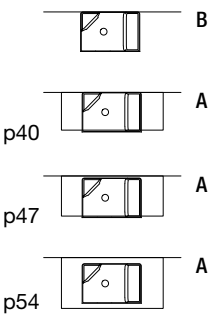

OPTIONAL
Troppieno
Overflow



Verniciabile esternamente in tutti i colori del nostro campionario
Can be externally lacquered in all colors of our collection

H	P	L	art.
11	42	63	SIMPL063

Lavabo rettangolare sopra piano (A) o da parete (B) in Flumood completo di piletta con scarico libero e raccordo per sifone.

Rectangular top mount (A) or wall mount (B) Flumood sink complete with drain pipe fitting and open plug.

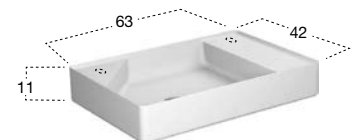



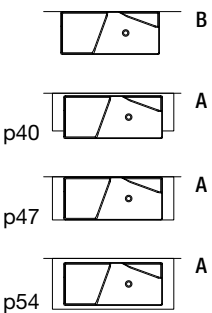

OPTIONAL
Troppopieno
Overflow



Verniciabile esternamente in tutti i colori del nostro campionario
Can be externally lacquered in all colors of our collection

H	P	L	art.
11	47	108	SIMPL0108

Lavabo rettangolare sopra piano (A) o da parete (B) in Flumood completo di piletta con scarico libero e raccordo per sifone.

Rectangular top mount (A) or wall mount (B) Flumood sink complete with drain pipe fitting and open plug.

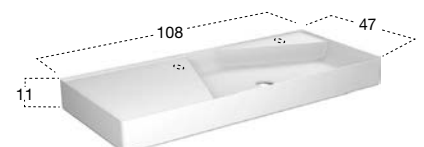

GRAFFIO

_2014

design
Mario
Ferrarini



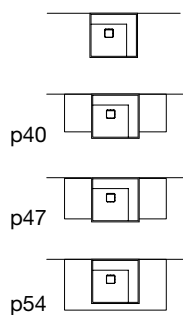

p40

p47

p54

H	P	L	art.
12	50	54	GRAFFIO54

Lavabo rettangolare sopra piano o da parete in Ceramilux con ripiano, completo di piletta con scarico libero e raccordo per sifone.

Rectangular top mount or wall mount Ceramilux sink with shelf, complete with drain pipe fitting and open plug.

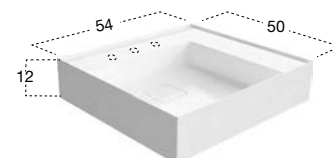



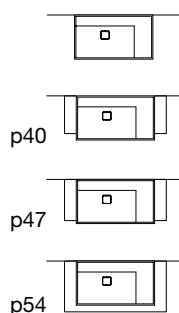

p40

p47

p54

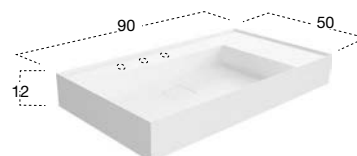

H	P	L	art.
12	50	90	GRAFFIO90

Lavabo rettangolare sopra piano o da parete in Ceramilux con ripiano, completo di piletta con scarico libero e raccordo per sifone.

Rectangular top mount or wall mount Ceramilux sink with shelf, complete with drain pipe fitting and open plug.



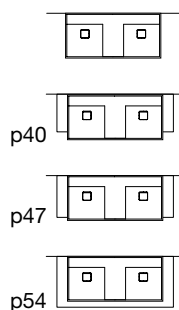

p40

p47

p54

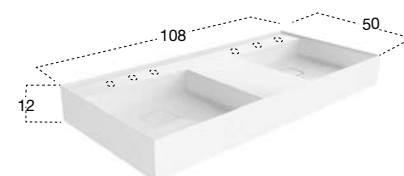

H	P	L	art.
12	50	108	GRAFFIO108

Lavabo rettangolare sopra piano o da parete in Ceramilux con ripiano, completo di piletta con scarico libero e raccordo per sifone.

Rectangular top mount or wall mount Ceramilux sink with shelf, complete with drain pipe fitting and open plug.

GESTO

_2013

design

Nevio

Tellatin

Un tratto semplice, una serie di varianti dimensionali studiate in rapporto alla modularità dei sistemi, una forma conosciuta riattualizzata, rivista, ottimizzata.

È il gesto del lavarsi le mani a dare senso, e anche nome, alla composizione. È la semplicità dell'azione a generare gli elementi di questa collezione di lavabi in Ceramilux. È l'esperienza produttiva di antoniolupi nella lavorazione della materia ad aver favorito la rivisitazione della classica tipologia del lavabo a "canale", riproposto sfruttando le peculiarità del nuovo sistema costruttivo, rendendolo un elemento monolitico che può essere utilizzato sia autonomamente installandolo sospeso, che in abbinamento ai mobili. Il bordo perimetrale è stato ridotto al minimo per dare spazio al bacino e il raccordo armonioso degli angoli interni rende facile la pulizia anche alle estremità. Un oggetto semplice, di uso quotidiano, un segno preciso e rigoroso che rassicura. Gesto è portatore di una normalità che diventa valore all'interno dell'abitare contemporaneo.

A simplified line, a series of models in different sizes studied in relation to the modularity of the systems, a know shape, revisited, revised, optimized.

It is the gesture of washing your hands to make sense and name to the collection. It is the simplicity of the action to generate the elements of this collection of sinks in Ceramilux. It is the productive experience of Antonioplupi in the workmanship of the material to have favored the revival of the classical type of sink to "channel" proposed again by exploiting the features of the new construction making it a monolithic element that can be used alone or on cabinets. The border has been reduced significantly to give room for the basin and allow for easy cleaning. A simple object, for daily use a precise and rigorous sign that assures. Gesto is the bearer of a normality that becomes value in contemporary living.





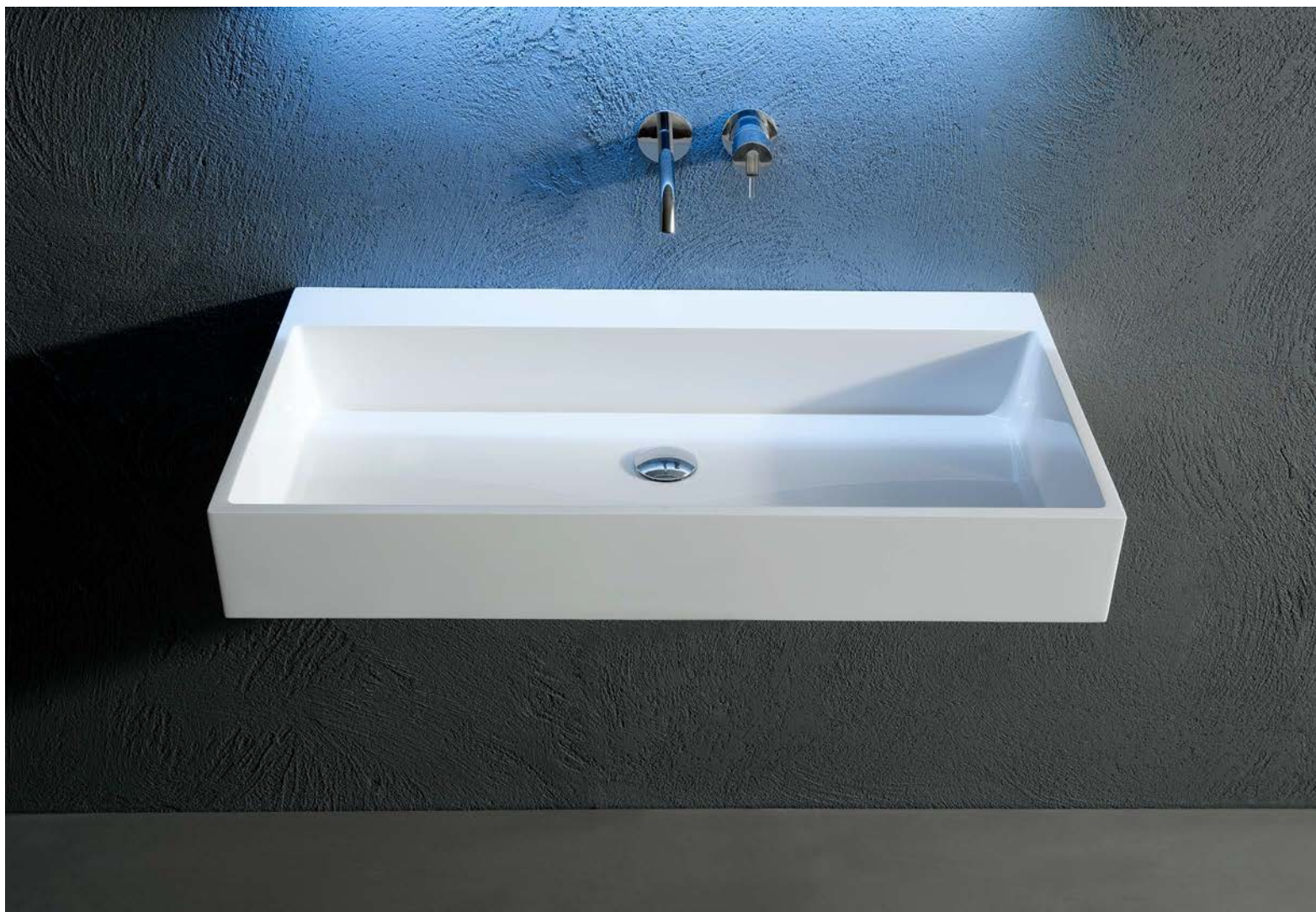

GEST054

GEST063

GEST090

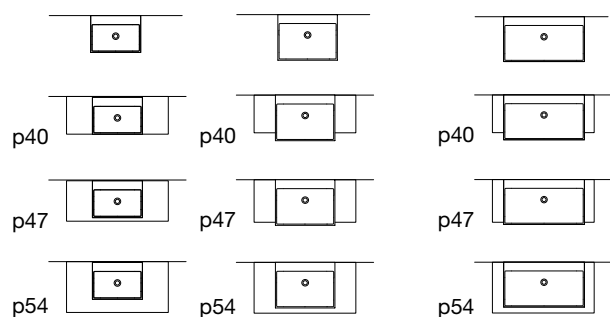

H	P	L	art.
13	40	54	GEST054
13	50	63	GEST063
13	50	90	GEST090

Lavabo rettangolare sopraiano o da parete in Ceramilux lucido o opaco, completo di piletta con scarico libero e raccordo per sifone.

Rectangular top mount or wall mount glossy or matt Ceramilux sink, complete with drain pipe fitting and open plug.





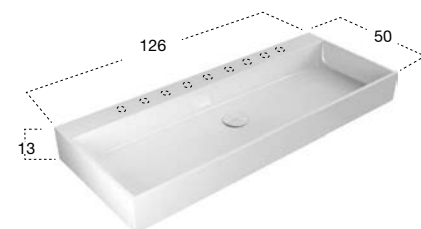
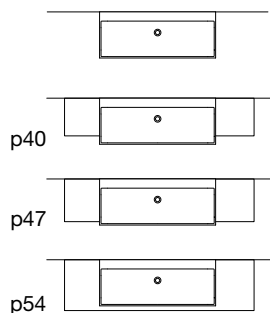

LAVABI
SINKS

H	P	L	art.
13	50	126	GEST0126

Lavabo rettangolare sopra-piano o da parete in Ceramilux lucido o opaco, completo di piletta con scarico libero e raccordo per sifone.

Rectangular top mount or wall mount glossy or matt Ceramilux sink, complete with drain pipe fitting and open plug.



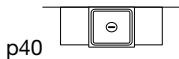

p40

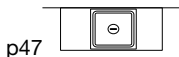

p47

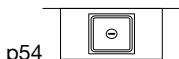

p54

H	P	L	art.
15,5	45	45	BLOKK02

Lavabo quadro sopra piano in Cristalplant, completo di piletta con scarico libero e raccordo per sifone.

Square Cristalplant top mount sink complete with drain pipe fitting and open plug.

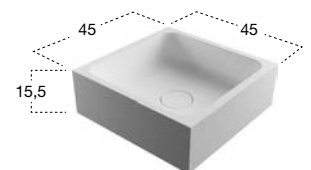



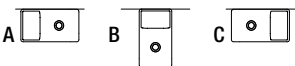

OPTIONAL
Troppopieno
Overflow



LAVABI
SINKS

H	P	L	art.
11	25	45	SIMPLOMANI

Lavabo rettangolare sopra piano o da parete in Flumood, completo di piletta con scarico libero e raccordo per sifone.

Rectangular top mount or wall mount Flumood sink, complete with drain pipe fitting and open plug.

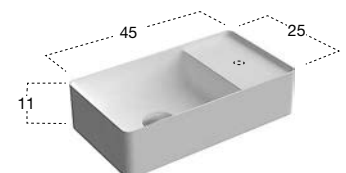



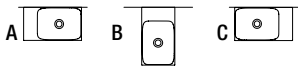

OPTIONAL
Troppieno
Overflow



LAVABI
SINKS

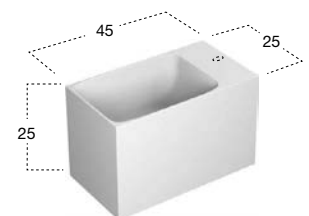

H	P	L	art.
25	25	45	CALCO

Lavabo rettangolare da parete in Flumood finitura texture completo di piletta con scarico libero e raccordo per sifone.

Rectangular wall mount Flumood texture sink, complete with drain pipe fitting and open plug.



SPECCHI COLLAGE
COLLAGE MIRRORS

COLLAGE

2 STRATI / 2 LAYERS

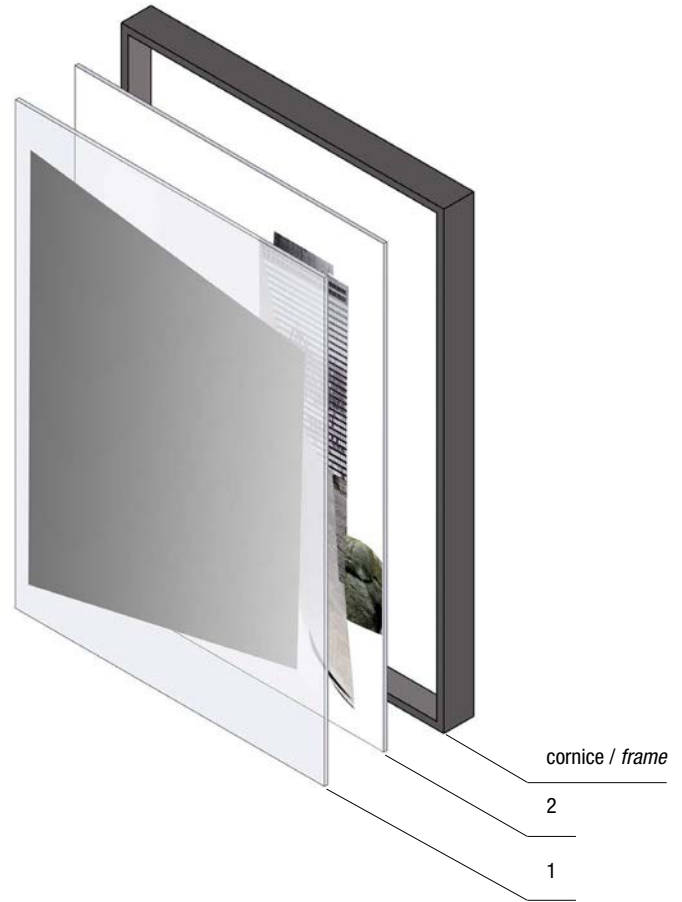
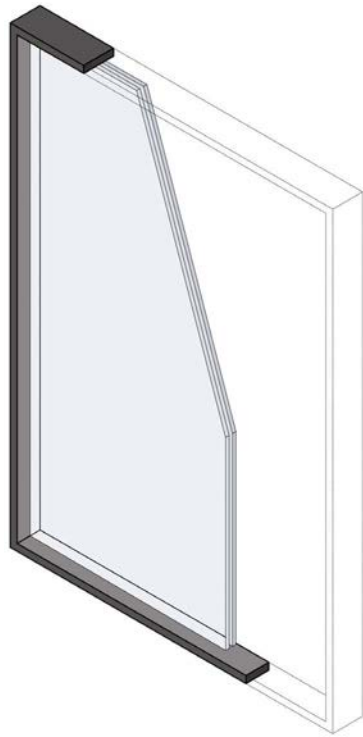

Sono composti da due lastre di vetro inserite in una cornice di alluminio finitura bronzo. La prima lastra è parzialmente argentata a creare la superficie specchiante mentre l'altra sullo sfondo, è stampata con le varie immagini su fondo bianco. La leggera distanza tra i due vetri, lo spessore della cornice è di 4,2 cm, crea un suggestivo effetto di tridimensionalità.

They consist of two layers of glass inserted in a bronze finish aluminum frame. The first layer is partially mirrored while the other in the background is printed with various images on a white background. The slight distance between the two glasses, the thickness of the frame is 4.2 cm, creates a striking three-dimensional effect.

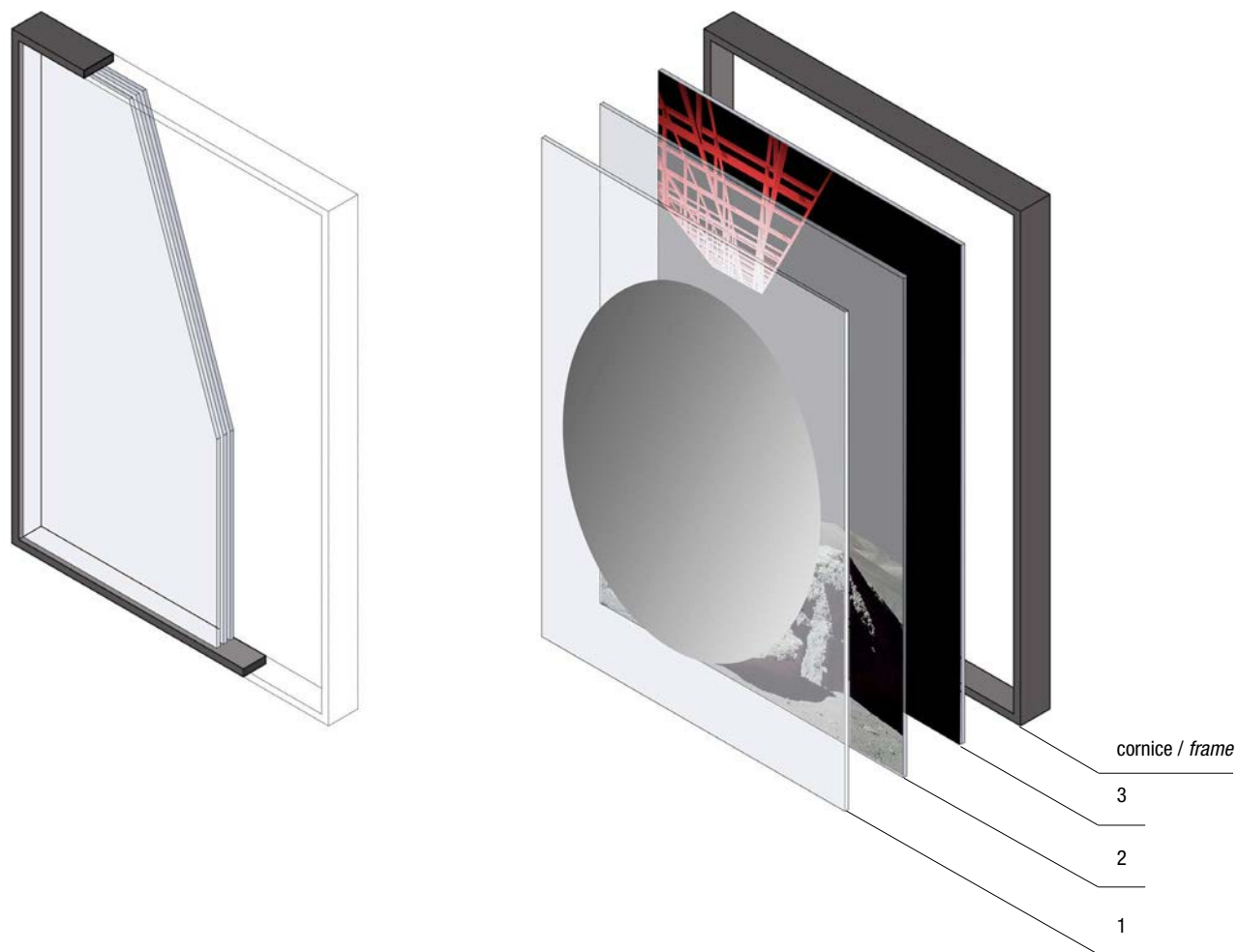

Sono composti da tre lastre di vetro inserite in una cornice di alluminio finitura bronzo. La prima lastra è parzialmente argentata a creare la superficie specchiante, la seconda ospita una stampa parziale su fondo trasparente, mentre la terza, in sequenza, è stampata con una immagine su fondo bianco. La leggera distanza tra i tre vetri, lo spessore della cornice è di 5,4 cm, crea un forte effetto di tridimensionalità.

They consist of three layers of glass inserted in a bronze finish aluminum frame. The first layer is partially mirrored, the second has a partial print on a transparent background, while the third, in sequence, is a printed image on a white background. The slight distance between the three glasses, the thickness of the frame is 5.4 cm, creates a strong three-dimensional effect.





COLLAGE

_2019

design
Luca
Galofaro



COLLAGE













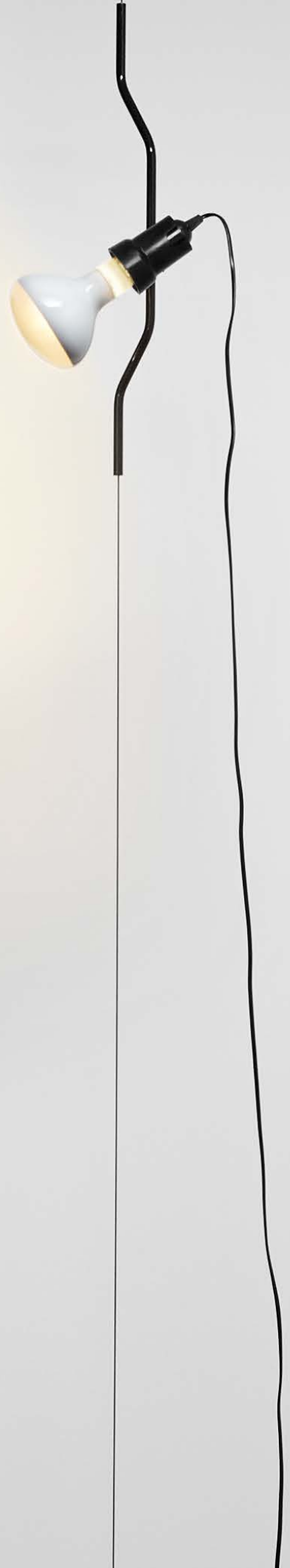









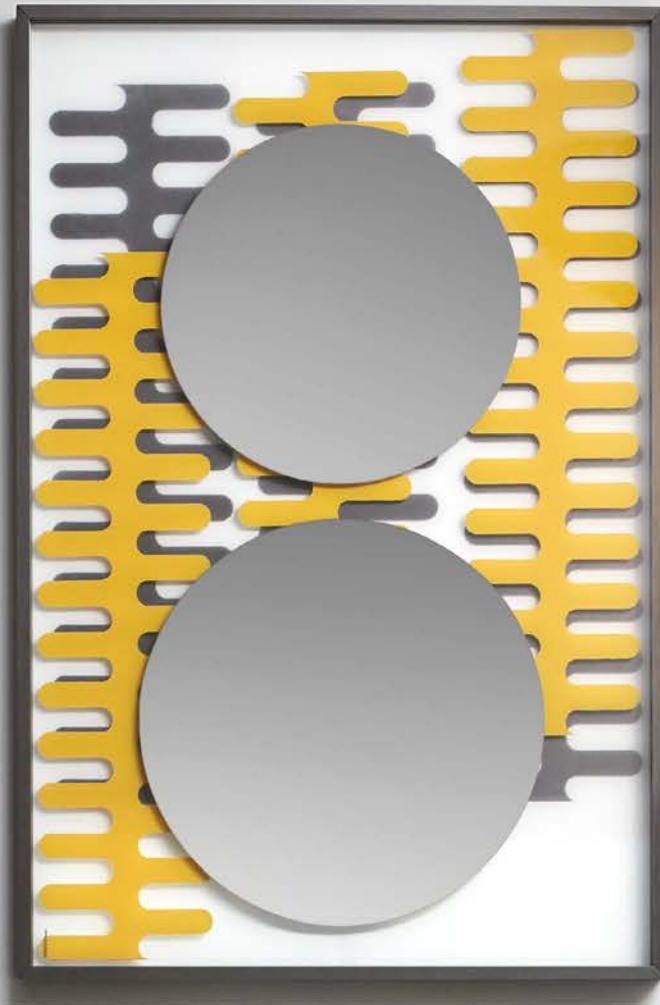











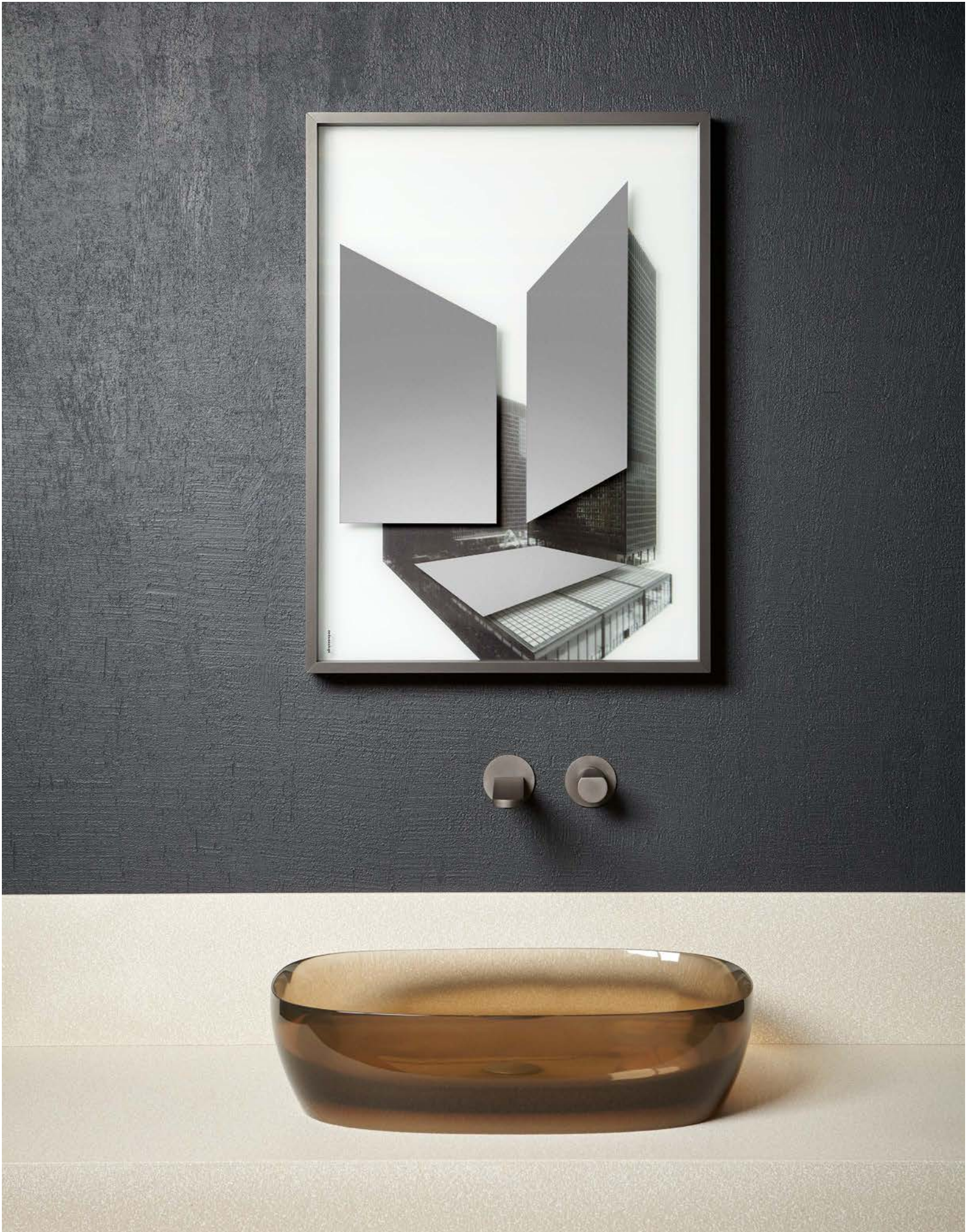













ntoniolupi







COLLAGE

2 STRATI / 2 LAYERS

Specchi a 2 strati, di cui uno stampato e l'altro argentato, con cornice in alluminio finitura bronzo.
 Mirrors with 2 layers, one is printed and one is mirrored, with frame in aluminum bronze finish.

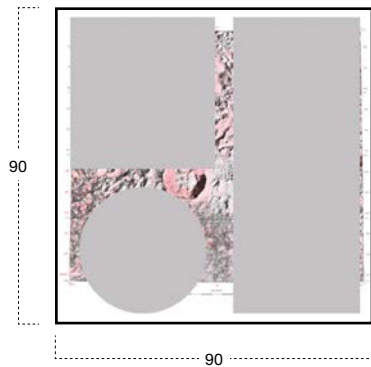

H	L	ART.
90	90	COLLAGE262

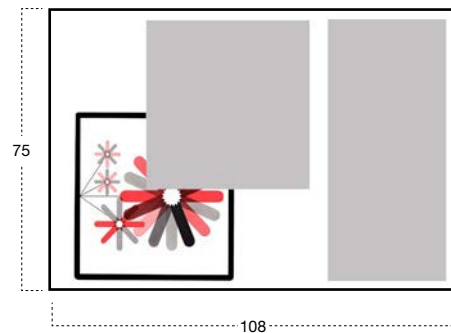

H	L	ART.
75	108	COLLAGE259

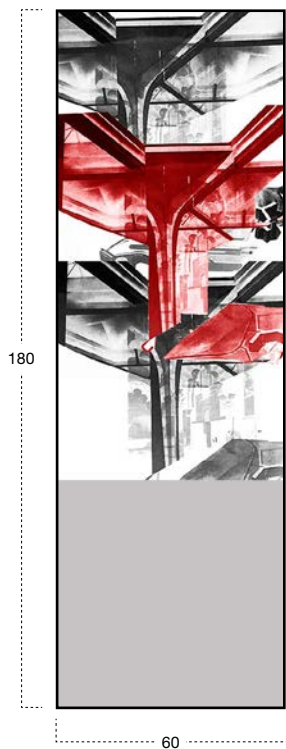

H	L	ART.
180	60	COLLAGE252

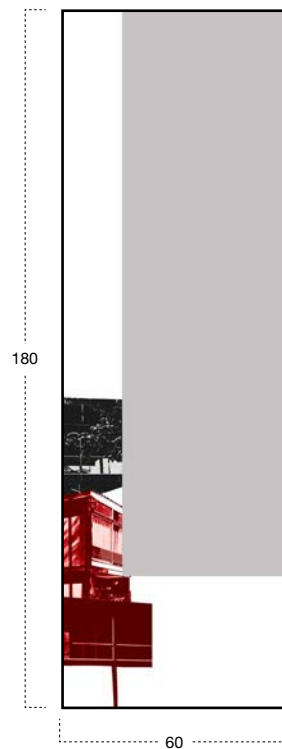

H	L	ART.
180	60	COLLAGE252B

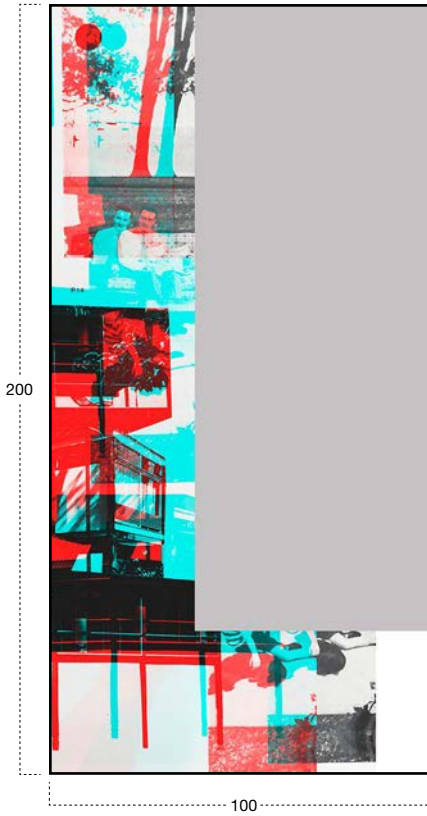

H L ART.
200 100 COLLAGE270

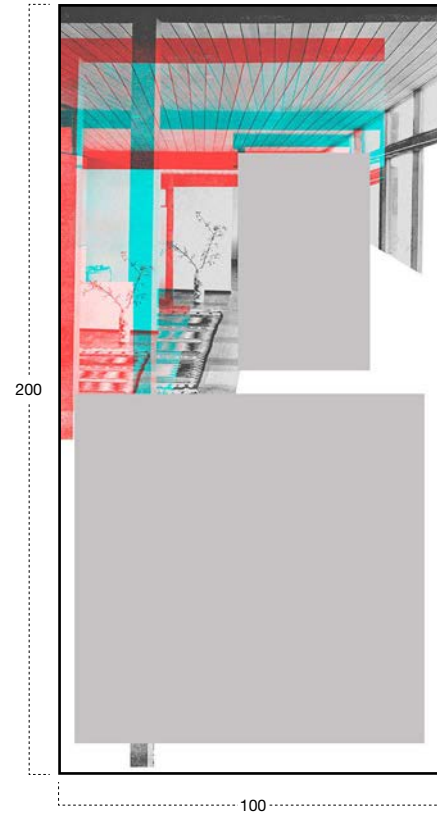

H L ART.
200 100 COLLAGE271

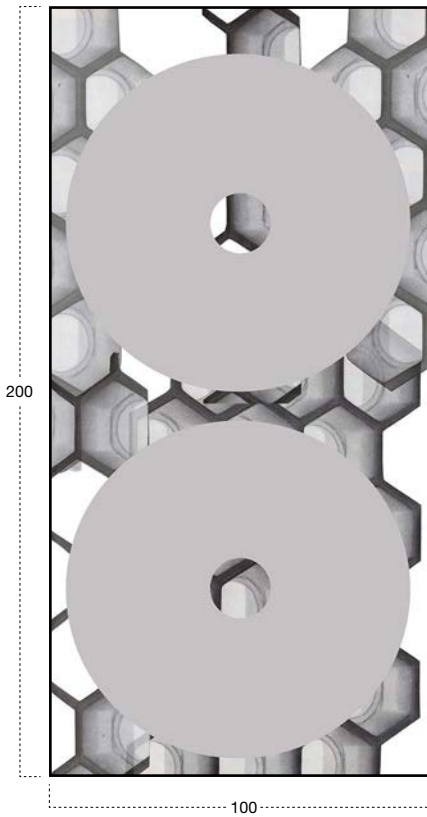

H L ART.
200 100 COLLAGE269

COLLAGE

3 STRATI / 3 LAYERS

Specchi a 3 strati, di cui due stampati e uno argentato, con cornice in alluminio finitura bronzo.
 Mirrors with 3 layers, two are printed and one is mirrored, with frame in aluminum bronze finish.

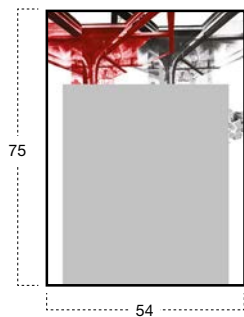

H	L	ART.
75	54	COLLAGE350



H	L	ART.
75	54	COLLAGE353

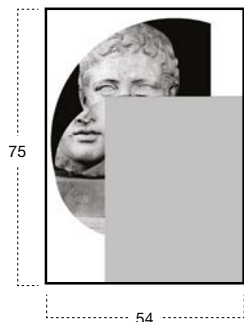

H	L	ART.
75	54	COLLAGE354

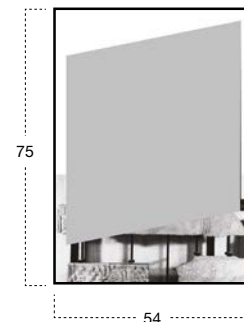

H	L	ART.
75	54	COLLAGE355

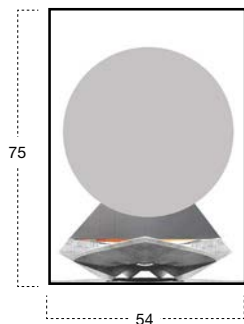

H	L	ART.
75	54	COLLAGE365

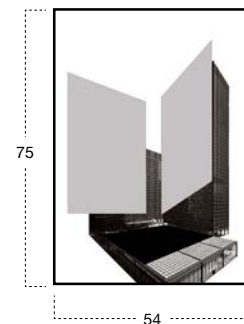

H	L	ART.
75	54	COLLAGE367



H	L	ART.
75	54	COLLAGE368

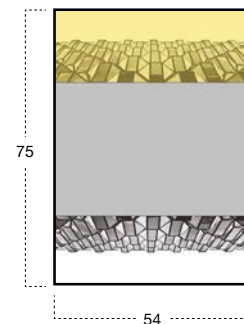

H	L	ART.
75	54	COLLAGE357

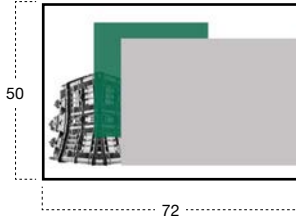

H L ART.
50 72 COLLAGE358

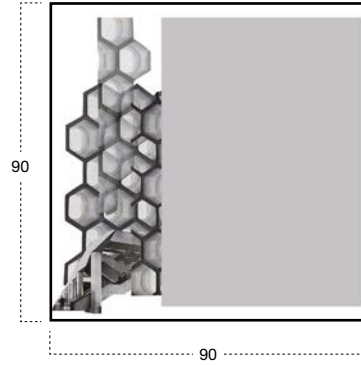

H L ART.
90 90 COLLAGE363

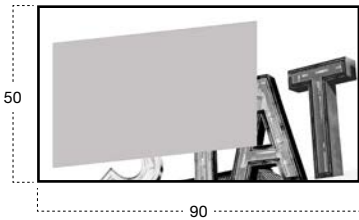

H L ART.
50 90 COLLAGE364

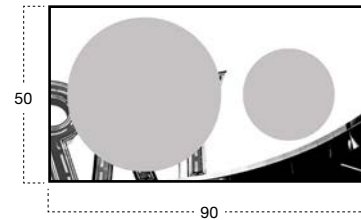

H L ART.
50 90 COLLAGE366

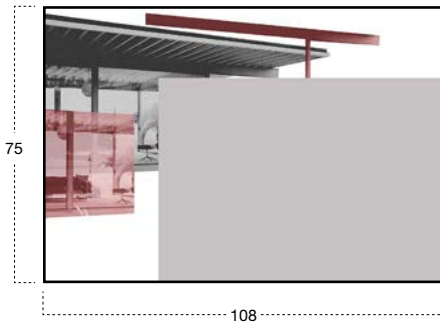

H L ART.
75 108 COLLAGE361

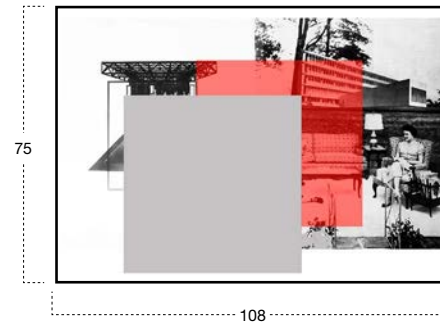

H L ART.
75 108 COLLAGE351

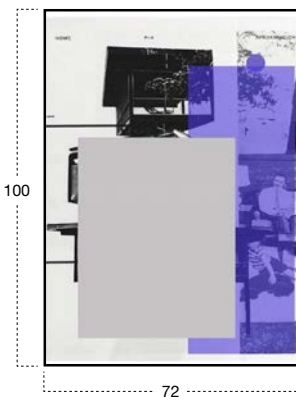

H L ART.
100 72 COLLAGE356

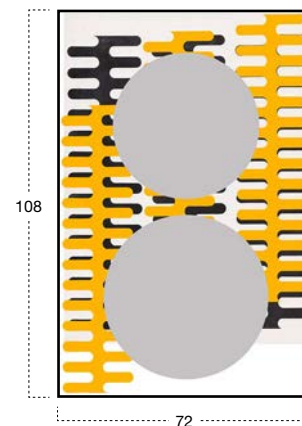

H L ART.
108 72 COLLAGE360

COLLAGE

_2018

design

Luca

Galofaro

Il fil rouge che lega l'arte al design è ormai un segno distintivo del lavoro che antoniolupi sta sviluppando al suo interno. Più che parlare di contaminazione, vorremmo fare riferimento a due fasi esperienziali diverse che si fondono trovando un obiettivo comune: una esperienza univoca del bello che possa entrare a far parte del quotidiano di ognuno di noi. Luca Galofaro, Architetto e Professore, da tempo ha concentrato una parte della sua riflessione sulle relazioni esistenti fra rappresentazione, architettura urbana ed immagine.

Attualmente un'ampia sezione dello showroom Pietra e Fuoco della sede di Stabbia di antoniolupi è dedicata ad una Mostra/Collezione di Disegni di Architettura curata da Galofaro stesso: un passo di crescita aziendale di rilievo.

Adesso Galofaro 'contamina' con la propria visione alcuni prodotti della antoniolupi e stringe ancora di più questa collaborazione nata circa un anno fa con Andrea Lupi: alcuni dei Disegni di Architettura facenti parte della Mostra sono stati infatti selezionati ed applicati agli specchi della linea antoniolupi.

L'idea di trasformare alcuni di questi lavori in oggetti di arredo è stata una conseguenza naturale delle riflessioni condivise fra Galofaro ed Andrea Lupi.

Si è trattato di trasformare un'immagine usata per pensare architettura trasferendola su un oggetto d'uso quotidiano, andando a costruire un ponte tra l'immaginazione che domina l'arte e la vita che è solitamente dominata dalla funzione che l'oggetto ha. La tecnica del collage si basa su una sovrapposizione di frammenti. L'immagine nasce come stratificazione di immagini della memoria. Gli specchi sono realizzati attraverso una stratificazione di lastre in vetro stampate e creano dei collage tridimensionali in cui l'ultimo strato specchiato definisce una relazione con l'osservatore che entra nell'immagine. "Gli specchi Collage, nascono da un progetto più ampio che in quest'ultimo anno ho condiviso con Andrea Lupi. La costruzione della collezione di disegni di architettura Antonio Lupi. Alcuni dei miei collage sono entrati a far parte della collezione. L'idea di trasformare alcuni di questi lavori in oggetti di arredo è stata una conseguenza naturale delle nostre riflessioni condivise. Trasformare un'immagine usata per pensare architettura in un oggetto d'uso, un ponte tra l'immaginazione e vita."

(Luca Galofaro)

The common thread between art and design is now a distinctive sign of antoniolupi's work. More than fusion, we would refer to two different experiences mixed together to achieve a common goal: an univocal experience of beauty that becomes part of our daily life.

Luca Galofaro, Architect and Teacher, has focused his attention on relationships between representation, urban architecture and image.

An area of the antoniolupi showroom, La Pietra e il Fuoco, in Stabbia is currently hosting an Exhibition/Architecture Drawing Collection curated by Galofaro himself: an important step forward in the company's growth strategy.

Now Galofaro 'influences' some of the antoniolupi products with his vision and the collaboration between him and Andrea Lupi is becoming even closer: some Architecture Drawings of the exhibition have been chosen to be used on antoniolupi mirrors. Transforming some of these works in real furniture objects was a natural consequence of the reflection shared by Galofaro and Andrea Lupi.

The idea consists of transferring an image used to think of architecture to an item of everyday life, building a bridge between imagination, which dominates art and life, normally dominated by the function of the object. The collage technique is based on overlapping fragments. The image comes from the stratification of images of memory.

Mirrors are made overlapping printed glass plates, creating tridimensional collages. The last mirrored layer establishes a relationship with the observer, who becomes part of the image itself.

"The Collage mirrors are born from a larger project that I've shared with Andrea Lupi in the past year. The construction of the Antonio Lupi architectural drawings collection. Some of my collages have become part of the collection.

The idea of turning some of these works into furnishing objects was a natural consequence of our shared reflections. Transforming an image used to think about architecture into an object of use, a bridge between imagination and life."

(Luca Galofaro)





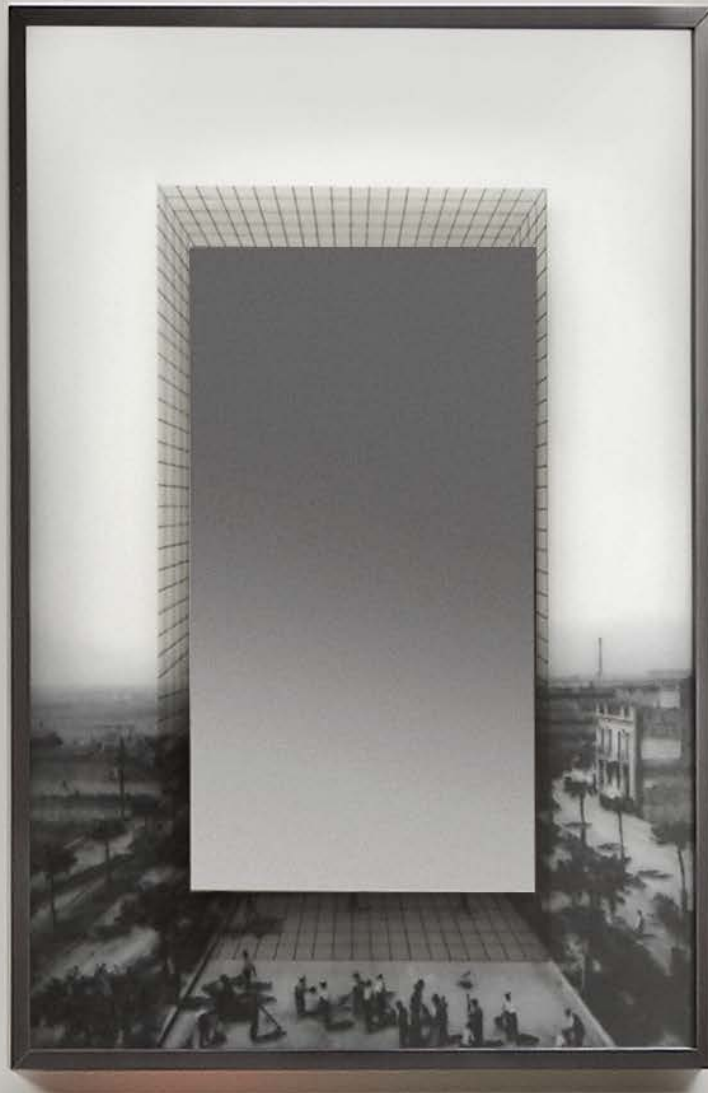





art. COLLAGE222 H 108 cm L 36 cm

art. COLLAGE221 H 108 cm L 36 cm

COLLAGE

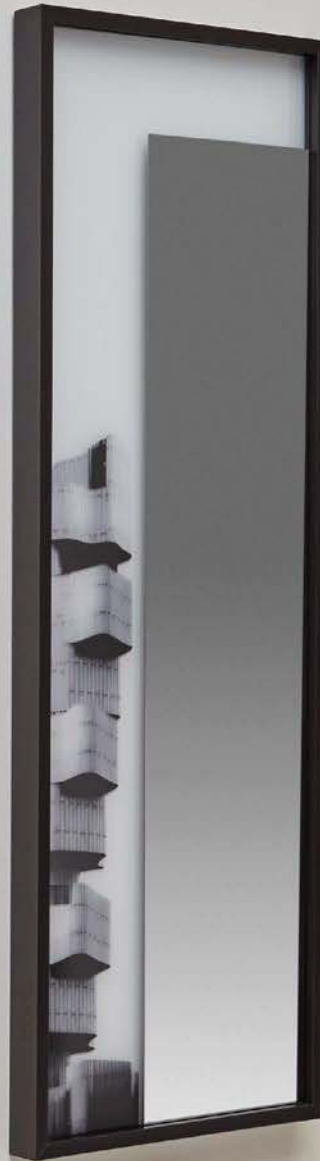

COLLAGE





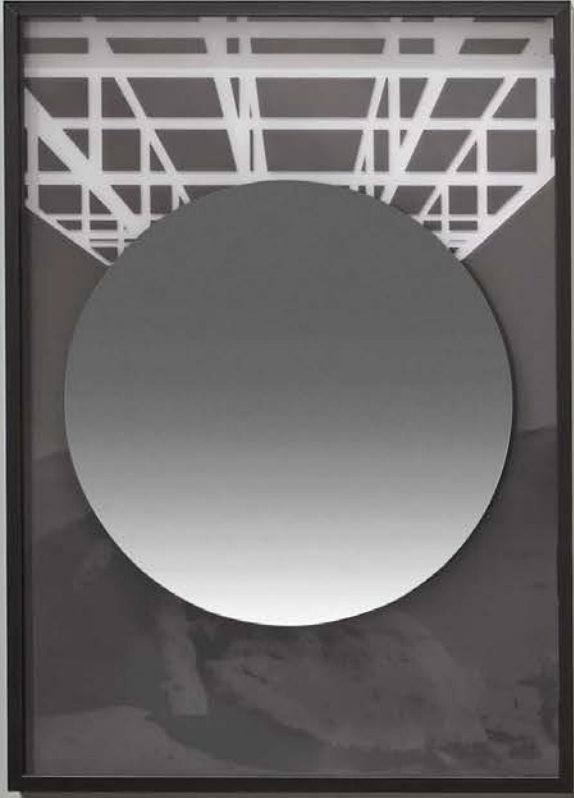



















COLLAGE

2 STRATI / 2 LAYERS

Specchi a 2 strati, di cui uno stampato e l'altro argentato, con cornice in alluminio finitura bronzo.
 Mirrors with 2 layers, one is printed and one is mirrored, with frame in aluminum bronze finish.

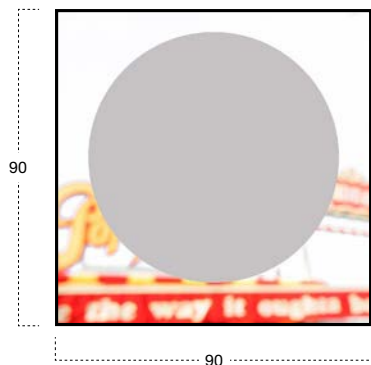

H	L	ART.
90	90	COLLAGE202

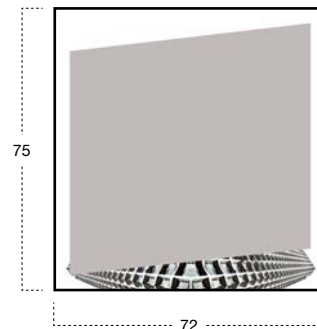

H	L	ART.
75	72	COLLAGE219

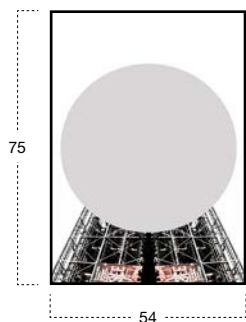

H	L	ART.
75	54	COLLAGE212

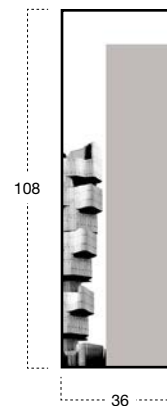

H	L	ART.
108	36	COLLAGE221

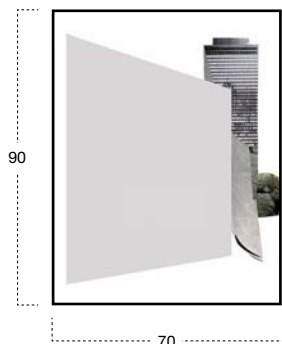

H	L	ART.
90	70	COLLAGE213



H	L	ART.
108	36	COLLAGE222

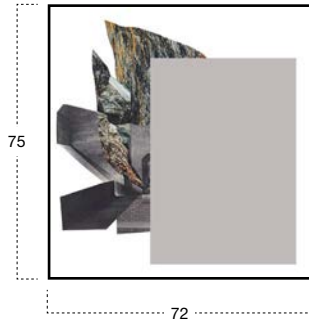

H	L	ART.
75	72	COLLAGE225

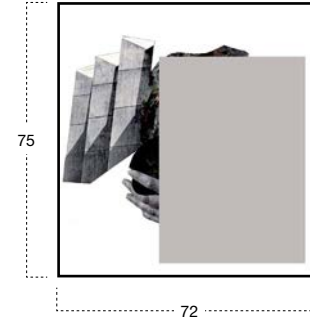

H	L	ART.
75	72	COLLAGE227

3 STRATI / 3 LAYERS

Specchi a 3 strati, di cui due stampati e uno argentato, con cornice in alluminio finitura bronzo.
 Mirrors with 3 layers, two are printed and one is mirrored, with frame in aluminum bronze finish.

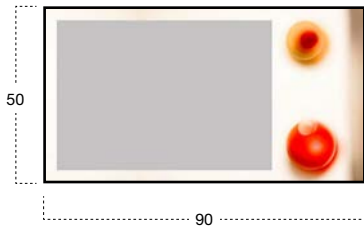

H	L	ART.
50	90	COLLAGE303

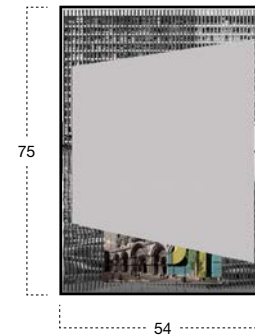

H	L	ART.
75	54	COLLAGE306

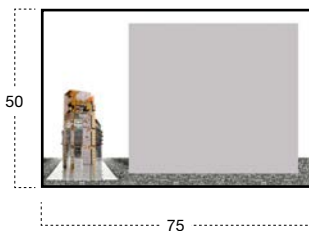

H	L	ART.
50	75	COLLAGE304

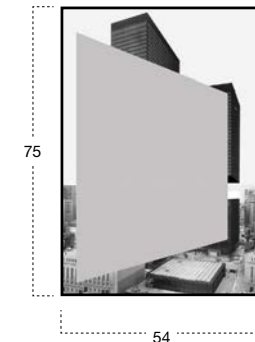

H	L	ART.
75	54	COLLAGE307

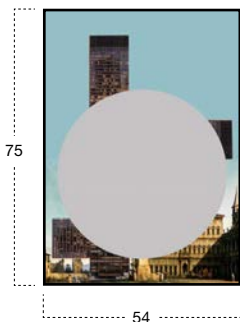

H	L	ART.
75	54	COLLAGE305

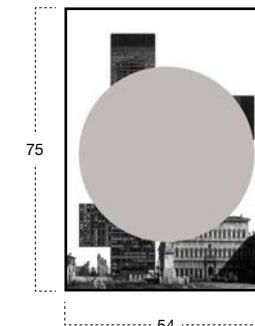

H	L	ART.
75	54	COLLAGE318

COLLAGE

3 STRATI / 3 LAYERS

Specchi a 3 strati, di cui due stampati e uno argentato, con cornice in alluminio finitura bronzo.
Mirrors with 3 layers, two are printed and one is mirrored, with frame in aluminum bronze finish.

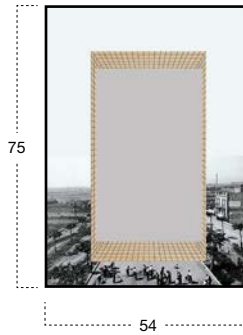

H	L	ART.
75	54	COLLAGE309

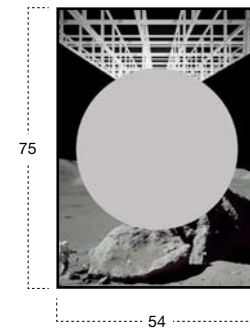

H	L	ART.
75	54	COLLAGE314A

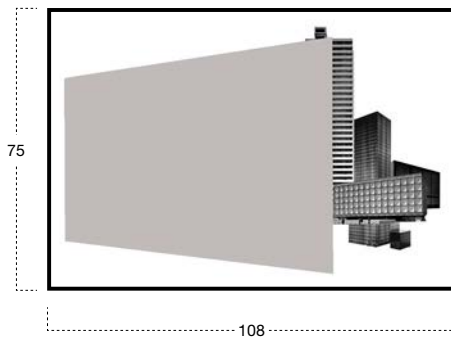

H	L	ART.
75	108	COLLAGE317

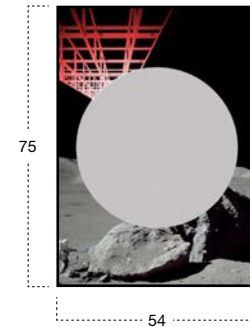

H	L	ART.
75	54	COLLAGE314B

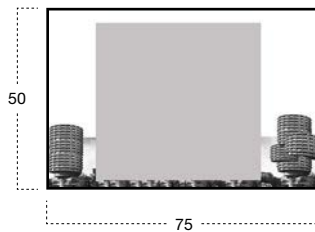

H	L	ART.
50	75	COLLAGE308

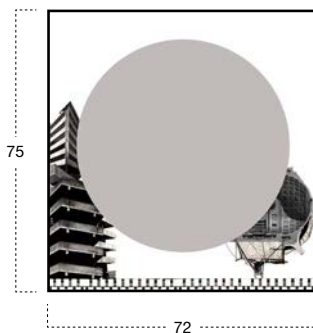

H	L	ART.
75	72	COLLAGE320

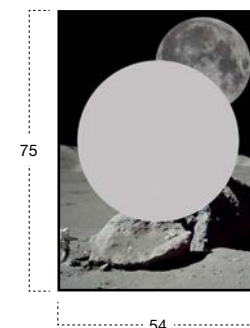

H	L	ART.
75	54	COLLAGE314C





SPECCHI E ILLUMINAZIONE

MIRRORS AND LIGHTING

illuminazione a LED 4000 K. Su richiesta illuminazione
a LED 3000 K senza maggiorazione di prezzo.

*LED lighting 4000 K. Upon request LED lighting 3000 K
available without additional surcharge.*

CIRCUS SUNRISE

_2019

design
AL Studio





Illuminazione a LED 4000 K. Su richiesta illuminazione a LED 3000 K senza maggiorazione di prezzo.

LED lighting 4000 K. Upon request LED lighting 3000 K available without additional surcharge.

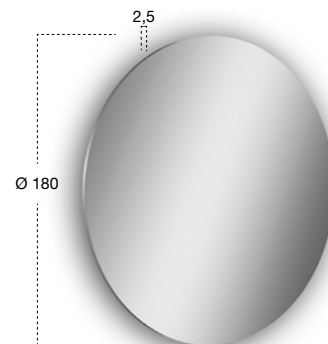

P	Ø	art.	art.
2,5	180	CIRCUS180	CIRCUS180W Con illuminazione a led / With led lighting

Specchio spess. 5 mm a filo lucido con o senza illuminazione a led luce bianca, completo di telaio.

Polished edge mirror 5 mm thick with or without white led lighting, complete with frame.





Illuminazione a LED 4000 K. Su richiesta illuminazione a LED 3000 K senza maggiorazione di prezzo.

LED lighting 4000 K. Upon request LED lighting 3000 K available without additional surcharge.

P	Ø	art.	art.
2,5	72	CIRCUS72	CIRCUS72W Con illuminazione a led / With led lighting
	90	CIRCUS90	CIRCUS90W Con illuminazione a led / With led lighting
	108	CIRCUS108	CIRCUS108W Con illuminazione a led / With led lighting
	120	CIRCUS120	CIRCUS120W Con illuminazione a led / With led lighting
	140	CIRCUS140	CIRCUS140W Con illuminazione a led / With led lighting

Specchio spess. 5 mm a filo lucido con o senza illuminazione a led luce bianca, completo di telaio.

Polished edge mirror 5 mm thick with or without white led lighting, complete with frame.

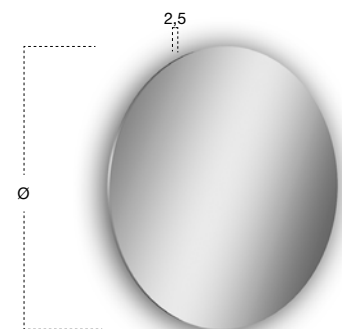

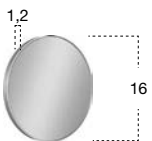
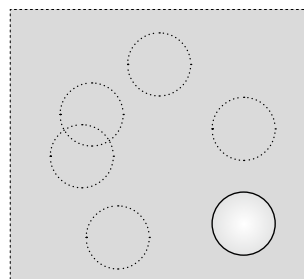
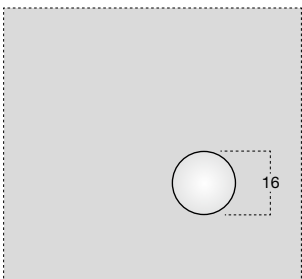

H	art.
50	FOCUS50
75	FOCUS75
90	FOCUS90
100	FOCUS100
110	FOCUS110

Ingranditore 2x completo di piastra magnetica, per specchi Art. ORMA, Art. VARIO, art. VERTICE e art. FILA.

Magnifying mirror 2x complete with magnetic plate for mirrors Art. ORMA, Art. VARIO, art. VERTICE and art. FILA.

Ø	P	art.
16	1,2	FOCUS

Secondo ingranditore 2x.

Second magnifying mirror 2x.

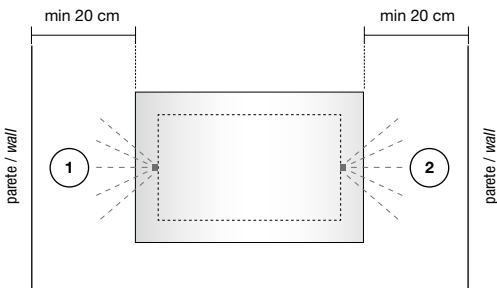

art.
MAGIC

Interruttore di comando accensione a infrarossi per specchiere Art. ORMA e Art. VARIO. I numeri cerchiati indicano le diverse possibilità di posizionamento dell'interruttore.

Infrared lighting control device for mirrors Art. ORMA and Art. VARIO. The circled numbers indicate the different switch positions.

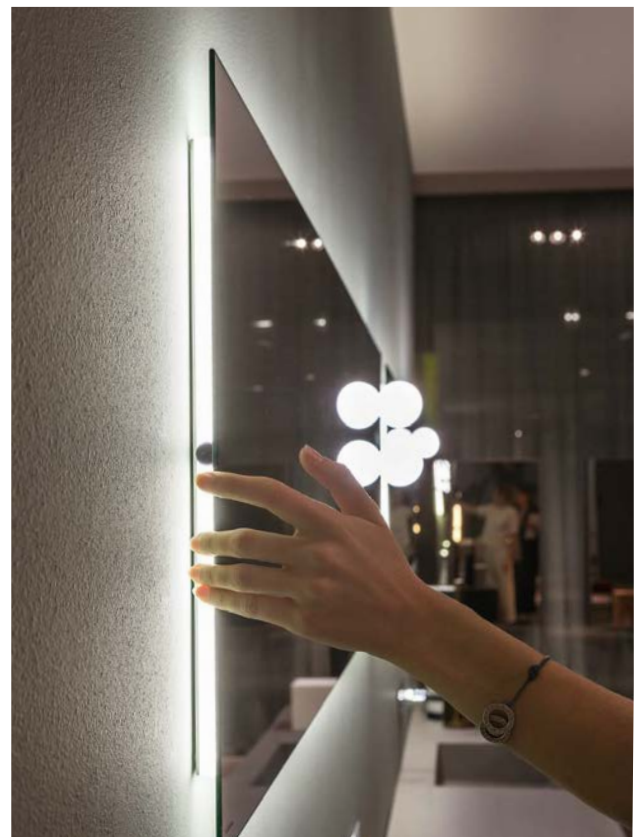

In base alla dimensione dello specchio Art. **ORMA**, Art. **VARIO**, Art. **VERTICE** e Art. **FILA** ordinare n°1 Art. **PIASTRA** corrispondente. Vedi la seguente tabella.

*Based upon the measurement of Art. **ORMA**, Art. **VARIO**, Art. **VERTICE** and Art. **FILA** order n°1 Art. **PIASTRA**. See the following chart.*

	L 54	63	72	81	90	99	108	117	126	135	144	153	162	171	180	189	198	207	216	
H										Art. PIASTRA										
50	---	3	3	3	3	1	1	1	1	1	1	1	1	1	1	1	1	1	1	1
75	3	3	3	3	3	1	1	1	1	1	1	2	2	2	2	2	2	2	2	2
90	3	3	3	3	3	1	1	1	1	1	1	2	2	2	2	2	2	2	2	2
100	1	1	1	1	1	1	1	1	1	1	1	2	2	2	2	2	2	2	2	2
110	1	1	1	2	2	2	2	2	2	2	2	2	2	2	2	2	2	2	2	2

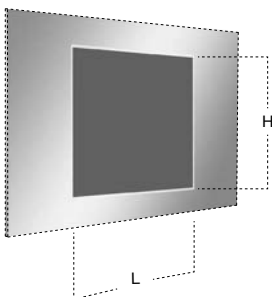

H	L	art.
28	41	24 W 1 PIASTRA1
41	70	60 W 2 PIASTRA2
28	28	16 W 3 PIASTRA3

Sistema riscaldante antiappannamento posizionato al centro per specchiere Art. ORMA, Art. VARIO, Art. VERTICE e Art. FILA.

Anti-fog heating system centered on mirrors Art. ORMA, Art. VARIO, Art. VERTICE and Art. FILA.

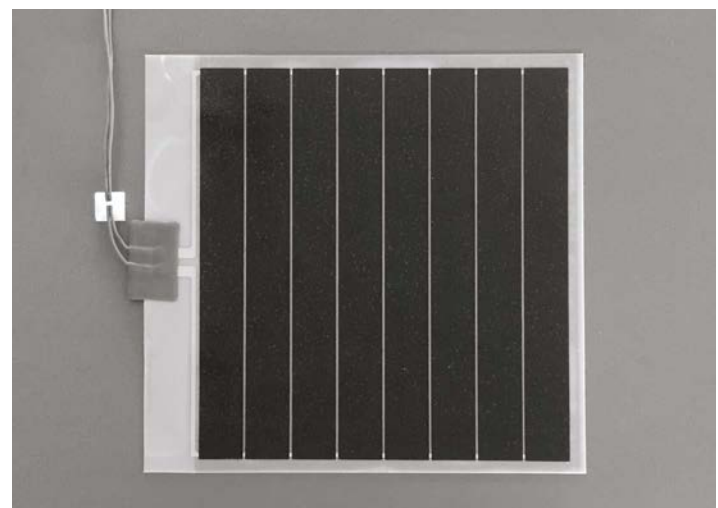





Illuminazione a LED 4000 K. Su richiesta illuminazione a LED 3000 K senza maggiorazione di prezzo.

LED lighting 4000 K. Upon request LED lighting 3000 K available without additional surcharge.

* Misure standard / Standard measures

L 54 - 63 - 72 - 81 - 90 - 99 - 108 - 117 - 126 - 135 - 144 - 153 - 162
171 - 180 - 189 - 198 - 207 - 216

P	L	H	art.
2,5	*	50	ORMA50W
		75	ORMA75W
		90	ORMA90W
		110	ORMA110W

Specchio spess. 4 mm a filo lucido con angoli stondati e illuminazione a led luce bianca, completo di telaio.

Polished edge mirror 4 mm thick with rounded corners and white led lighting, with frame.

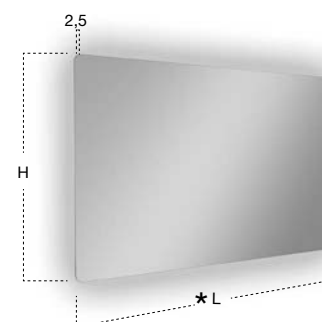





illuminazione a LED 4000 K. Su richiesta illuminazione a LED 3000 K senza maggiorazione di prezzo.

LED lighting 4000 K. Upon request LED lighting 3000 K available without additional surcharge.

* Misure standard / Standard measures

L 54 - 63 - 72 - 81 - 90 - 99 - 108 - 117 - 126 - 135 - 144 - 153 - 162
171 - 180 - 189 - 198 - 207 - 216

P	L	H	art.
2,5	*	50	VARIO50W
		75	VARIO75W
		90	VARIO90W
		100	VARIO100W
		110	VARIO110W

Specchio spess. 4 mm a filo lucido con illuminazione a led, luce bianca completo di telaio.

Polished edge mirror 4 mm thick with white led lighting and frame.

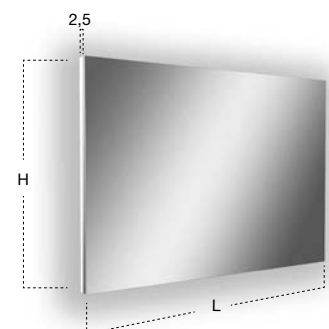

VERTICE

_2016

design
AL Studio

Rimanda all'immagine di un quadro, per via di una fascia perimetrale sabbiata di 3 cm con illuminazione a led che racchiude la superficie specchiante. Vertice è la specchiera con vetro argentato dello spessore di 4 mm sostenuta da un telaio di alluminio nero che grazie a una preziosa cornice luminosa mette in scena il racconto quotidiano dell'ambiente bagno, inquadrando protagonisti e colori.

It reminds to a painting thanks to a 3 cm perimetral sandblasted frame equipped with led-lighting. Vertice is a 4 mm thick mirror sustained by a black aluminum structure and a precious bright frame reflecting everyday life in bath.





illuminazione a LED 4000 K. Su richiesta illuminazione a LED 3000 K senza maggiorazione di prezzo.

LED lighting 4000 K. Upon request LED lighting 3000 K available without additional surcharge.

P	L	H	art.
2,5	da / from 72 a / to 216	75	VERTICE75W
		90	VERTICE90W

Specchio spess. 4 mm a filo lucido con illuminazione a led luce bianca, completo di telaio nero.

Polished edge mirror 4 mm thick with white led lighting, complete with black frame.

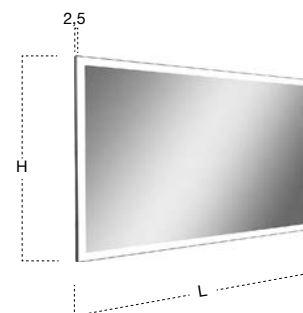

FILA

_2016

design
AL Studio

Una doppia cornice, una specchiante e una luminosa, a evidenziare il perimetro della superficie, a sottolineare l'importanza delle immagini che vi si riflettono. File è una specchiera con vetro spessore 4 mm e fascia perimetrale sabbiata di 1,5 cm con illuminazione a led. È sostenuta da un telaio portante in alluminio nero che conferisce eleganza all'insieme.

A double frame, a reflecting one and a bright one, enhancing the surface perimeter. File is a 4 mm thick mirror with a 1,5 cm sandblasted perimetral frame equipped with led-lighting. It has a black aluminum structure that lends elegance to the context.





illuminazione a LED 4000 K. Su richiesta illuminazione a LED 3000 K senza maggiorazione di prezzo.

LED lighting 4000 K. Upon request LED lighting 3000 K available without additional surcharge.

P	L	H	art.
2,5	da / from 72 a / to 216	75	FILA75W
		90	FILA90W

Specchio spess. 4 mm a filo lucido con illuminazione a led luce bianca, completo di telaio nero.

Polished edge mirror 4 mm thick with white led lighting, complete with black frame.

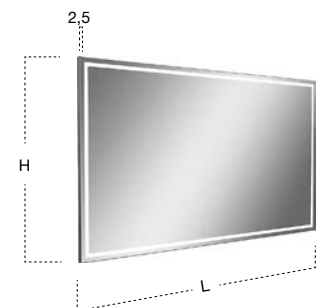

APICE

_2014

design
AL Studio



Essenziale e minimale, Apice è la specchiera con vetro argentato dello spessore 4 mm priva di bordo, disponibile con o senza illuminazione a led. L'immagine nitida e assoluta viene impreziosita da un inserto argentato bronzo o fumè che divide in due parti la superficie conferendo dinamismo all'insieme. Un segno che rompe gli equilibri statici della composizione e ne scalfisce la perfezione geometrica, aggiungendo valore alla forma.

Essential and minimal, Apice is a 4 mm thick mirror without edges, available with or without led-lighting. The crisp image is embellished by a bronze or fume mirrored section that divides into two parts the surface conferring dynamism to the context. A sign that breaks the static equilibriums of the composition, adding value to the shape.



illuminazione a LED 4000 K. Su richiesta illuminazione a LED 3000 K senza maggiorazione di prezzo.

LED lighting 4000 K. Upon request LED lighting 3000 K available without additional surcharge.

P	L	H	art.	art.
2,5	da / from 90 a / to 216	50	APICE50	APICE50W Con illuminazione a led / With led lighting

Specchio spess. 4 mm a filo lucido con o senza illuminazione a led luce bianca e inserto argentato fumé o bronzo, completo di telaio nero.

Polished edge mirror 4 mm thick with or without white led lighting and fumé or bronze silvered insert, complete with black frame.

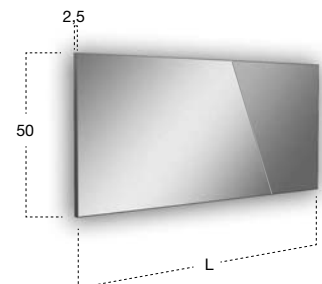

LUCENTE

_2017

design
AL Studio

illuminazione a led diretta

direct led lighting





illuminazione a led indiretta

indirect led lighting

Compatibile solo con specchiere NEUTRO e NEUTROLED. Per applicazione su specchi NEUTROLED, occorre inserirla ad una distanza minima dal bordo superiore di 9 cm.
Non compatibile con specchiere NEUTROLED H 50 cm.

*Compatible only with NEUTRO and NEUTROLED mirrors. For an application on NEUTROLED mirrors it must be installed at a minimum distance from the upper border of 9 cm.
Not compatible with NEUTROLED mirrors H 50 cm.*





Lampada in alluminio verniciato nero con illuminazione a led diretta e indiretta, cover in vetro argentato
 N.B. Per applicazione su specchi NEUTROLED, occorre inserirla ad una distanza minima dal bordo superiore di 9 cm. Non compatibile con specchiere NEUTROLED H 50 cm.

*Black lacquered aluminum lamp with direct and indirect led-lighting, cover in silvered glass
 P.S. For an application on NEUTROLED mirrors it must be installed at a minimum distance from the upper border of 9 cm. Not compatible with NEUTROLED mirrors H 50 cm.*

Illuminazione a LED 4000 K. Su richiesta illuminazione a LED 3000 K senza maggiorazione di prezzo.

LED lighting 4000 K. Upon request LED lighting 3000 K available without additional surcharge.

Per mercato USA e Canada
 For US and Canadian markets

P	H	* L	art.	art.	
4,5	9	45	LUCENTE45	LUCENTES45	12,96 W
		54	LUCENTE54	LUCENTES54	15,55 W
		63	LUCENTE63	LUCENTES63	18,14 W
		72	LUCENTE72	LUCENTES72	20,75 W
		81	LUCENTE81	LUCENTES81	23,35 W
		90	LUCENTE90	LUCENTES90	25,95 W
		99	LUCENTE99	LUCENTES99	28,54 W
		108	LUCENTE108	LUCENTES108	31,14 W
		117	LUCENTE117	LUCENTES117	33,73 W
		126	LUCENTE126	LUCENTES126	36,32 W
		135	LUCENTE135	LUCENTES135	38,92 W
		144	LUCENTE144	LUCENTES144	41,51 W
		153	LUCENTE153	LUCENTES153	44,10 W
		162	LUCENTE162	LUCENTES162	46,70 W
		171	LUCENTE171	LUCENTES171	49,29 W
		180	LUCENTE180	LUCENTES180	51,89 W
		189	LUCENTE189	LUCENTES189	54,48 W
		198	LUCENTE198	LUCENTES198	57,08 W
		207	LUCENTE207	LUCENTES207	59,67 W
		216	LUCENTE216	LUCENTES216	62,27 W

* Misure standard / Standard measures

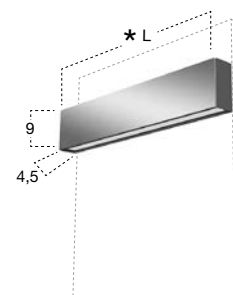





Illuminazione a LED 4000 K. Su richiesta illuminazione a LED 3000 K senza maggiorazione di prezzo.

LED lighting 4000 K. Upon request LED lighting 3000 K available without additional surcharge.

Ø	L	ART.
90	112,5	CIRCUS190W
108	135	CIRCUS1108W

Specchio spess. 5 mm a filo lucido con illuminazione a led luce bianca, completo di telaio e lampada LUCENTE versione dx o sx.

Polished edge mirror 5 mm thick with white led lighting, complete with frame and lamp art. LUCENTE, right or left hand version.

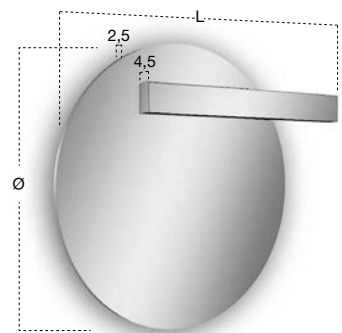

Versione dx

Right version

459

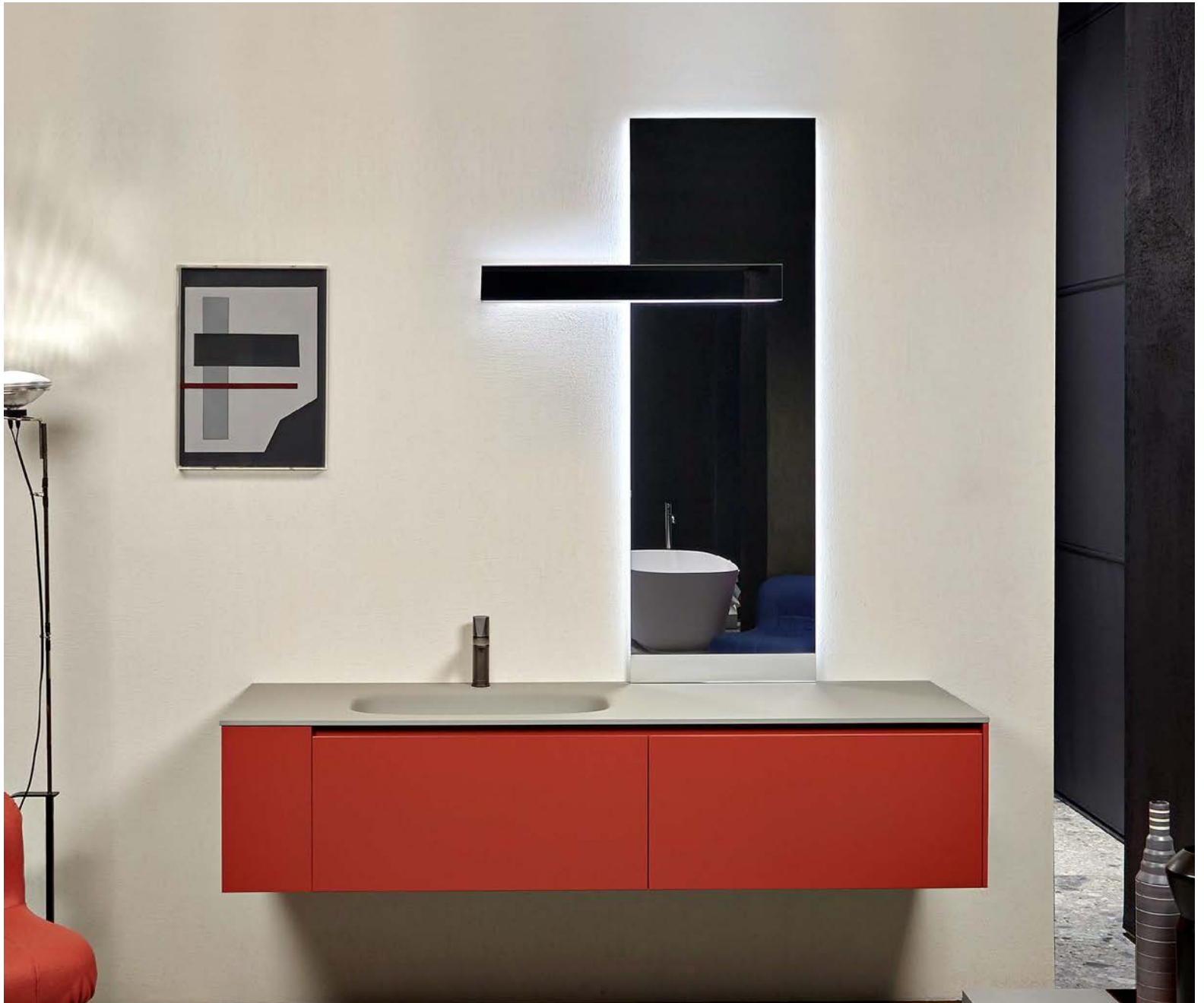

illuminazione a LED 4000 K. Su richiesta illuminazione a LED 3000 K senza maggiorazione di prezzo.

LED lighting 4000 K. Upon request LED lighting 3000 K available without additional surcharge.

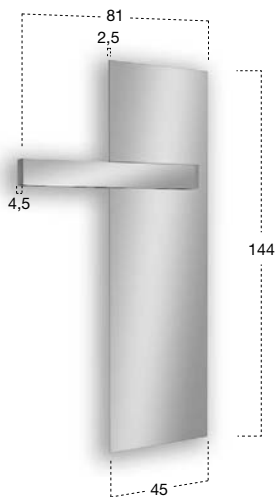

Versione sx

Left version

460

H	L	ART.
144	81	NEOLUCE1

Specchio spess. 5 mm a filo lucido con illuminazione a led luce bianca, completo di telaio e lampada LUCENTE versione dx o sx.

Polished edge mirror 5 mm thick with white led lighting complete with frame and lamp LUCENTE, right or left hand version.



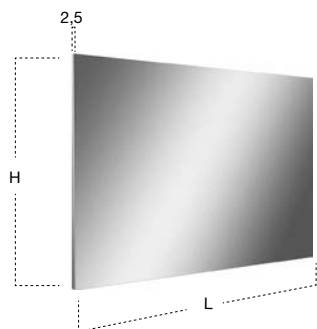

P	L	H	art.
2,5	da / from 54 a / to 216	50	NEUTRO50
		75	NEUTRO75
		90	NEUTRO90
		100	NEUTRO100
		110	NEUTRO110

Specchio spess. 5 mm a filo lucido orizzontale o verticale, completo di telaio nero.

Polished edge mirror 5 mm thick mounted horizontally or vertically, complete with black frame.



Illuminazione a LED 4000 K. Su richiesta illuminazione a LED 3000 K senza maggiorazione di prezzo.

LED lighting 4000 K. Upon request LED lighting 3000 K available without additional surcharge.

P	L	H	art.
2,5	da / from 54 a / to 216	50	NEUTROLED50W
		75	NEUTROLED75W
		90	NEUTROLED90W
		100	NEUTROLED100W
		110	NEUTROLED110W
		125	NEUTROLED125W
		142	NEUTROLED142W

Specchio spess. 5 mm a filo lucido orizzontale o verticale con illuminazione a led luce bianca, completo di telaio.

Polished edge mirror 5 mm thick mounted horizontally or vertically with white led lighting complete with frame.

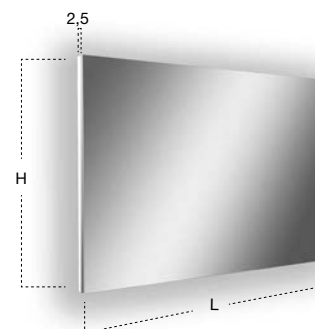





illuminazione a LED 4000 K. Su richiesta illuminazione a LED 3000 K senza maggiorazione di prezzo.

LED lighting 4000 K. Upon request LED lighting 3000 K available without additional surcharge.

P	L	H	art.
2,5	45	144	NEUTRO1144W45
	45	180	NEUTRO1180W45

Specchio spess. 5 mm a filo lucido con illuminazione a led luce bianca, completo di telaio.

Polished edge mirror 5 mm thick with white led lighting, complete with frame.

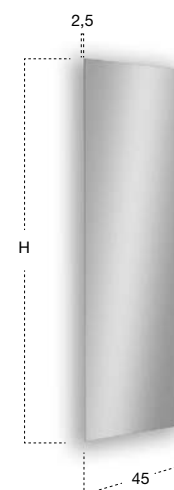



Illuminazione a LED 4000 K. Su richiesta illuminazione a LED 3000 K senza maggiorazione di prezzo.

LED lighting 4000 K. Upon request LED lighting 3000 K available without additional surcharge.

P	L	H	art.
2,5	54	210	NEUTRO210W54
	72	210	NEUTRO210W72
	90	210	NEUTRO210W90

Specchio spess. 5 mm a filo lucido con illuminazione a led luce bianca, completo di telaio.

Polished edge mirror 5 mm thick with white led lighting, complete with frame.

P	L	H	art.
2,5	54	210	NTKIT210W54
	72	210	NTKIT210W72
	90	210	NTKIT210W90

Specchio spess. 5 mm a filo lucido con illuminazione a led luce bianca, completo di telaio predisposto per corpo ad incasso Art. SP201INSA, Art. SP201INLU.

Polished edge mirror 5 mm thick complete with frame and white led lighting prepared for concealed valves Art. SP201INSA, Art. SP201INLU.

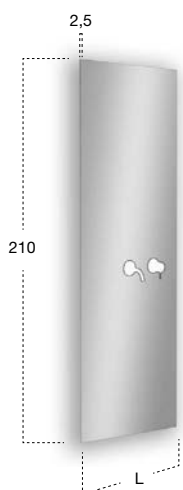



Illuminazione a LED 4000 K. Su richiesta illuminazione a LED 3000 K senza maggiorazione di prezzo.

LED lighting 4000 K. Upon request LED lighting 3000 K available without additional surcharge.

P	L	H	art.
2,5	da / from 54 a / to 216	50	NTKIT50W
		75	NTKIT75W
		90	NTKIT90W
		100	NTKIT100W
		110	NTKIT110W
		125	NTKIT125W
		142	NTKIT142W

Specchio spess. 5 mm a filo lucido orizzontale o verticale con illuminazione a led luce bianca, completo di telaio predisposto per corpo ad incasso Art. SP201INSA, Art. SP201INLU e/o porta salviette RETTA.

Polished edge mirror 5 mm thick mounted horizontally or vertically complete with frame and white led lighting prepared for concealed valves Art. SP201INSA, Art. SP201INLU and/or towel rail Art. RETTA.

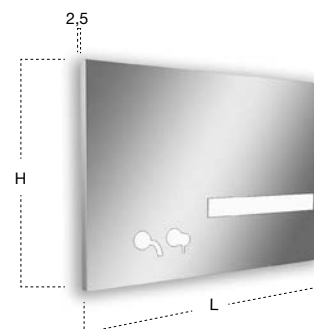

NEUTROLED (A) + NEUTROKIT (B)

Esempi di possibili composizioni con specchiere
art. NEUTROLED (A) e art. NEUTROKIT (B).

*Examples of possible compositions with mirrors
art. NEUTROLED (A) and art. NEUTROKIT (B).*









Illuminazione a LED 4000 K. Su richiesta illuminazione a LED 3000 K senza maggiorazione di prezzo.

LED lighting 4000 K. Upon request LED lighting 3000 K available without additional surcharge.

P	L	H	art.
4	da / from 72 a / to 216	50	FLASH50W
		75	FLASH75W
		90	FLASH90W
		100	FLASH100W

 Per mercato USA e Canada
For US and Canadian markets

P	L	H	art.
4	da / from 72 a / to 216	50	FLASH050S
		75	FLASH075S
		90	FLASH090S
		100	FLASH100W

Specchio spess. 5 mm a filo lucido con illuminazione a led luce bianca, completo di telaio in acciaio lucido AISI 304.

N.B. Su richiesta è possibile avere illuminazione a led bianca e blu.

Polished edge mirror 5 mm thick with white led lighting, complete with polished steel frame AISI 304.
P.S. Upon request it is possible to have white and blue led lighting.

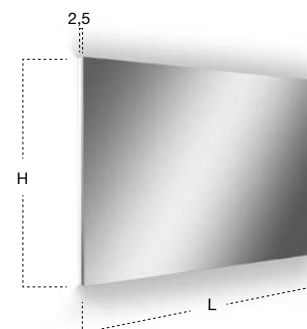



illuminazione a LED 4000 K. Su richiesta illuminazione a LED 3000 K senza maggiorazione di prezzo.

LED lighting 4000 K. Upon request LED lighting 3000 K available without additional surcharge.

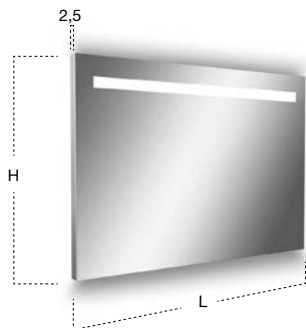

P	L	H	art.
4	da / from 72 a / to 216	50	SPIO650W
		75	SPIO675W
 Per mercato USA e Canada For US and Canadian markets			
P	L	H	art.
4	da / from 72 a / to 216	50	LAMP0050S
		75	LAMP0075S

Specchio spess. 5 mm a filo lucido con illuminazione a led luce bianca, completo di telaio in acciaio lucido AISI 304.

N.B. Su richiesta è possibile avere illuminazione a led bianca e blu.

Polished edge mirror 5 mm thick with white led lighting, complete with polished steel frame AISI 304.
P.S. Upon request it is possible to have white and blue led lighting.



Illuminazione a LED 4000 K. Su richiesta illuminazione a LED 3000 K senza maggiorazione di prezzo.

LED lighting 4000 K. Upon request LED lighting 3000 K available without additional surcharge.

P	L	H	art.
4	da / from 72 a / to 216	50	SPIO150W
		75	SPIO175W
 Per mercato USA e Canada For US and Canadian markets			
P	L	H	art.
4	da / from 72 a / to 216	50	SPIO1050S
		75	SPIO1075S

Specchio spess. 5 mm a filo lucido con illuminazione a led luce bianca, completo di telaio in acciaio lucido AISI 304.

N.B. Su richiesta è possibile avere illuminazione a led bianca e blu.

Polished edge mirror 5 mm thick with white led lighting, complete with polished steel frame AISI 304.
P.S. Upon request it is possible to have white and blue led lighting.

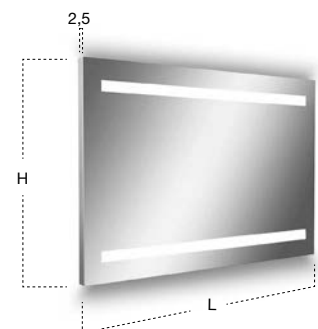



illuminazione a LED 4000 K. Su richiesta illuminazione a LED 3000 K senza maggiorazione di prezzo.

LED lighting 4000 K. Upon request LED lighting 3000 K available without additional surcharge.

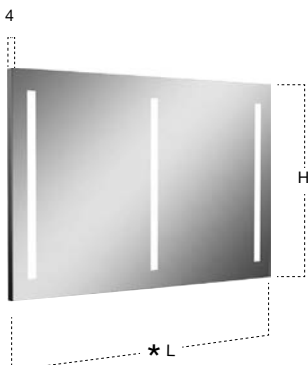

* Misure standard / Standard measures

L 90 - 99 - 108 - 117 - 126 - 135 - 144 - 153 - 162
171 - 180 - 189 - 198 - 207 - 216

P	L	H	art.
4	*	50	SPIO250W
		75	SPIO275W



P	L	H	art.
4	*	50	SPIO2050W
		75	SPIO2075W

Specchio spess. 5 mm a filo lucido con illuminazione a led luce bianca completo di telaio in acciaio lucido AISI 304.

Polished edge mirror 5 mm thick with white led lighting complete with polished stainless steel frame AISI 304.



illuminazione a LED 4000 K. Su richiesta illuminazione a LED 3000 K senza maggiorazione di prezzo.

LED lighting 4000 K. Upon request LED lighting 3000 K available without additional surcharge.

Versione sx / Left version

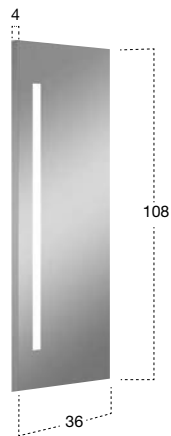

illuminazione a LED 4000 K. Su richiesta illuminazione a LED 3000 K senza maggiorazione di prezzo.

LED lighting 4000 K. Upon request LED lighting 3000 K available without additional surcharge.

Versione dx / Right version

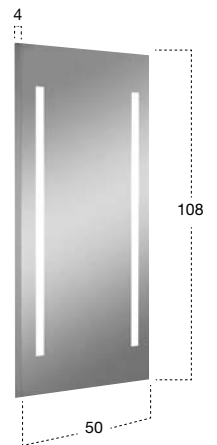

P	L	H	art.
4	36	108	SPIO4W

 Per mercato USA e Canada
For US and Canadian markets

P	L	H	art.
4	36	108	SPIO4S

Specchio spess. 5 mm dx o sx a filo lucido con illuminazione a led luce bianca completo di telaio in acciaio lucido AISI 304.

Polished edge mirror 5 mm thick, right or left, with white led lighting complete with polished stainless steel frame AISI 304.

P	L	H	art.
4	50	108	SPIO5W

 Per mercato USA e Canada
For US and Canadian markets

P	L	H	art.
4	50	108	SPIO5S

Specchio spess. 5 mm a filo lucido con illuminazione a led luce bianca completo di telaio in acciaio lucido AISI 304.

Polished edge mirror 5 mm thick with white led lighting complete with polished stainless steel frame AISI 304.



illuminazione a LED 4000 K. Su richiesta illuminazione a LED 3000 K senza maggiorazione di prezzo.

LED lighting 4000 K. Upon request LED lighting 3000 K available without additional surcharge.

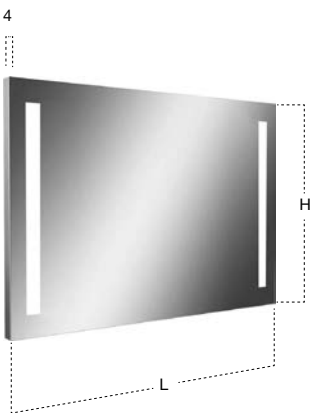

* Misure standard / Standard measures

L 72 - 81 - 90 - 99 - 108 - 117 - 126 - 135 - 144 - 153 - 162
171 - 180 - 189 - 198 - 207 - 216

P	L	H	art.
4	*	50	SPIO750W
		75	SPIO775W

 Per mercato USA e Canada
For US and Canadian markets

P	L	H	art.
4	*	50	SPIO050S
		75	SPIO075S

Specchio spess. 5 mm a filo lucido con illuminazione a led luce bianca completo di telaio in acciaio lucido AISI 304.

Polished edge mirror 5 mm thick with white led lighting complete with polished stainless steel frame AISI 304.

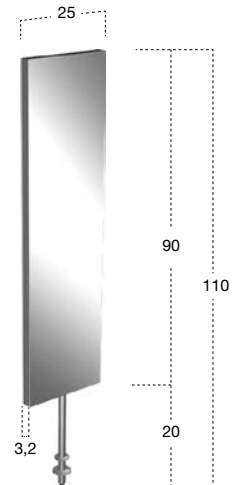
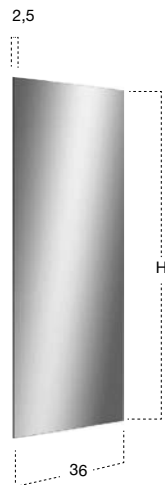

P	L	H	art.
2,5	36	90	SLOW1
		108	SLOW2

P	L	H	art.
3,2	25	110	ALTEREGO

Specchio spess. 5 mm girevole bifacciale con struttura in acciaio inox satinato AISI 304.

Double faced revolving mirror 5 mm thick with satin stainless steel structure AISI 304.

Specchio spess. 5 mm a filo lucido.

Polished edge mirror 5 mm thick.



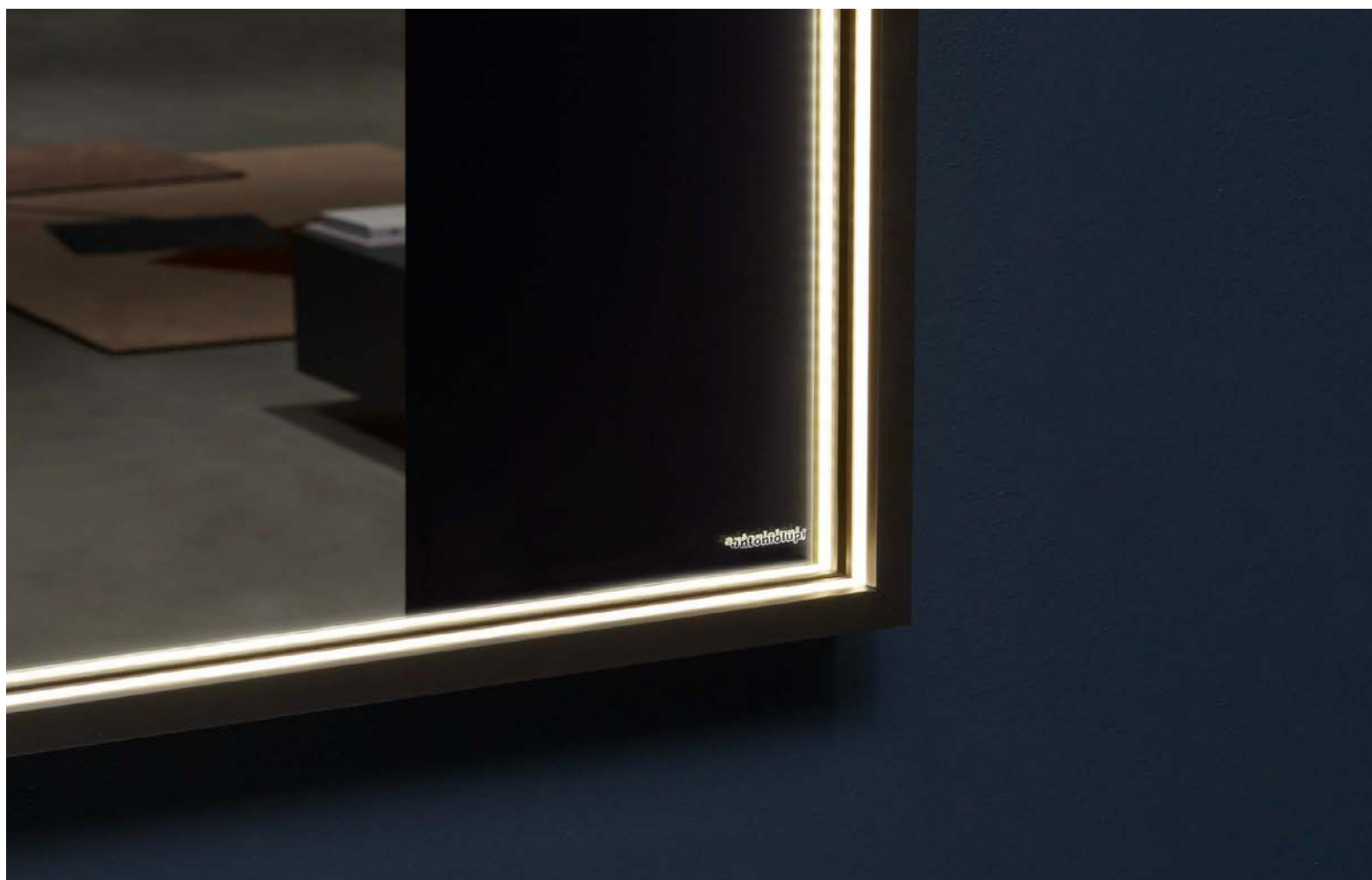

Come un quadro, un'opera d'arte, un segno rigoroso che nasce da una geometria perfetta e racchiude una o più immagini in movimento. Un perimetro preciso ma allo stesso tempo capace di suscitare emozione e sorpresa. È elegante e raffinata la cornice in alluminio finitura bronzo, che caratterizza lo specchio Edison. La luce integrata nella cornice è l'assoluta protagonista di questo sistema e definisce una delle aree più importanti della stanza da bagno conferendogli raffinatezza e fascino. Edison è disponibile in diverse dimensioni e quando è acceso conferisce un'aura magica a tutto l'ambiente.

Like a painting, a work of art, a rigorous sign that comes from perfect geometry and contains one or more moving images. A precise perimeter but at the same time capable of arousing emotion and surprise. The bronze finish aluminum frame, which characterizes the Edison mirror, is elegant and refined. The light integrated into the frame is the absolute protagonist of this system and defines one of the most important areas of the bathroom giving it refinement and charm. Edison is available in different sizes and when lit it gives a magical aura to the entire environment.

Illuminazione a LED 4000 K. Su richiesta illuminazione a LED 3000 K senza maggiorazione di prezzo.

LED lighting 4000 K. Upon request LED lighting 3000 K available without additional surcharge.

P	L	H	art.
5,4	da / from 54 a / to 216	50	EDISON50W
5,4	da / from 54 a / to 216	75	EDISON75W

Specchio spess. 4 mm a filo lucido orizzontale o verticale con cornice in alluminio finitura bronzo con illuminazione a led luce bianca.

Horizontal or vertical mirror 4 mm thick with bronze aluminum frame and white led lighting.

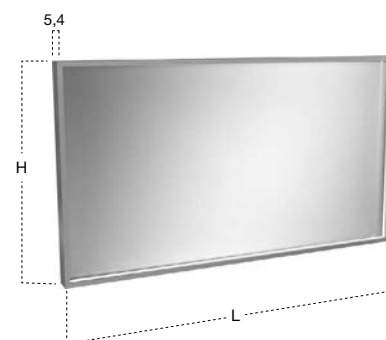



Negli specchi la luce diffusa è molto bella esteticamente e soprattutto rilassante, ma non illumina il viso, quindi per radersi o truccarsi, occorre un altro tipo d'illuminazione. BOLLA è nata per risolvere questo problema, con la sua luce morbida e diretta, posta in alto al centro o al lato dello specchio, illumina il viso uniformemente.

A scattered light is aesthetically very beautiful and relaxing when shined upon mirrors however it doesn't illuminate the face, for shaving or putting on make-up you need another type of lighting. BOLLA is born to resolve this issue with its soft yet direct light placed high in the center or to the side of the mirror illuminates the face evenly.



Ø art.

8 BOLLA

Lampada a led da specchio in vetro pyrex con supporto in alluminio, completa di lampada e trasformatore.

Led lamp in pyrex glass with aluminum support, complete with bulb and transformer.



Ø	art.
8	BOLLA2

Coppia di lampade a led da specchio in vetro pyrex con supporto in alluminio, complete di lampada e trasformatore.

Pair of led lamps in pyrex glass with aluminum support, complete with bulb and transformer.







Ø	art.
12	BOLLA1

Lampada da specchio e da parete in vetro pyrex con supporto in alluminio completa di lampada.

Mirror or wall lamp in pyrex glass with aluminum support, complete with bulb.







illuminazione a LED 4000 K. Su richiesta illuminazione a LED 3000 K senza maggiorazione di prezzo.

LED lighting 4000 K. Upon request LED lighting 3000 K available without additional surcharge.

P	L	H	art.	art.
4,2	da / from 54 a / to 216	50	BSK50	BSK50W Con illuminazione a led / With led lighting
		75	BSK75	BSK75W Con illuminazione a led / With led lighting
		90	BSK90	BSK90W Con illuminazione a led / With led lighting
		100	BSK100	BSK100W Con illuminazione a led / With led lighting
		110	BSK110	BSK110W Con illuminazione a led / With led lighting

Specchio spess. 4 mm a filo lucido orizzontale o verticale e cornice in alluminio finitura come da nostro campionario colori, con o senza illuminazione a led.

Horizontal or vertical polished edge mirror 4 mm thick and aluminum frame finish as per our colour samples, with or without led lighting

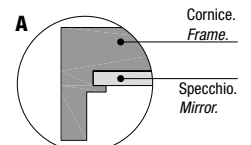
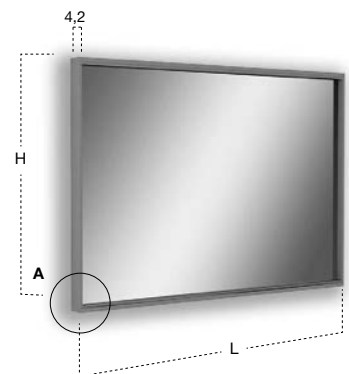



illuminazione a LED 4000 K. Su richiesta illuminazione a LED 3000 K senza maggiorazione di prezzo.

LED lighting 4000 K. Upon request LED lighting 3000 K available without additional surcharge.

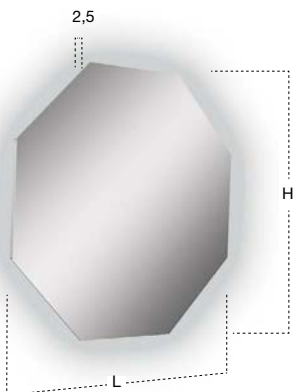

P	L	H	art.	art.
2,5	72	72	MODULO872	MODULO872W Con illuminazione a led / With led lighting
	90	90	MODULO890	MODULO890W Con illuminazione a led / With led lighting
	108	108	MODULO8108	MODULO8108W Con illuminazione a led / With led lighting

Specchio spess. 5 mm a filo lucido con o senza illuminazione a led luce bianca, completo di telaio.

Polished edge mirror 5 mm thick with or without white led lighting, complete with frame.

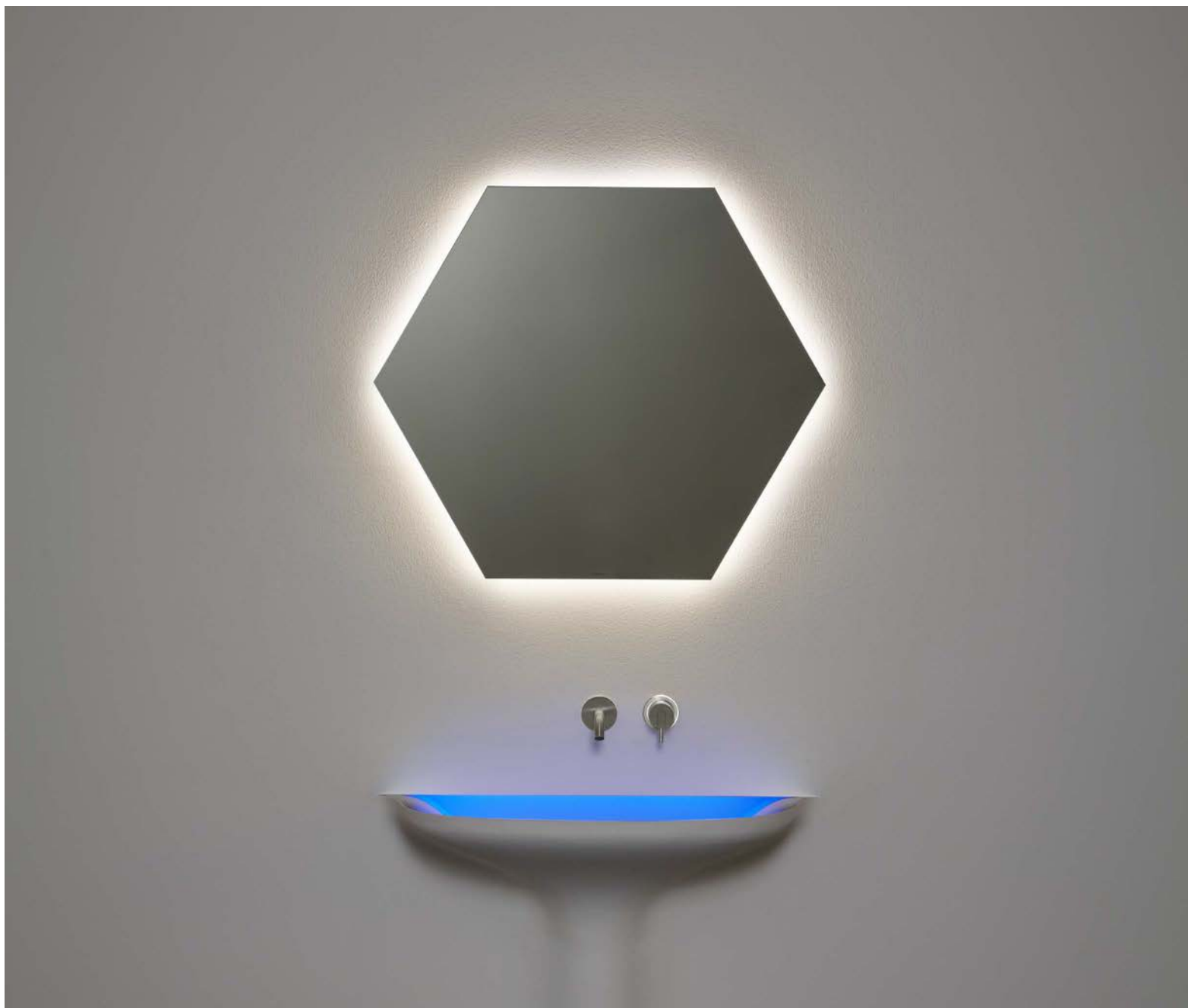

illuminazione a LED 4000 K. Su richiesta illuminazione a LED 3000 K senza maggiorazione di prezzo.

LED lighting 4000 K. Upon request LED lighting 3000 K available without additional surcharge.

P	L	H	art.	art.
2,5	72	62	MODULO672	MODULO672W Con illuminazione a led / With led lighting
	90	78	MODULO690	MODULO690W Con illuminazione a led / With led lighting
	108	94	MODULO6108	MODULO6108W Con illuminazione a led / With led lighting

Specchio spess. 5 mm a filo lucido con o senza illuminazione a led luce bianca, completo di telaio.

Polished edge mirror 5 mm thick with or without white led lighting, complete with frame.

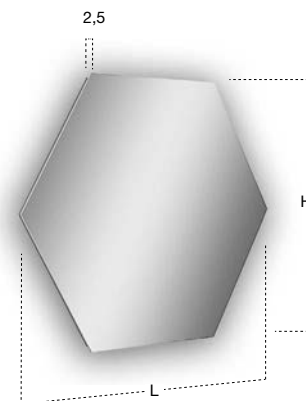





illuminazione a LED 4000 K. Su richiesta illuminazione a LED 3000 K senza maggiorazione di prezzo.

LED lighting 4000 K. Upon request LED lighting 3000 K available without additional surcharge.

CORNICE (La realizzazione della cornice è a cura del cliente)
FRAME (frame not included)

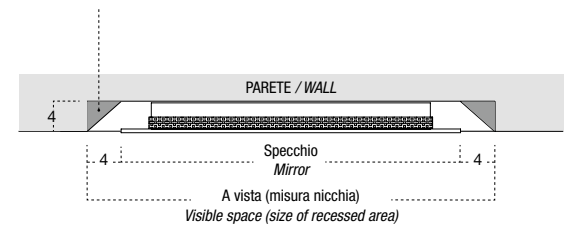

P	L	H	art.
4	da / from 64 a / to 208	42	PERIPLO

Specchio spess. 5 mm a filo lucido orizzontale o verticale con illuminazione a led luce bianca, da incasso a parete.

Encased wall mount polished edge mirror 5 mm thick with white led lighting, mounted horizontally or vertically.

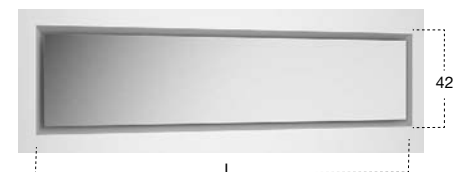





illuminazione a LED 4000 K. Su richiesta illuminazione a LED 3000 K senza maggiorazione di prezzo.

LED lighting 4000 K. Upon request LED lighting 3000 K available without additional surcharge.

P	L	H	art.	art.
4,2	54	210	BSK21054	BSK210W54 Con illuminazione a led / With led lighting
	72	210	BSK21072	BSK210W72 Con illuminazione a led / With led lighting
	90	210	BSK21090	BSK210W90 Con illuminazione a led / With led lighting

Specchio spess. 4 mm a filo lucido orizzontale o verticale e cornice in alluminio finitura come da nostro campionario colori, con o senza illuminazione a led.

Horizontal or vertical polished edge mirror 4 mm thick and aluminum frame finish as per our colour samples, with or without led lighting

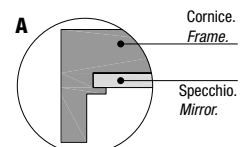
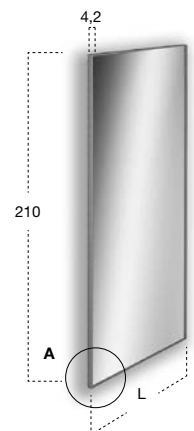





P	L	H	art.
4	180	220	DAMONE

Specchio spess. 5 mm a filo lucido con cornice a disegno completo di telaio laccato nero gofrato.

Polished edge mirror 5 mm thick complete with lacquered frame embossed black.

MANTRA

N.B. È possibile inserire 1 lampada a led superiore e 1 lampada a led inferiore.

P.S. It is possible to insert 1 led light above and 1 led light below.





Art. PRESA / PRESACH

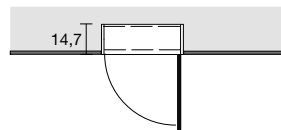
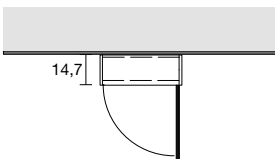
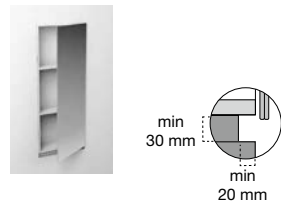
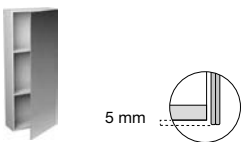

N. 2 prese di corrente per pensili.

N. 2 electrical sockets for wall cabinets.

a Pensile a parete
Wall cabinet

b Pensile incassato a parete
Encased wall cabinet

P	L	H	art.
14,7	36/45/54	50	MANTRA150
		75	MANTRA175
		90	MANTRA190

Pensile dx o sx con 1 anta a specchio bifacciale e 1 ripiano interno per H 50 cm o 2 ripiani interni per H 75 e H 90 cm.

Right or left wall cabinet with 1 double face mirrored door and 1 internal shelf for H 50 cm or with 2 internal shelves for H 75 and H 90 cm.

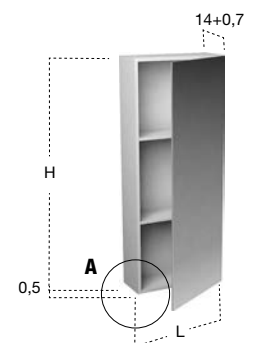
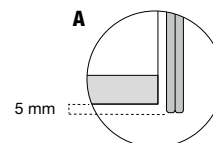



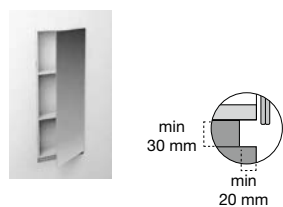
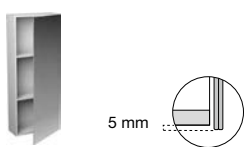

Art. PRESA / PRESACH



N. 2 prese di corrente per pensili.

N. 2 electrical sockets for wall cabinets.

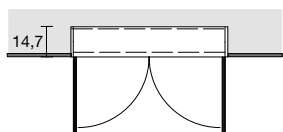
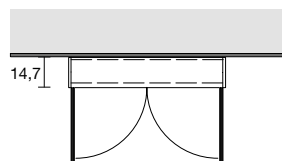

a Pensile a parete
Wall cabinet

b Pensile incassato a parete
Encased wall cabinet

P	L	H	art.
14,7	72/90/108	50	MANTRA250
		75	MANTRA275
		90	MANTRA290

Pensile con 2 ante a specchio bifacciali e 1 ripiano interno per H 50 cm o 2 ripiani interni per H 75 e H 90 cm.

Wall cabinet with 2 double face mirrored door and 1 internal shelf for H 50 cm or with 2 internal shelves for H 75 and H 90 cm.

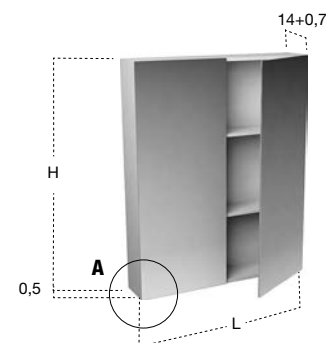
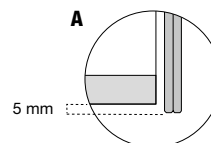



Su richiesta è possibile inserire all'interno dell'anta un secondo specchio.

On request it is possible to insert a second mirror on the inside of the door front.



P	L	H	art.
21,6	36	37,5	KE1136
	45	37,5	KE1145

P	L	H	art.
21,6	72	37,5	KE3172
	90	37,5	KE3190

P	L	H	art.
21,6	36	50	KE1436
	45	50	KE1445
	54	50	KE1454

P	L	H	art.
21,6	72	50	KE3472
	90	50	KE3490
	108	50	KE34108

Pensile con 1 o 2 ante e 1 ripiano interno solo per H 50 cm.

Wall cabinet with 1 or 2 doors and 1 internal shelf for H 50 cm.

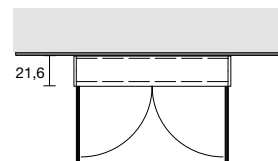

a Pensile a parete
Wall cabinet

Art. KE1136 / KE1145
Versione sx / Left version

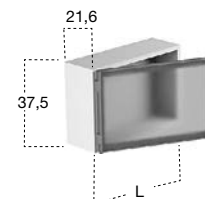

Art. KE1436 / KE1445 / KE1454
Versione sx / Left version

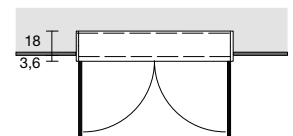
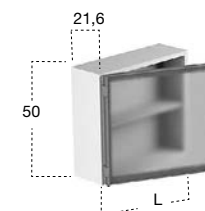

b Pensile semincasso a parete
Semi-encased wall cabinet

Art. KE3172 / KE3190

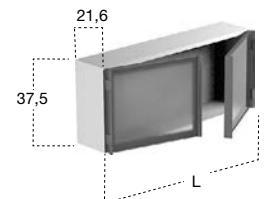

Art. KE3472 / KE3490 / KE34108

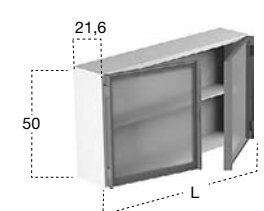



N.B. Da L 72 a L 108 cm è possibile inserire 1 lampada,
da L 117 a L 216 cm è possibile inserire 2 lampade a led.

*P.S. From L 72 to L 108 cm it's possible to use 1 light, from L
117 to L 216 cm it's possible to use 2 led lights.*

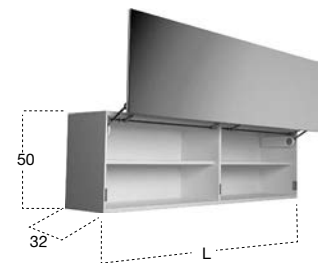

Specchio.
Mirror.

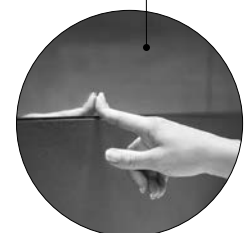

P	L	H	art.
32	da / from 72 a / to 216	50	SEGRETO

Pensile con anta a specchio ad apertura verticale, mediante sistema elettrico con possibile inserimento di illuminazione a led.

Wall cabinet with vertical electrical flap-opening door. Upon request it can be produced with internal led lighting.





TEATRO

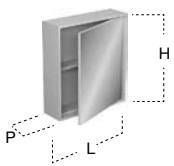

P	L	H	art.
14	27/36/45/54	50	TEATRO15014
		75	TEATRO17514
		100	TEATRO10014
		125	TEATRO12514

P	L	H	art.
22	27/36/45/54	50	TEATRO15022
		75	TEATRO17522
		100	TEATRO10022
		125	TEATRO12522

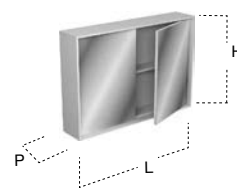

P	L	H	art.
14	54/72/90/108	50	TEATRO25014
		75	TEATRO27514

P	L	H	art.
22	54/72/90/108	50	TEATRO25022
		75	TEATRO27522

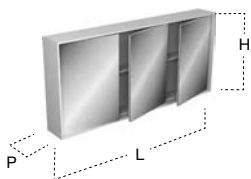

P	L	H	art.
14	81/108/135/162	50	TEATRO35014
		75	TEATRO37514

P	L	H	art.
22	81/108/135/162	50	TEATRO35022
		75	TEATRO37522

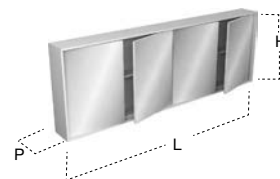

P	L	H	art.
14	108/144/180/216	50	TEATRO45014
		75	TEATRO47514

P	L	H	art.
22	108/144/180/216	50	TEATRO45022
		75	TEATRO47522

Versione sx / Left version

N.B. È possibile inserire 1 lampada a led superiore.
 P.S. It is possible to insert 1 led light above.



1 Prof. 14 cm / 14 cm D.

14

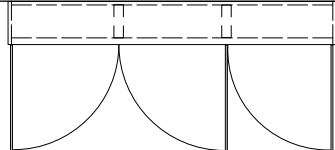

1a Pensile a parete
 Wall cabinet

8

6

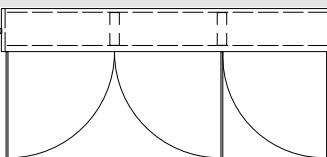

1b Pensile semincassato a parete
 Semi-encased wall cabinet

14

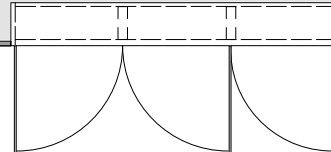

1c Pensile incassato a parete
 Encased wall cabinet

2 Prof. 22 cm / 22 cm D.

22

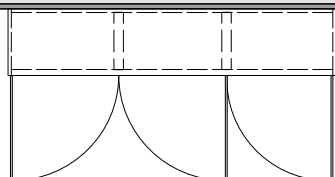

2a Pensile a parete
 Wall cabinet

8

14

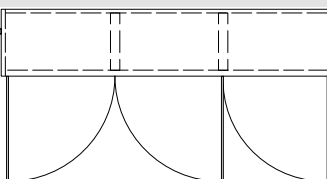

2b Pensile semincassato a parete
 Semi-encased wall cabinet

22

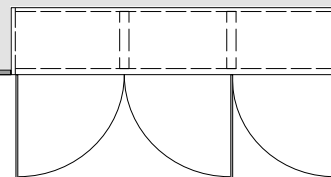

2c Pensile incassato a parete
 Encased wall cabinet

Pensile con anta a specchio bifacciale.

Wall cabinet with double face mirrored door.





LUXOR

cristallo argentato rosé / rosé silvered glass





LUXOR

cristallo argentato bronzo / *bronze silvered glass*



cristallo argentato bronzo / bronze silvered glass



LUXOR

crystallo argentato fumé / *fumé silvered glass*





Specchio spess. 5 mm tondo molato.

Beveled round mirror 5 mm thick.

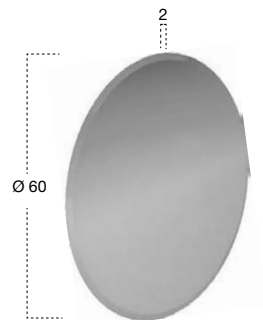

P	∅	art.	
2	60	LUXOR1	

Specchio spess. 5 mm quadrato molato.

Beveled square mirror 5 mm thick.

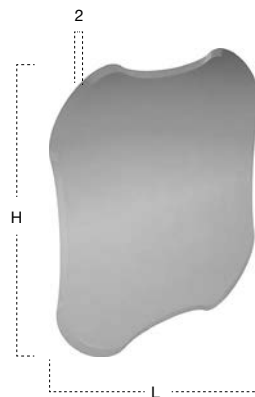

P	L	H	art.
2	75	75	LUXOR475
	90	90	LUXOR490

Specchio spess. 5 mm ovale orizzontale o verticale molato.

Horizontal or vertical beveled oval mirror 5 mm thick.

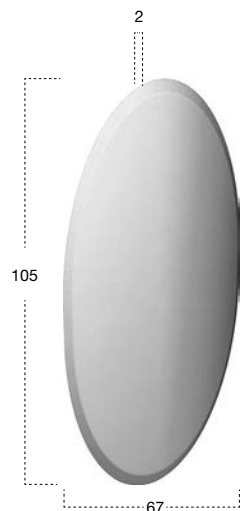

P	L	H	art.
2	67	105	LUXOR2

Specchio spess. 5 mm rettangolare orizzontale o verticale molato.

Horizontal or vertical beveled rectangular mirror 5 mm thick.

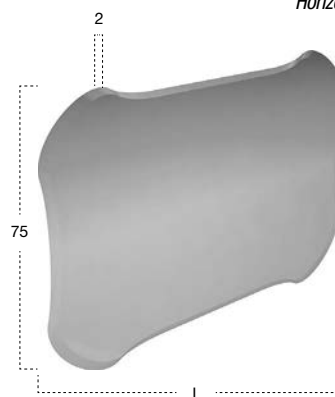

P	L	H	art.
2	117	75	LUXOR5117
	126	75	LUXOR5126

Specchio spess. 5 mm tondo molato.

Beveled round mirror 5 mm thick.

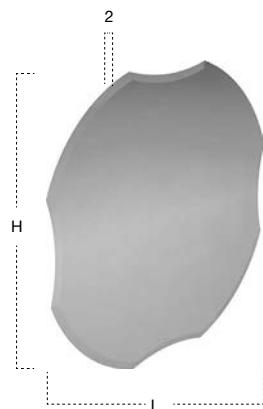

P	L	H	art.
2	75	75	LUXOR375
	90	90	LUXOR390

Specchio spess. 5 mm ovale orizzontale o verticale molato.

Horizontal or vertical beveled oval mirror 5 mm thick.

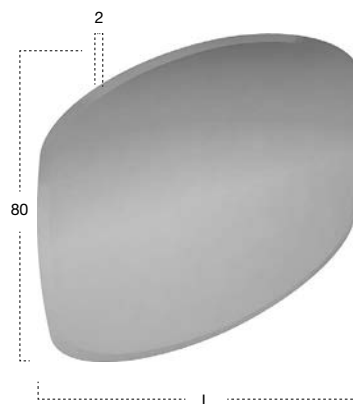

P	L	H	art.
2	117	80	LUXOR6117
	126	80	LUXOR6126

Specchio spess. 5 mm tondo molato con cornice in cristallo colorato argentato disponibile nei diversi colori: fumé, bronzo, rosé, blu, acquamarina.

Round beveled mirror 5 mm thick with a coloured and silvered glass frame available in various colours: fumé, bronze, rosé, blu and acquamarina.

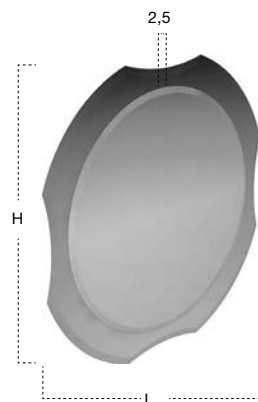

Specchio spess. 5 mm rettangolare orizzontale o verticale molato con cornice in cristallo colorato argentato disponibile nei diversi colori: fumé, bronzo, rosé, blu, acquamarina.

Rectangular beveled mirror 5 mm thick horizontal or vertical, with a coloured and silvered glass frame available in various colours: fumé, bronze, rosé, blu and acquamarina.

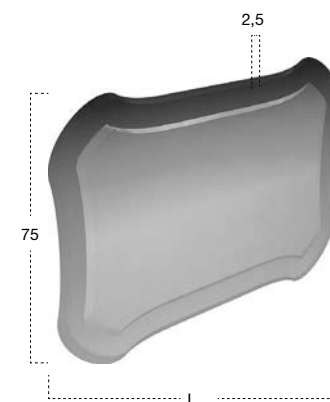

P	L	H	art.
2,5	75	75	LUXOR775
	90	90	LUXOR790

Specchio spess. 5 mm quadrato con cornice in cristallo colorato argentato disponibile nei diversi colori: fumé, bronzo, rosé, blu e acquamarina.

Round beveled mirror 5 mm thick with a coloured and silvered glass frame available in various colours: fumé, bronze, rosé, blu and acquamarina.

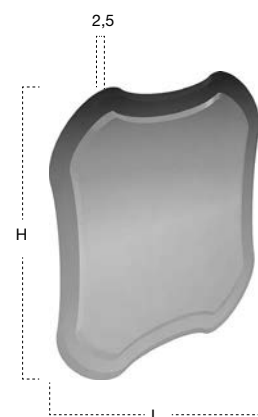

P	L	H	art.
2,5	75	75	LUXOR875
	90	90	LUXOR890

P	L	H	art.
2,5	117	75	LUXOR9117
	126	75	LUXOR9126

Specchio spess. 5 mm ovale orizzontale o verticale, molato con cornice in cristallo colorato argentato disponibile nei diversi colori: fumé, bronzo, rosé, blu e acquamarina.

Oval beveled mirror 5 mm thick horizontal or vertical, with a coloured and silvered glass frame available in various colours: fumé, bronze, rosé, blu and acquamarina.

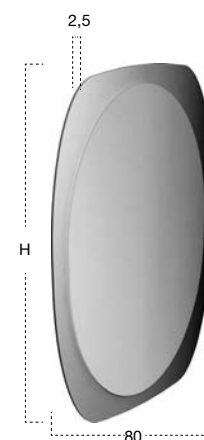

P	L	H	art.
2,5	117	80	LUXOR10117
	126	80	LUXOR10126

RONDÒ design Roberto Lazzeroni

Lampada da parete a led in vetro bronzo soffiato con supporti in ottone cromo lucido completa di 2 lampade.

LED wall lamp with blown bronze glass and polished brass supports complete with 2 bulbs.





Art. FORMA85

Art. FORMA54

Art. FORMA154

P	Ø	art.	
8,5	85	FORMA85	
P	L	H	art.
8,5	54	85	FORMA54
	54	185	FORMA154

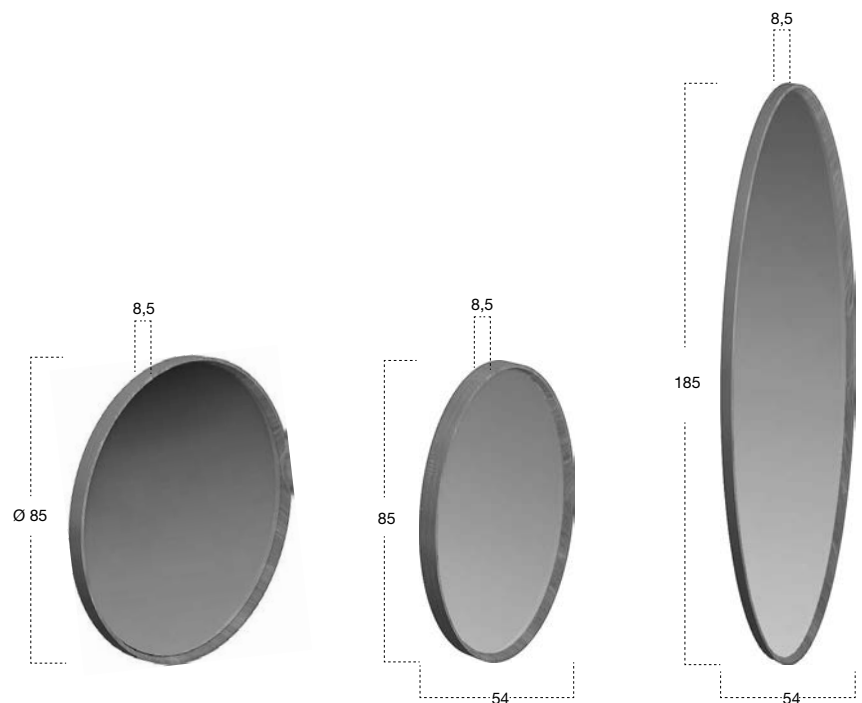

Specchio spess. 5 mm molato con cornice in massello di legno.

Round beveled mirror 5 mm thick with solid wood frame.

INFORMAZIONI ENERGETICHE *ENERGETIC INFORMATION*

Articoli muniti di lampade a led integrate di classe energetica A non sostituibili

Articles provided with integrated led bulbs of energy class A not replaceable

APICE50W	FILA75W	MODULO672W	NTKIT125W	SPIO150W	TEATRO47514
BATTIGIAL	FILA90W	MODULO690W	NTKIT142W	SPIO175W	TEATRO47522
BATTIGIAML	FLASH50W	MODULO6108W	NTKIT210W54	SPIO250W	TEATRO10014
BOLLA	FLASH75W	MODULO872W	NTKIT210W72	SPIO275W	TEATRO10022
BOLLA2	FLASH90W	MODULO890W	NTKIT210W90	SPIO650W	TEATRO12514
BSK50W	FLASH100W	MODULO8108W	OMBRAL	SPIO675W	TEATRO12522
BSK75W	FMS10	NEULUCE1	ORMA50W	SPIO750W	VARIO50W
BSK90W	FMS20	NEUTRO210W54	ORMA75W	SPIO775W	VARIO75W
BSK100W	FMS20C	NEUTRO210W72	ORMA90W	STRAPPOL	VARIO90W
BSK110W	INTRECCIOL	NEUTRO210W90	ORMA110W	STRAPPOXLL	VARIO100W
BSK210W54	LUMEN	NEUTRO1144W45	PERIPL0	TEATRO15014	VARIO110W
BSK210W72	MANTRA150	NEUTRO1180W45	SEGRETO	TEATRO15022	VERTICE75W
BSK210W90	MANTRA175	NEUTROLED50W	SFOGLIA250	TEATRO25014	VERTICE90W
CALICEL	MANTRA190	NEUTROLED75W	SFOGLIA275	TEATRO25022	
CIRCUS72W	MANTRA250	NEUTROLED90W	SFOGLIA290	TEATRO35014	
CIRCUS90W	MANTRA275	NEUTROLED100W	SFOGLIA2108	TEATRO35022	
CIRCUS108W	MANTRA290	NEUTROLED110W	SFOGLIA75L	TEATRO45014	
CIRCUS120W	METE01	NEUTROLED125W	SILENZIOL	TEATRO45022	
CIRCUS140W	METE02	NEUTROLED142W	SOFFIOL	TEATRO17514	
CIRCUS180W	METE02C	NTKIT50W	SPIO1W	TEATRO17522	
CIRCUS190W	METE03C	NTKIT75W	SPIO2W	TEATRO27514	
CIRCUS1108W	METE0_INL	NTKIT90W	SPIO3W	TEATRO27522	
EDISON50W	METE0_OUTL	NTKIT100W	SPIO4W	TEATRO37514	
EDISON75W	METE0XXL	NTKIT110W	SPIO5W	TEATRO37522	

Articoli venduti con lampade di classe energetica A e compatibili con lampade di classe energetica A++, A+ e A

Articles sold with bulbs of energy class A and compatible with bulbs of energy classes A++, A+ and A

RONDÓ1

Articoli venduti con lampade di classe energetica A e compatibili con lampade di classe energetica A, B, C, D, E

Articles sold with bulbs of energy class A and compatible with bulbs of energy classes A, B, C, D, E

BOLLA1

Articoli muniti di lampade a led integrate di classe energetica A+ non sostituibili

Articles provided with integrated led bulbs of energy class A+ not replaceable

IRIDE

LUCENTE45
LUCENTE54
LUCENTE63
LUCENTE72
LUCENTE81
LUCENTE90
LUCENTE99
LUCENTE108
LUCENTE117
LUCENTE126
LUCENTE135
LUCENTE144
LUCENTE153
LUCENTE162
LUCENTE171
LUCENTE180
LUCENTE189
LUCENTE198
LUCENTE207
LUCENTE216
ZENITLED

Etichette energetiche disponibili su www.antoniolupi.it - Energy labels available on www.antoniolupi.it



Scarica l'App su App Store e Google Play per entrare nel mondo antoniolupi

Download the App on App Store and Google Play to discover the world of antoniolupi

www.antoniolupi.it

Per essere costantemente informati su novità e prodotti in modo dettagliato, vi invitiamo a navigare nel nostro sito sempre aggiornato. Nell'area download potrete scaricare tutto il materiale tecnico ed informativo che vi necessita.

To constantly be up to date in a detailed manner on novelties and products please navigate through our website. In the download area you can find all the necessary technical information.



Prodotto interamente in Italia.

Entirely made in Italy.

© Antonio Lupi Design S.p.A. 2019

NOTA: alla Antonio Lupi Design S.p.A. è riservata la facoltà di apportare ai propri modelli qualsiasi modifica estetica, tecnica, nelle dimensioni e nei colori, ritenuta necessaria, nonché la facoltà di sospendere la produzione in qualunque momento senza preavviso, rinunziata fin d'ora da parte del committente ogni conseguente richiesta risarcitoria. Si declina ogni responsabilità relativa ad eventuali inesattezze contenute in questo catalogo, se dovute ad errori di stampa o trascrizioni. Nessun contenuto di questo catalogo può essere copiato, riprodotto anche parzialmente, ripubblicato, trasmesso o distribuito in qualunque forma, senza autorizzazione scritta dell'Antonio Lupi Design S.p.a.

NOTE: Antonio Lupi Design S.p.A. reserves the right to make any and all necessary esthetic, technical, colour or size modifications in order to enhance use and esthetic value, and may suspend the production cycle at any moment without notice. Such instances may not be subject to claim by the client. We decline all responsibilities for any possible uncertainties due to misprints in this catalogue. None of the material in this catalogue can be copied, reproduced, republished or distributed in any or partial way unless a written authorization is given from the company Antonio Lupi Design S.p.a.

antoniolupi

73

VIA MAZZINI

75

Antonio Lupi Design S.p.A.
via Mazzini 73/75 - 50050 Stabbia
Cerreto Guidi (Firenze) - Italy
T +39 0571 586881_95651
F +39 0571 586885
www.antoniolupi.it
lupi@antoniolupi.it

