

# CATALOGO GENERALE \_2

SOFFIONI  
*SHOWER*

RUBINETTERIA  
*TAPS*

PIATTI E BOX DOCCIA  
*SHOWER ENCLOSURES*

SANITARI  
*SANITARY - WARE*

TERMOARREDI  
*DESIGNER RADIATOR*

VASCHE  
*TUBS*

COMPLEMENTI E ACCESSORI  
*FURNISHINGS - ACCESSORIES*

TAPPETI  
*CARPETS*



**antoniolupi**

MADE IN ITALY



L'eccellenza nel bagno ha un'anima toscana  
Excellence in the bathroom has a Tuscan soul

**antoniolupi**

MADE IN ITALY

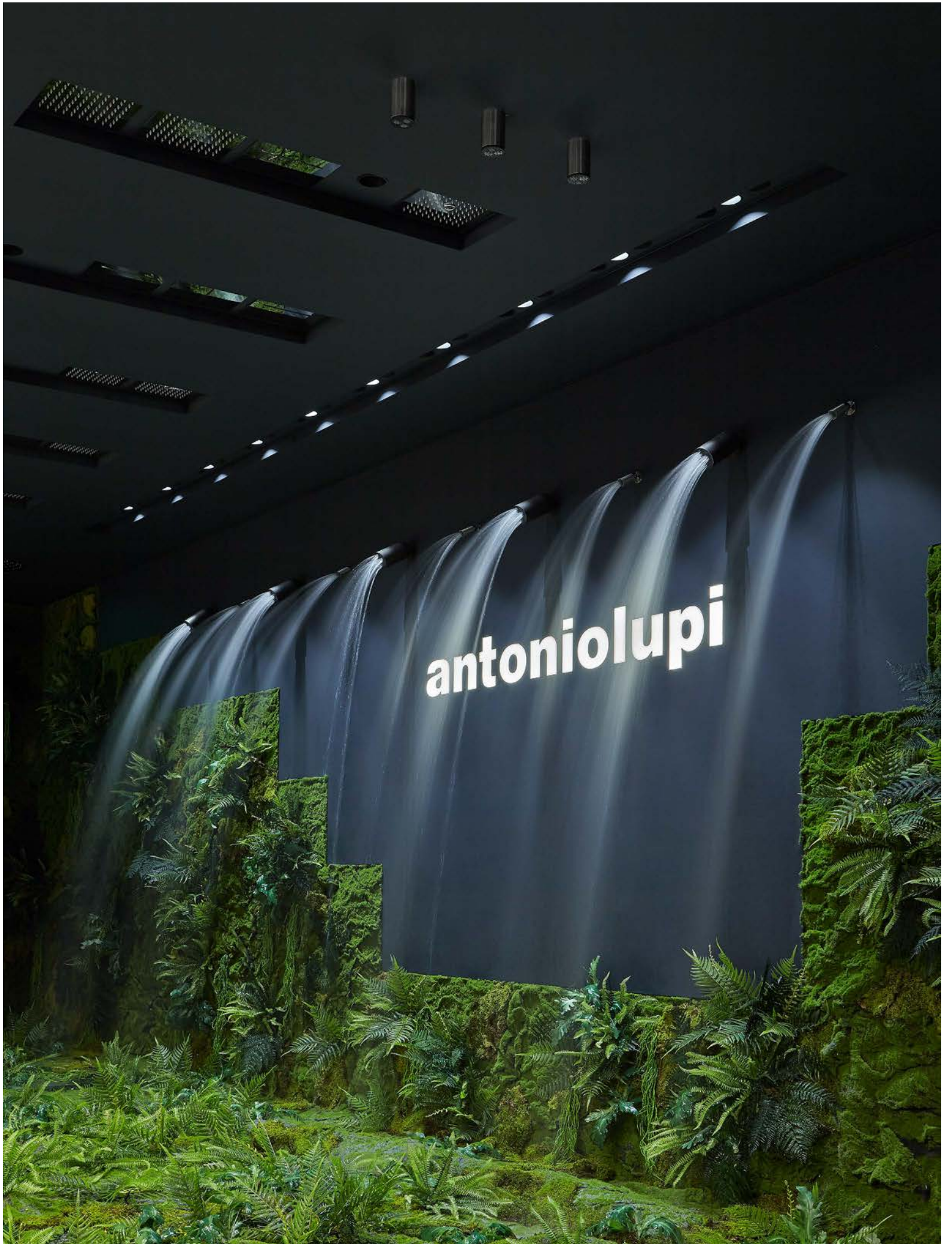

**CATALOGO  
GENERALE  
VOL.2**



# SOFFIONI *SHOWER HEADS*

# AZIMUT

\_2017

design

GI-RA

Modello e design registrato, brevetto depositato

*Registered model and design, patent filed*

Un cilindro perfetto, compatto, essenziale, preciso, una forma che rimanda immediatamente ad altre funzioni, un'immagine che è la perfetta sintesi di tecnologia e design: AZIMUT è il soffione a soffitto e a parete in acciaio inox e Delrin nero, che ha nello snodo speciale il cuore del progetto. Un dettaglio tecnico che diventa estetico, un particolare che fa la differenza, un concept che mette la funzionalità evoluta al primo posto. Lo snodo permette infatti al soffione di ruotare e quindi orientare il getto d'acqua per più di 180° rispetto a un asse. Una caratteristica che ne moltiplica le possibilità d'utilizzo garantendo una maggiore flessibilità di installazione. AZIMUT si può applicare a parete o a soffitto a seconda delle esigenze ed è in grado di orientare il getto d'acqua in base alle caratteristiche fisiche dell'utente per garantire il massimo relax. Un progetto che ridefinisce l'archetipo del soffione, un oggetto che migliora la qualità dello spazio doccia, un dettaglio che riscrive una gestualità consolidata. Lo snodo è stato realizzato con una cremagliera che genera un piacevole effetto a scatto e allo stesso tempo permette di tenere fermo il soffione nella posizione desiderata. Come in tutte le collezioni di antoniolupi l'estetica svolge un ruolo fondamentale nella definizione del progetto. La sofisticata eleganza dell'acciaio satinato, gli equilibri proporzionali misurati e la compattezza della forma ne fanno un oggetto dall'anima contemporanea.

*A perfect cylinder, compact, essential, precise, an image that is the perfect synthesis of technology and design: AZIMUT is the ceiling and wall showerhead in stainless steel and black Delrin with a special rotation which is the heart of the project. A technical detail that becomes aesthetic, a peculiarity that makes the difference, a concept that puts an evolved functionality first. The hinge allows the showerhead to rotate and then direct the jet more than 180°. A feature that multiplies the possibilities of use, providing greater flexibility in the installation. AZIMUT can be applied to the wall or ceiling depending on the needs and is able to orient the jet of water according to the physical characteristics of the user to ensure maximum relaxation. A project that redefines the archetype of the showerhead, an object that improves the quality of the showering space, a detail that rewrites a consolidated gesture. The movement has been made with a device that generates a pleasant snap effect and at the same time keeps the head firm in the desired position. As in all the collections of antoniolupi aesthetics plays a key role in defining the project. The sophisticated elegance of satin steel, measured proportional balance and compactness make it an object of the contemporary soul.*













antoniolupi







acciaio inox satinato  
satin stainless steel

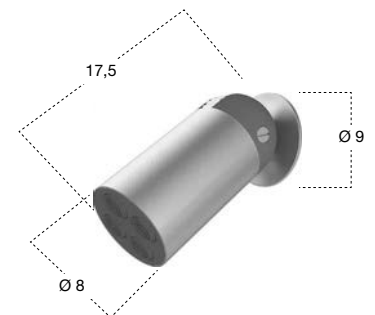

H	P	Ø	art.
9	17,5	8	AZIMUT

Soffione a parete o a soffitto in acciaio inox AISI 304 e Delrin nero, con regolazione del getto, disponibile anche in finitura grafite.

Wall or ceiling showerhead in stainless steel AISI 304 and black Delrin, with jet regulation, also available in graphite finish.

# MINIAZIMUT

\_2018

design

GI-RA

Modello e design registrato, brevetto depositato

*Registered model and design, patent filed*

Un cilindro perfetto, essenziale, preciso, oggi disponibile anche nella versione ridotta, con dimensioni ancora più compatte. Una forma che rimanda immediatamente ad altre funzioni, un'immagine che è la perfetta sintesi di tecnologia e design: MINIAZIMUT è l'evoluzione di AZIMUT, il soffione a soffitto e a parete che rimanda all'immagine di un proiettore luminoso che emette al posto della luce, l'energia vitale dell'acqua. Nel solco di quanto sta avvenendo nel mondo dell'illuminazione con la miniaturizzazione delle sorgenti e la conseguente riduzione delle dimensioni dei corpi, anche AZIMUT si restringe e diventa MINIAZIMUT, anch'esso disponibile nelle finiture Acciaio Inox Satinato o Grafite oltre che in alcune parti in Delrin nero. Un soffione che ha nello snodo speciale il cuore del progetto, un dettaglio tecnico che diventa estetico, un concept che mette la funzionalità evoluta al primo posto. Lo snodo permette infatti al soffione di ruotare e quindi orientare il getto d'acqua per più di 180° rispetto a un asse. Una caratteristica che ne moltiplica le possibilità d'utilizzo garantendo una maggiore flessibilità di installazione. AZIMUT si può applicare a parete o a soffitto a seconda delle esigenze ed è in grado di orientare il getto d'acqua in base alle caratteristiche fisiche dell'utente per garantire il massimo relax. Lo snodo è stato realizzato con una cremagliera che genera un piacevole effetto a scatto e allo stesso tempo permette di tenere fermo il soffione nella posizione desiderata.

*A perfect, essential, precise cylinder, now also available in the reduced version with even more compact dimensions. A form that immediately refers to other functions, an image that is the perfect synthesis of technology and design: MINIAZIMUT is the evolution of AZIMUT, the ceiling and wall showerhead that refers to the image of a luminous projector that emits, instead of light, the vital energy of water. In the wake of what is happening in the lighting world with the miniaturization of the sources and the consequent reduction in body size, AZIMUT also shrinks and becomes MINIAZIMUT, available in Satin Stainless Steel or Graphite finishes and some parts in black Delrin. A showerhead that has the heart of the project in its special joint, a technical detail that becomes aesthetic, a concept that puts evolved functionality in first place. In fact, the joint allows the showerhead to rotate and then orient the jet of water by more than 180 ° with respect to an axis. A feature that multiplies the possibilities of use ensuring greater flexibility of installation. AZIMUT can be applied to the wall or ceiling according to the needs and is able to direct the jet of water according to the physical characteristics of the user to ensure maximum relaxation. The joint has been made with a rack that generates a pleasant snap effect and at the same time allows to hold the showerhead in the desired position.*









acciaio inox satinato  
*satin stainless steel*



grafite  
graphite

H	P	Ø	art.
4,5	8,4	3	MINIAZIMUT

Soffione a parete o a soffitto in acciaio inox AISI 304 e Delrin nero, con regolazione del getto, disponibile anche in finitura grafite.

Wall or ceiling showerhead in stainless steel AISI 304 and black Delrin, with jet regulation, also available in graphite finish.

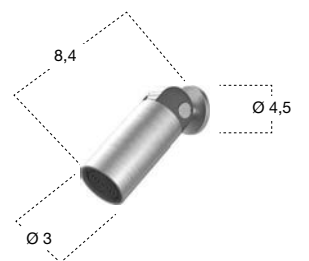

# SPRAY

\_2019

design  
AL Studio



Essenziale nella sua forma geometrica perfetta, elegante nel suo andare oltre qualsiasi velleità decorativa, performante nel saper conferire potenza al getto d'acqua.

Come uno spray, a cui deve il nome, capace di scatenare forza e vigore per un rigenerante relax. Il tutto concentrato in un cilindro dalle dimensioni contenute, minime.

Un diametro di soli 6 cm, un'altezza di 10 cm, per sprigionare un getto potente ed efficace. Spray è il minisoffione da soffitto, realizzato in acciaio inox e delrin nero, che "buca" la superficie per portare benessere nello spazio doccia.

*Essential in its perfect geometrical shape, elegant and performing while conferring power to the water jet.*

*As a spray, hence its name, this small cylinder is the perfect showerhead for a regenerating and relaxing bath.*

*A diameter of only 6 cm with 10 cm height to emanate a strong and effective jet. Spray is a ceiling mini-showerhead in stainless steel and black Delrin, which "drills" the surface to bring wellness in the shower.*

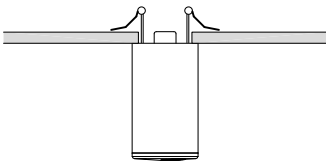

H	Ø	art.
10,6	6	SPRAY

Soffione a soffitto in acciaio satinato inox AISI 304 e Delrin nero.

*Ceiling showerhead in satin stainless steel AISI 304 and black Delrin.*

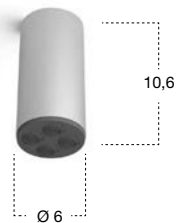

# METEO

\_2011

design

Nevio

Tellatin

Modello e design registrato, brevetto depositato

*Registered model and design, patent filed*

MINIMALISMO

ALTA INNOVAZIONE tecnologica

CROMOTERAPIA

*MINIMALISM*

*HIGH technological INNOVATION*

*CROMOTHERAPY*

Un progetto caratterizzato da estremo rigore che associa minimalismo formale ad alta innovazione tecnologica, uniti nell'obiettivo di trasmettere emozionalità e sensazioni uniche.

*A project characterized by extreme rigor which associates minimalism with a high technological innovative united in conveying emotion and unique sensations.*



METEO,  
LE PREVISIONI DEL TEMPO SI AVVERANO SEMPRE.

*METEO,  
THE WEATHER FORECAST ALWAYS COME TRUE.*

I soffioni METEO sono disponibili con o senza illuminazione a LED RGB.

*The METEO showerheads are available with or without RGB LED lighting.*





METEO

UNA BELLA DOCCIA  
*A WONDERFUL SHOWER*

Una bella doccia

Uno dei “piccoli” piaceri della vita è farsi una bella doccia all’inizio di un nuovo giorno o alla sera al rientro dal lavoro e perché il piacere sia tale, il getto del soffione deve essere potente al punto giusto, deve avere più funzioni, deve cullarci quando lo desideriamo magari con le micro gocce dei nebulizzatori, o svegliarci e tonificarci con il chiodo e la cascata, quando ne sentiamo il bisogno: solo così infatti possiamo riprodurre in casa quella sensazione di benessere e di relax che possiamo provare in una SPA.

Chi ha inventato il soffione SPA incassato nel soffitto?

antoniolupi, per prima, già nel 2011, ha brevettato METEO, il soffione che riassume in sé tutte le caratteristiche e la ricerca di effetti il più possibile naturali, di una vera e propria SPA: doccia centrale, doccia perimetrale, cascata, chiodo, nebulizzatori ed anche la funzione di cromoterapia, utilizzando luci a LED gestite da un telecomando, tonificanti nelle gradazioni che vanno dal giallo al rosso, energizzanti nei toni del rosso fino al giallo, rilassanti nei toni dal blu al verde, potendo scegliere in tutta la gamma dei colori RGB.

Come in una foresta tropicale, come sotto una cascata o sotto la pioggia

METEO è stato studiato per riprodurre, protetti nel nostro bagno, le sensazioni che la natura può darci: l’ampia superficie, il numero e la disposizione degli ugelli e dei getti, il posizionamento in alto a soffitto, tutto è stato pensato perché fare una doccia possa divenire uno dei momenti più belli della giornata.

La qualità dei materiali e la cura della realizzazione che insieme al design sono tratti distintivi della nostra azienda, assicurano poi durata e facilità di manutenzione, METEO è realizzato in acciaio inossidabile, con lavorazione artigianale di precisione, gli ugelli sono in materiale silconico di alta qualità e anticalcare, sostituibili in caso di usura.

*A wonderful shower*

*One of the “little” pleasures in life is to take a shower at the beginning of a new day or in the evening upon return from work. For it to be pleasing the jet of the showerhead must be powerful at the right point, it must have several functions, it must cradle us when we need it, maybe, with micro drops of nebulizers, or wake us up and invigorate us with a nail jet and a waterfall when we feel the need: only so can we reproduce at home that feeling of well being and relaxation that we can feel at a SPA .*

*Who invented the SPA showerhead embedded in the ceiling*

*antoniolupi, already in 2011 patented METEO, the showerhead that sums up all the characteristics and the search for effects as natural as possible, of a real SPA: central shower, perimeter shower, waterfall, nail jet, nebulizers and also the chromotherapy function using LED lights managed by a remote control, invigorating shades ranging from yellow to red, energizing shades from red to yellow, relaxing shades from blue to green, being able to choose from the entire range of RGB colors.*

*Like in a tropical forest, like under a waterfall or in the rain*

*Meteo was designed to reproduce, protected in our bathroom, the sensations that nature can give us: the large surface, the number and the arrangement of the nozzles and jets, the positioning within the ceiling, everything has been thought out because taking a shower can become one of the most beautiful moments of the day.*

*The quality of the materials and the care of the realization that together with the design are hallmarks of our company ensure durability and ease of maintenance. Meteo is made of stainless steel, with precision craftsmanship, the anti-scale nozzles are made of high quality silicone replaceable in case of wear.*



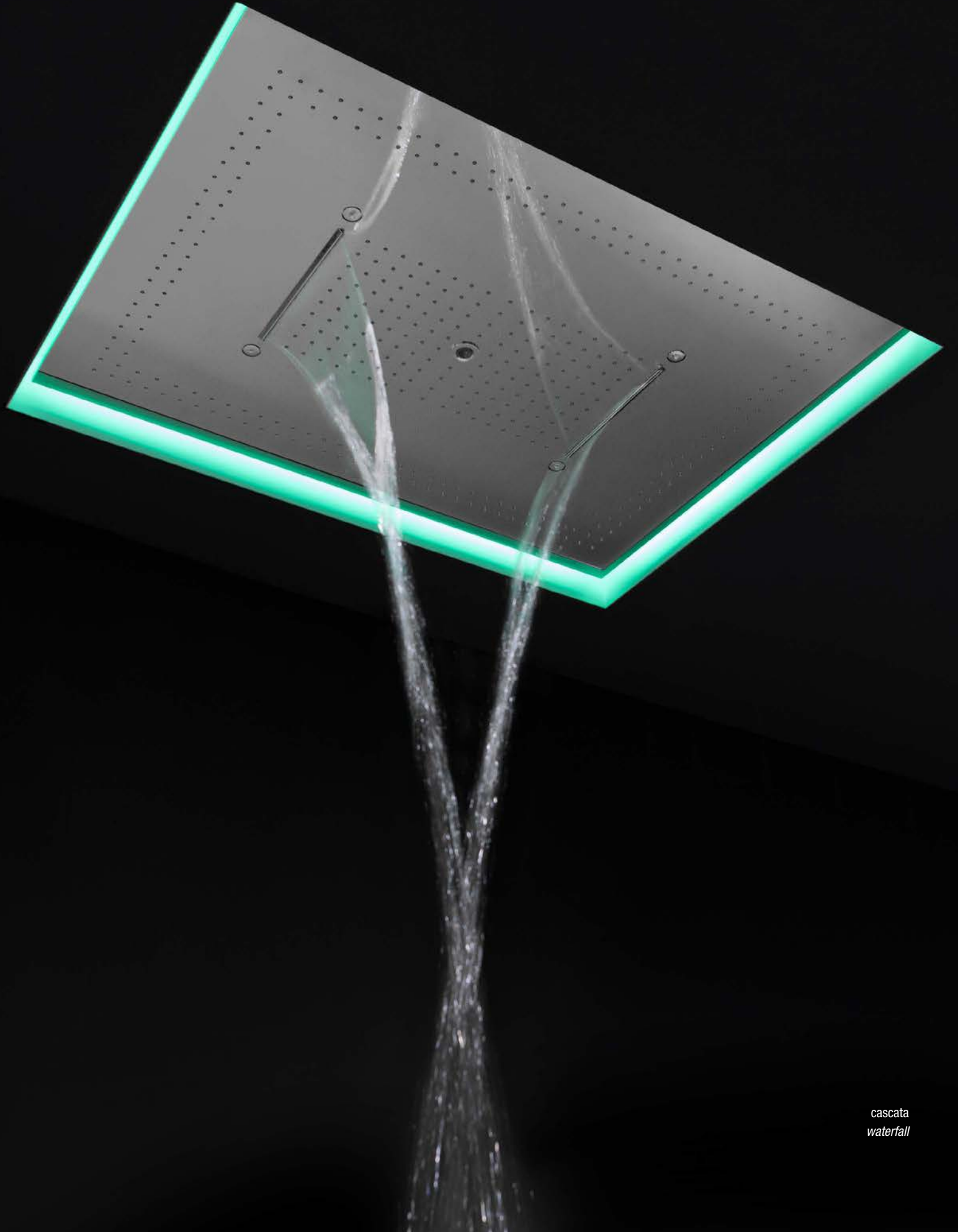

*cascata  
waterfall*



doccia perimetrale  
*perimeter shower*



doccia centrale  
*central shower*



chiodo  
*jet*



nebulizzatori  
*nebulizer*

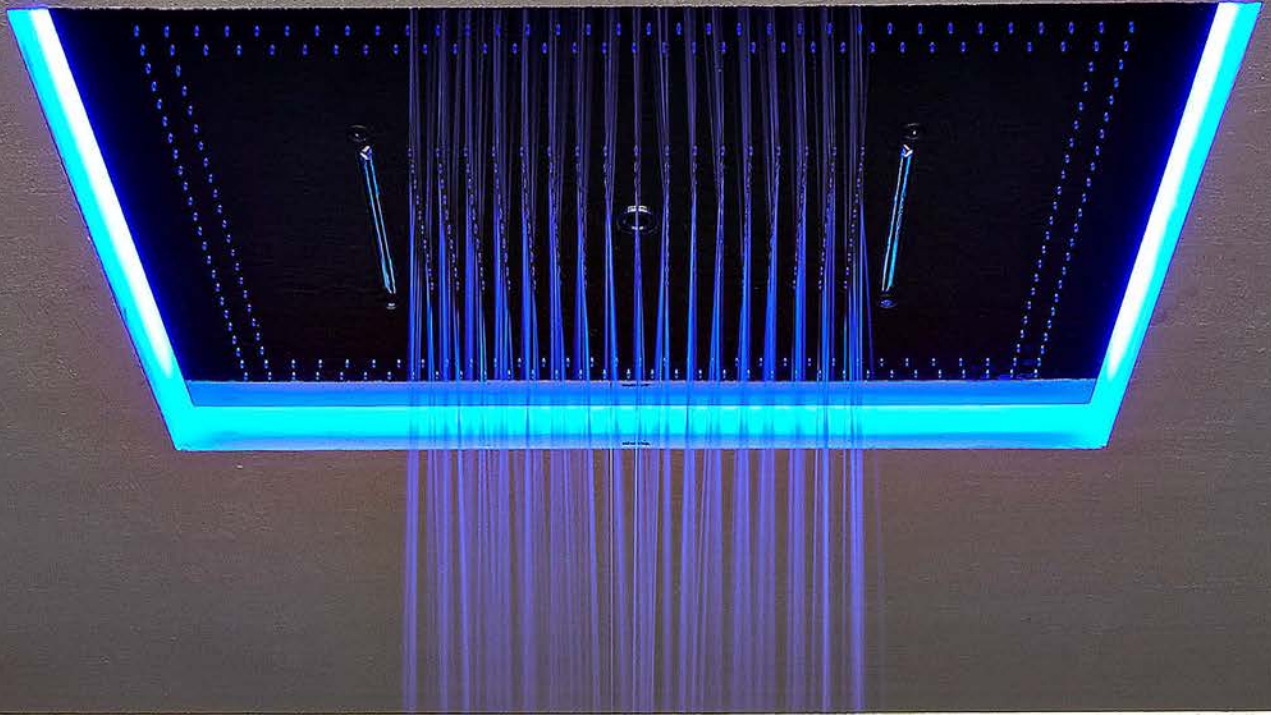

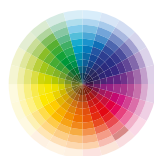

Tutti i soffioni con illuminazione a LED RGB sono dotati di telecomando waterproof IP66 che può essere utilizzato comodamente sotto la doccia.

*All overhead showers with RGB LED lighting come with an IP66 waterproof remote control that can easily be used under the shower.*



H	P	L	art.
11	75	100	METEOXXL

Soffione ad incasso a soffitto in acciaio AISI 304 con doccia centrale e perimetrale, doppia cascata, getto a chiodo, nebulizzatori e possibile illuminazione a LED RGB comprensiva di telecomando waterproof.

N.B. Necessita di deviatore a cinque vie.

*Ceiling encased showerhead in stainless steel AISI 304 with central and perimeter shower, double waterfall, hard center jet, nebulizers and possible LED RGB lighting complete with waterproof remote.*

*P.S. Requires five way diverter.*

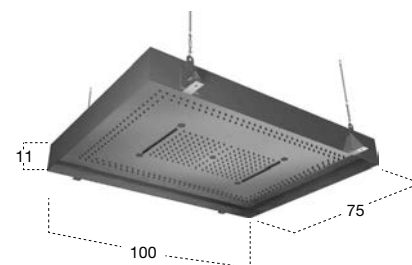

METE03C



doccia centrale  
*central shower*



cascata  
*waterfall*



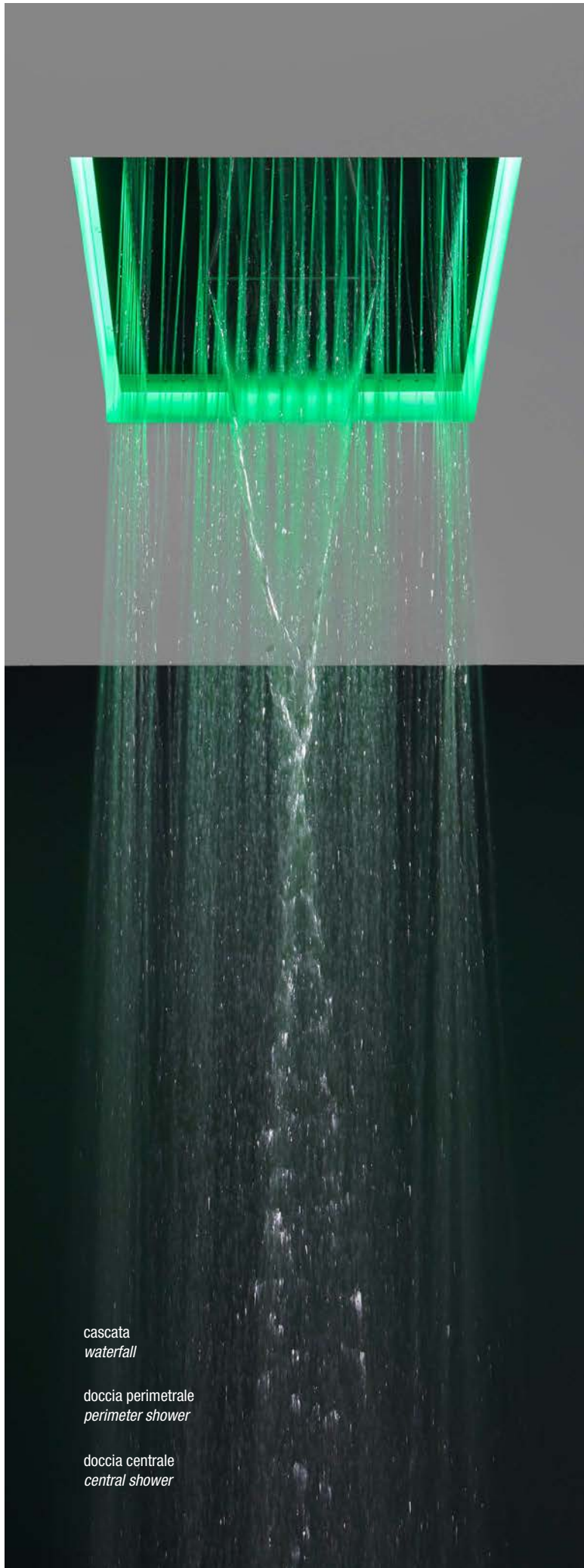

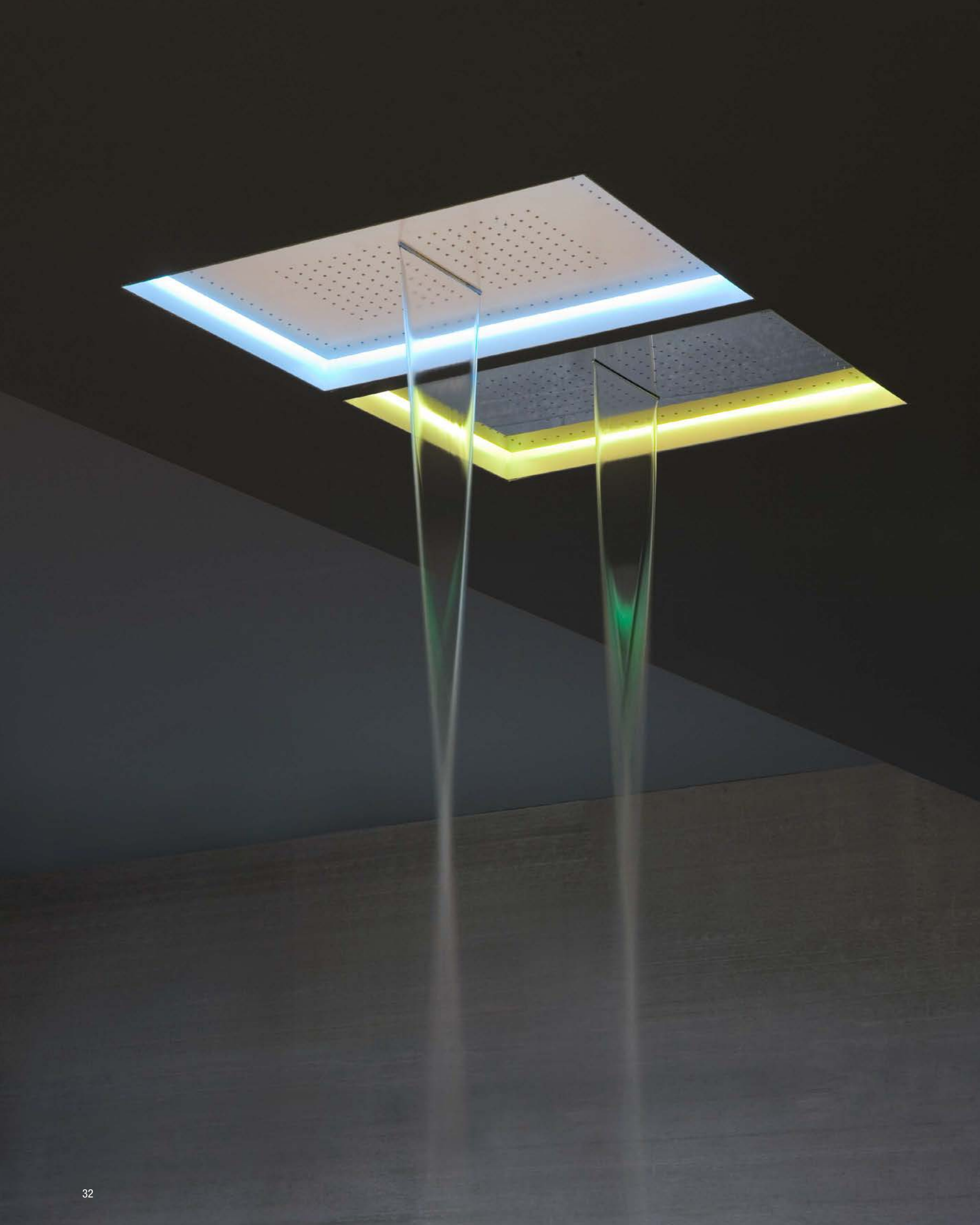

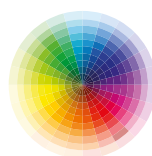

Tutti i soffioni con illuminazione a LED RGB sono dotati di telecomando waterproof IP66 che può essere utilizzato comodamente sotto la doccia.



All overhead showers with RGB LED lighting come with an IP66 waterproof remote control that can easily be used under the shower.

H	P	L	art.
11	52	75	METE03C

Soffione ad incasso a soffitto in acciaio AISI 304 con doccia centrale e perimetrale, cascata e possibile illuminazione a LED RGB comprensiva di telecomando waterproof.  
N.B. Necessita di deviatore a tre vie.

*Ceiling encased showerhead in stainless steel AISI 304 with central and perimeter shower, waterfall and possible RGB LED lighting and waterproof remote.  
P.S. Requires three way diverter.*

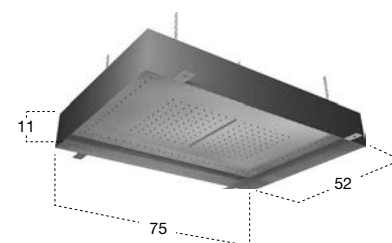

METEO

COME SE CI FOSSE UN ARCOBALENO  
*AS IF THERE WERE A RAINBOW*

Tonificante: colori caldi dal giallo al rosso fino al verde  
Rilassante: dal blu al verde neutrale  
Energizzante: rosso, giallo, seguiti dal verde e dal bianco

*Invigorating: warm colors from yellow to red up to green*  
*Relaxing: from blue to neutral green*  
*Energizing: red, yellow, followed by green and white*

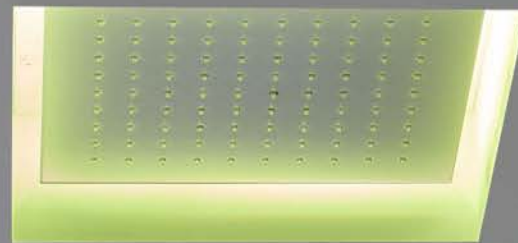
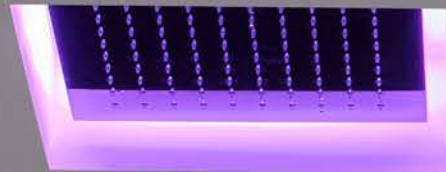
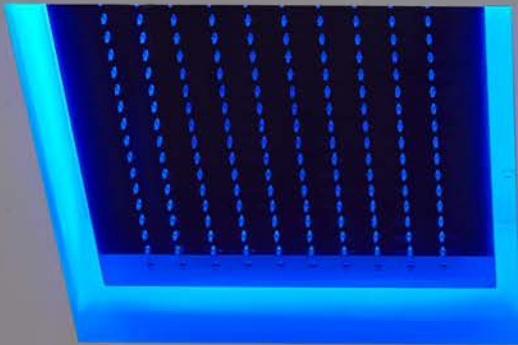
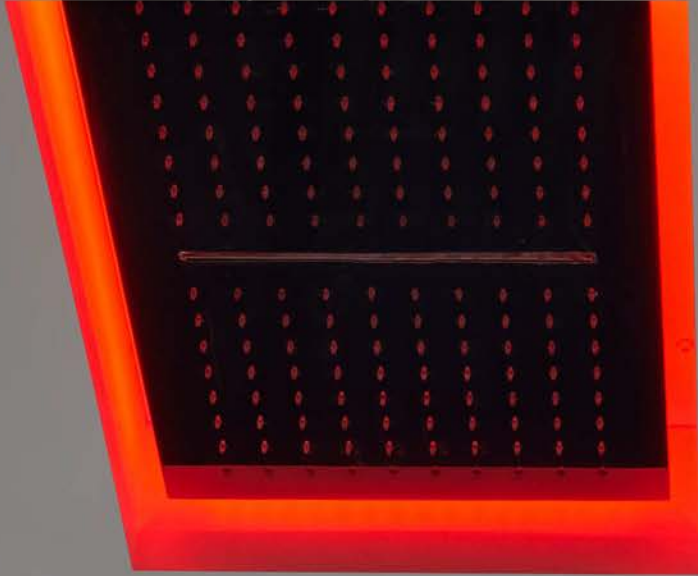



doccia centrale  
central shower

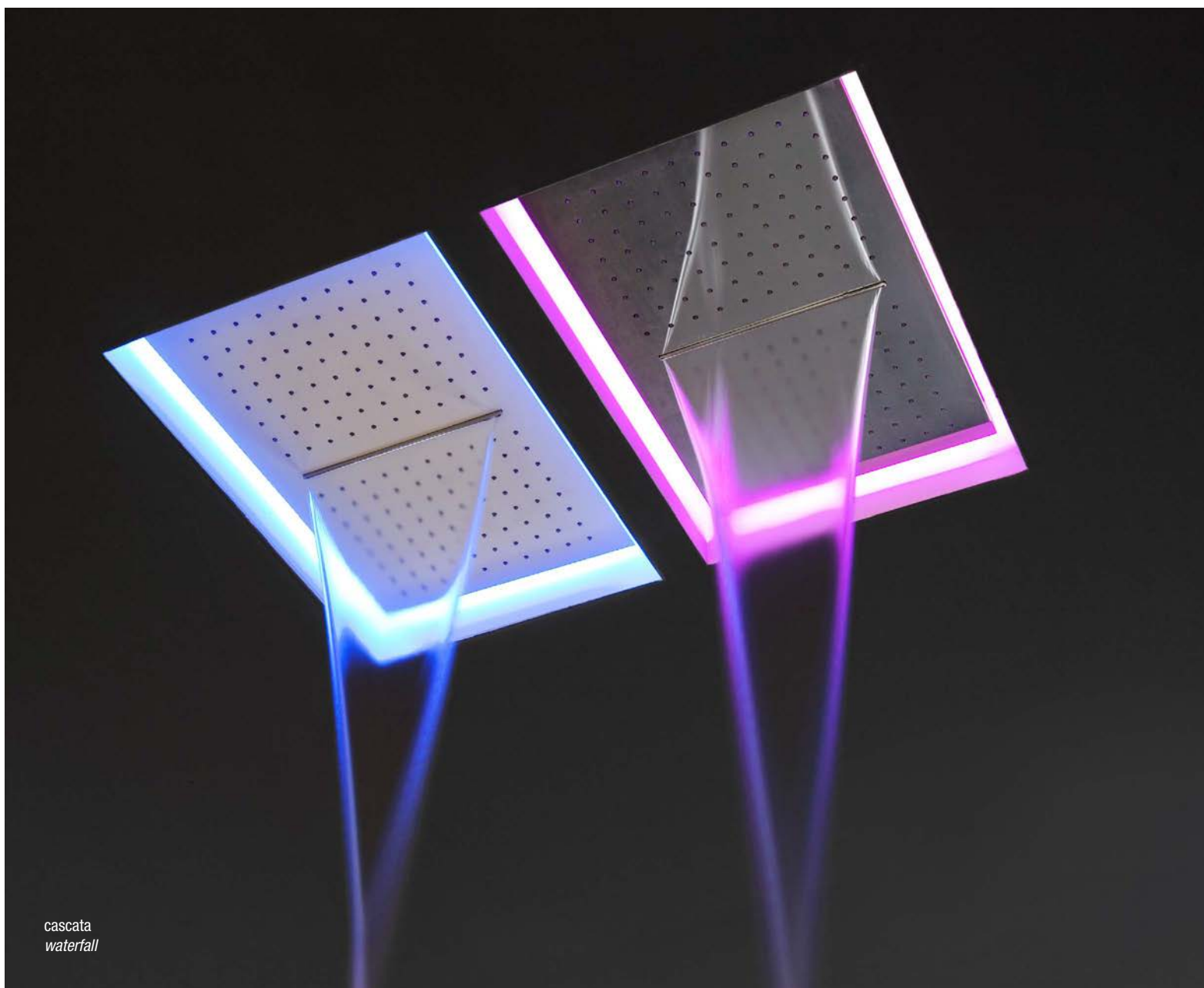

cascata  
waterfall

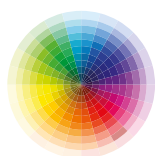

Tutti i soffioni con illuminazione a LED RGB sono dotati di telecomando waterproof IP66 che può essere utilizzato comodamente sotto la doccia.



All overhead showers with RGB LED lighting come with an IP66 waterproof remote control that can easily be used under the shower.

H	P	L	art.
11	35	52	METE02C

Soffione ad incasso a soffitto in acciaio AISI 304 con doccia centrale e cascata, disponibile in diverse finiture, con possibile illuminazione a LED RGB comprensiva di telecomando waterproof.

N.B. Necessita di deviatore a due vie.

*Ceiling encased showerhead in stainless steel AISI 304 with central shower and waterfall, available in various finishes, with possible RGB LED lighting and waterproof remote.  
P.S. Requires two way diverter.*

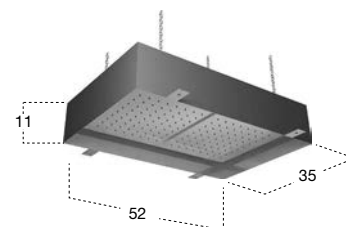

METE01

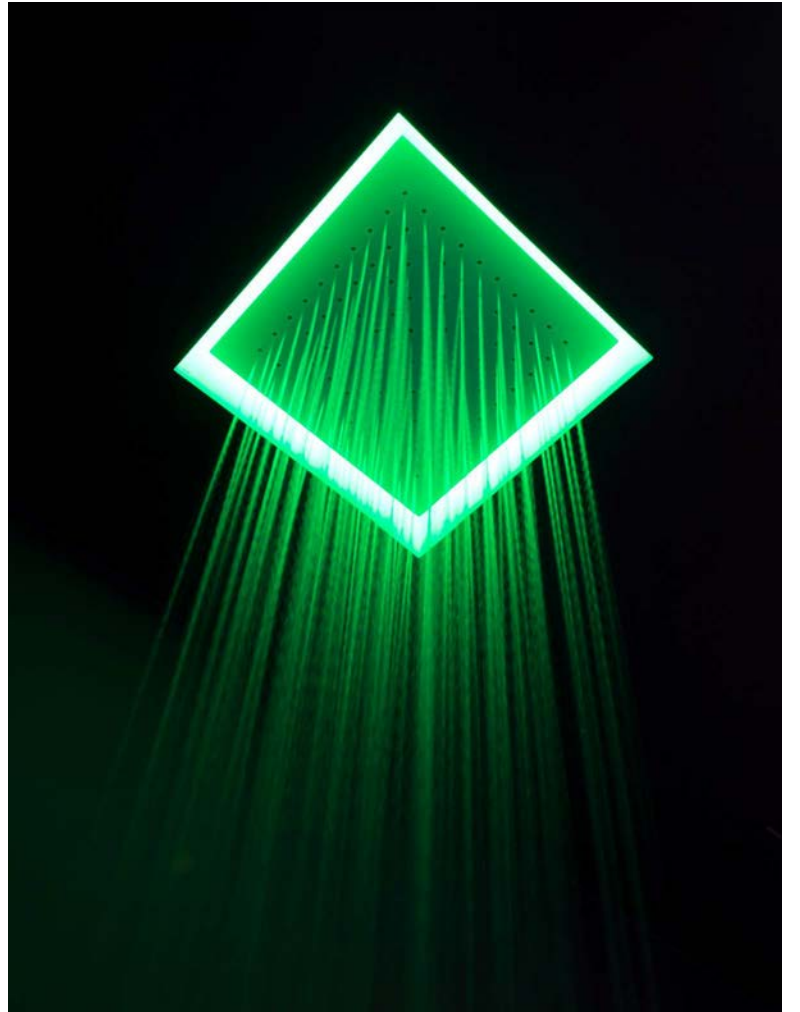
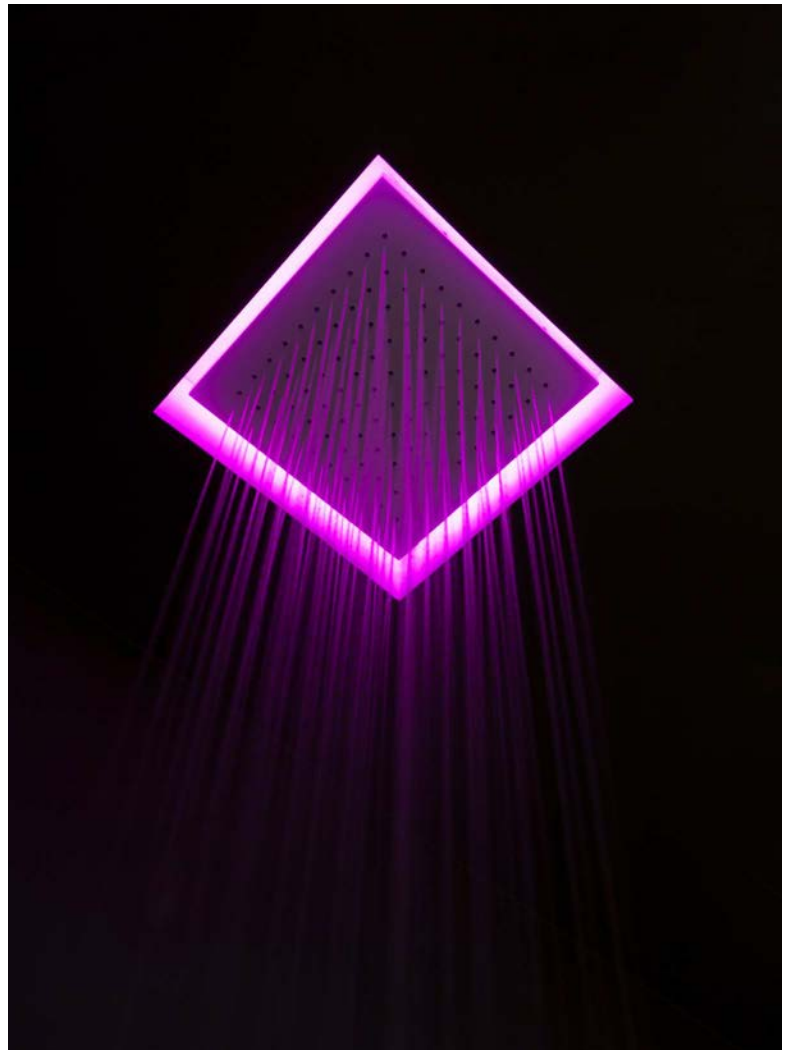



METE02

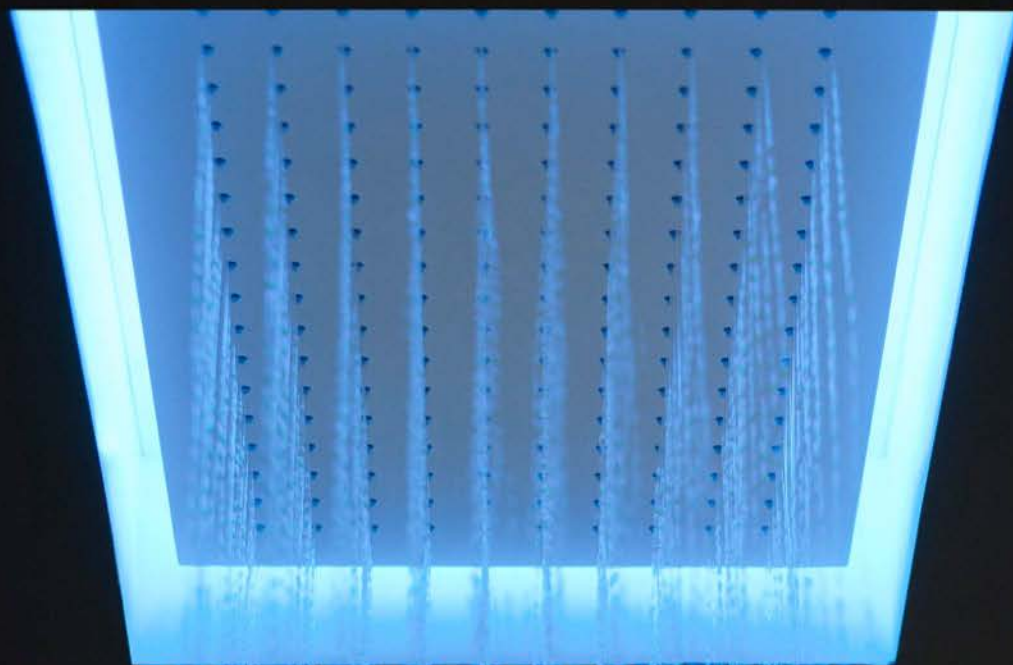

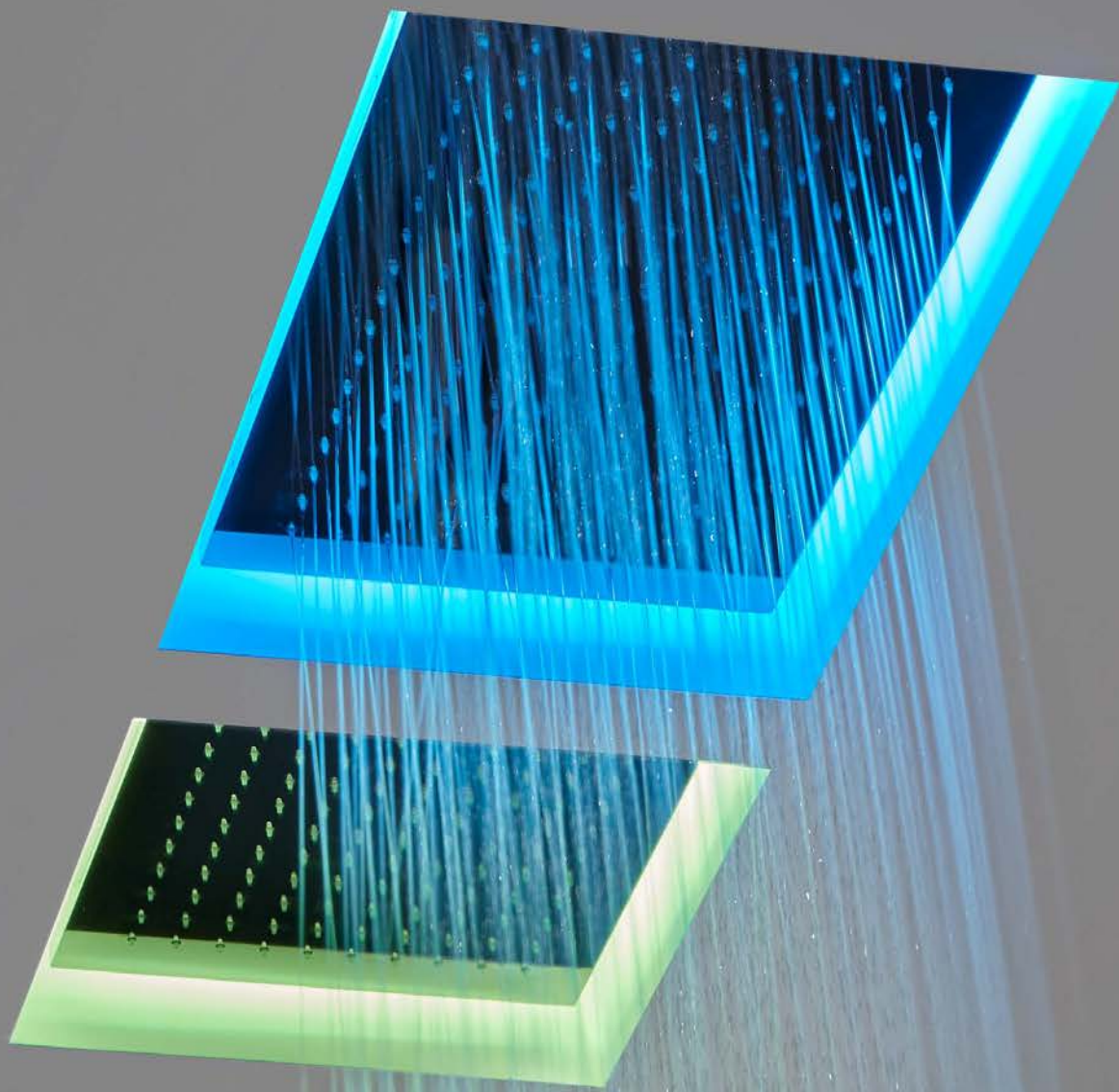

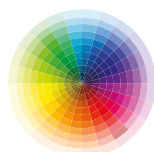
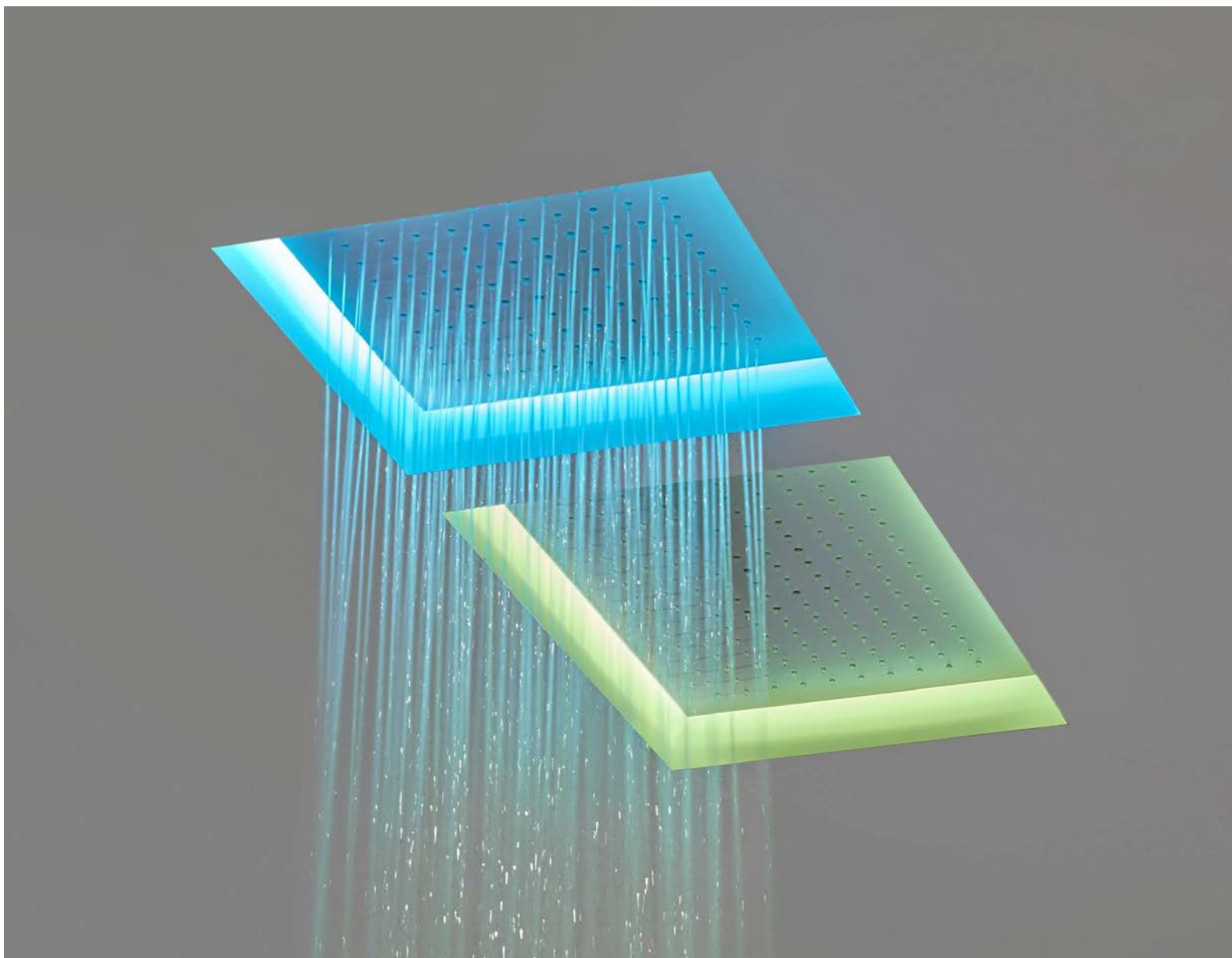

Tutti i soffioni con illuminazione a LED RGB sono dotati di telecomando waterproof IP66 che può essere utilizzato comodamente sotto la doccia.



*All overhead showers with RGB LED lighting come with an IP66 waterproof remote control that can easily be used under the shower.*

Art. METE01

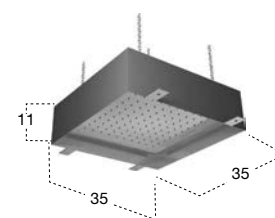

Art. METE02

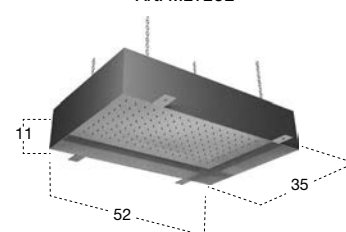

H	P	L	art.
11	35	35	METE01
11	35	52	METE02

Soffione ad incasso a soffitto in acciaio AISI 304, disponibile in diverse finiture, con possibile illuminazione a LED RGB comprensiva di telecomando waterproof.

*Ceiling encased showerhead in stainless steel AISI 304 available in various finishes, with possible RGB LED lighting and waterproof remote.*

METEO





11



12



13



14



15



16



17



18



19



20

# FUORIMETEO SLIM

\_2011

design  
Nevio  
Tellatin

Modello e design registrato, brevetto depositato  
*Registered model and design, patent filed*

Quando l'incasso non è possibile, c'è FUORIMETEO SLIM, soli 9 cm dal soffitto, bianco o verniciabile a contrasto o nello stesso colore delle pareti.

*When encasing is not possible consider FUORIMETEO SLIM, only 9 cm H, white or paintable in a contrasting or same color as the ceiling.*







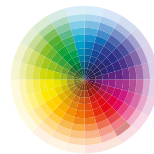

Tutti i soffioni con illuminazione a LED RGB sono dotati di telecomando waterproof IP66 che può essere utilizzato comodamente sotto la doccia.



*All overhead showers with RGB LED lighting come with an IP66 waterproof remote control that can easily be used under the shower.*

H	P	L	art.
9	35	35	FMS10

Soffione a soffitto con struttura esterna in acciaio AISI 304, disponibile in diverse finiture, con possibile illuminazione a LED RGB comprensiva di telecomando waterproof.

*Ceiling mounted showerhead with external frame in steel AISI 304 available in various finishes, with possible RGB LED lighting and waterproof remote.*

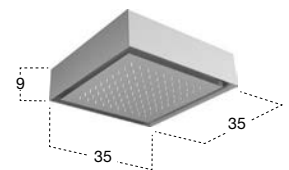

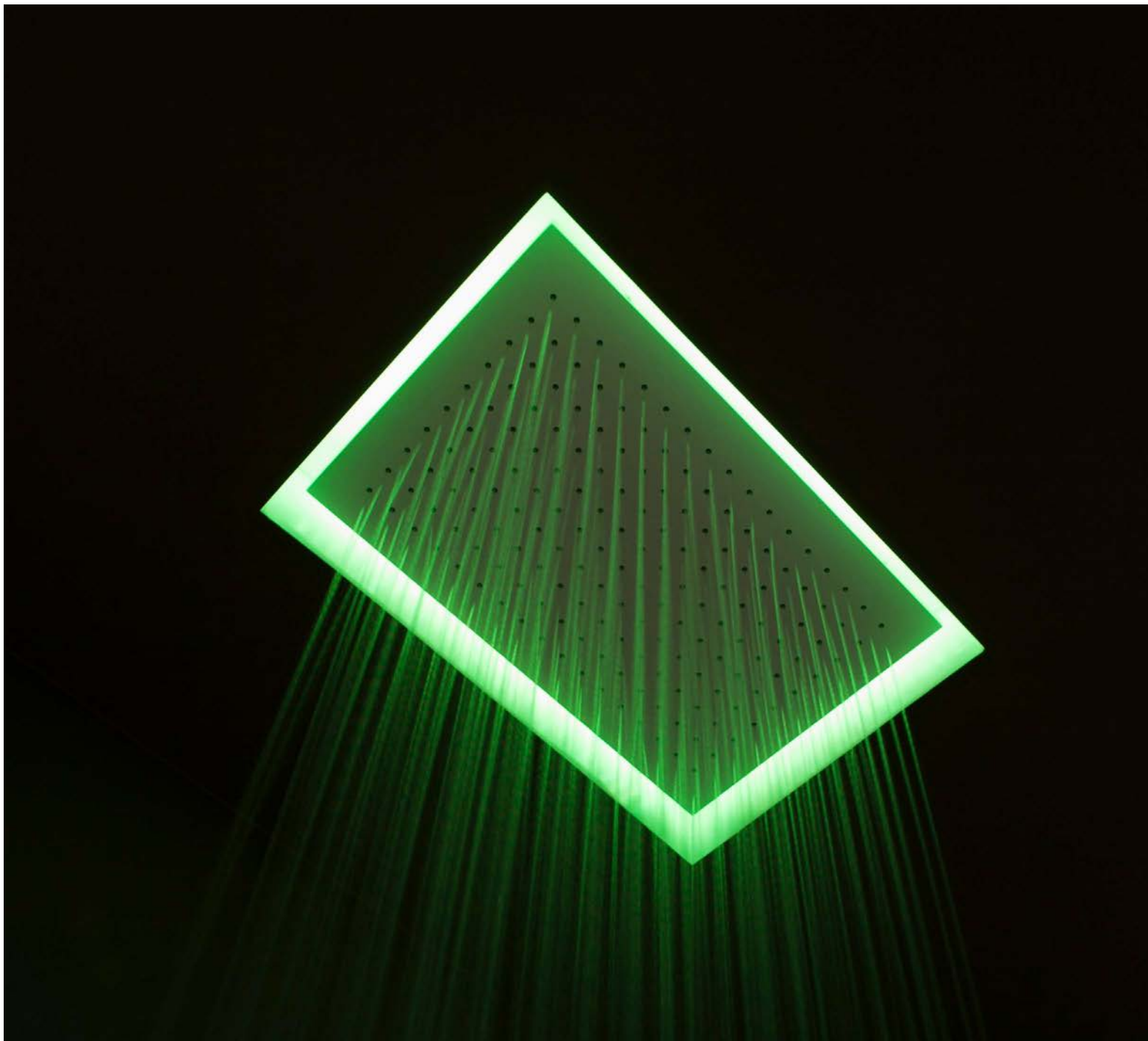

Tutti i soffioni con illuminazione a LED RGB sono dotati di telecomando waterproof IP66 che può essere utilizzato comodamente sotto la doccia.

*All overhead showers with RGB LED lighting come with an IP66 waterproof remote control that can easily be used under the shower.*

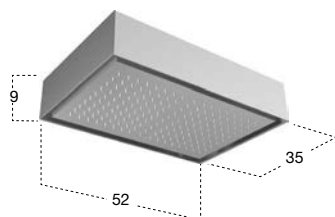

H	P	L	art.
9	35	52	FMS20

Soffione a soffitto con struttura esterna in acciaio AISI 304, disponibile in diverse finiture, con possibile illuminazione a LED RGB comprensiva di telecomando waterproof.

*Ceiling mounted showerhead with external frame in steel AISI 304 available in various finishes, with possible RGB LED lighting and waterproof remote.*

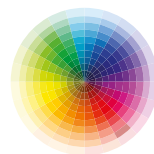
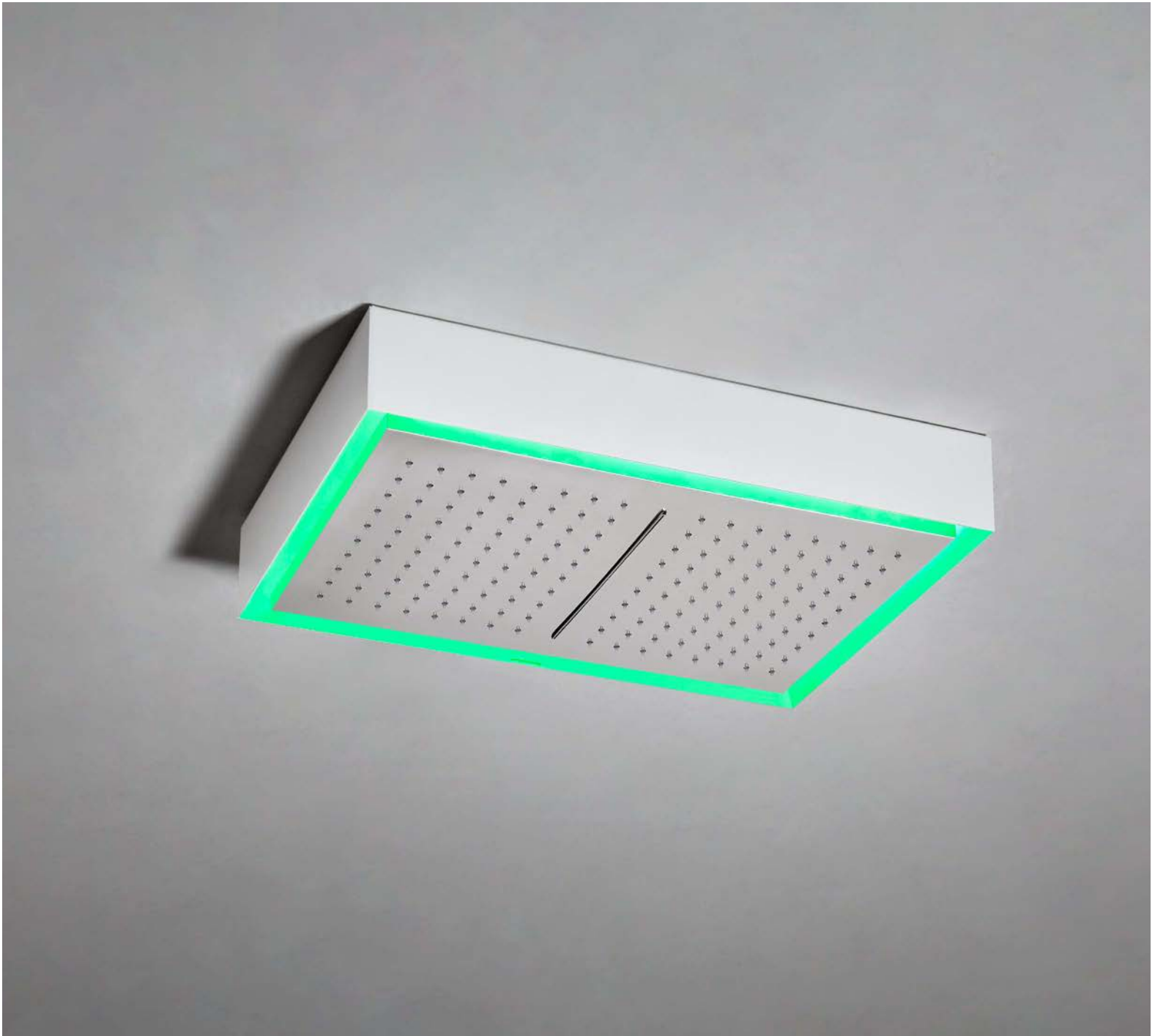

Tutti i soffioni con illuminazione a LED RGB sono dotati di telecomando waterproof IP66 che può essere utilizzato comodamente sotto la doccia.



All overhead showers with RGB LED lighting come with an IP66 waterproof remote control that can easily be used under the shower.

H	P	L	art.
9	35	52	FMS20C

Soffione a soffitto con doccia centrale, cascata e struttura esterna in acciaio AISI 304, disponibile in diverse finiture, con possibile illuminazione a LED RGB comprensiva di telecomando waterproof.

N.B. Necessita di deviatore a due vie.

*Ceiling mounted showerhead with central shower, waterfall and external frame in steel AISI 304, available in various finishes, with possible RGB LED lighting and waterproof remote. P.S. Requires two way diverter.*

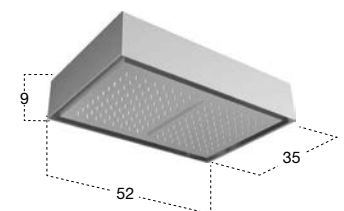

# LAMATTONELLA

\_2014

design  
Nevio  
Tellatin

UN MODULO QUADRATO IN ACCIAIO INOX LUCIDO  
*A SQUARE MODULE IN POLISHED STAINLESS STEEL*

Semplicemente con una nicchia nel cartongesso si può ottenere un binario che ospita gli elementi desiderati: la cascata, la pioggia, la pioggia con il chiodo, nella sequenza voluta, in modo da creare uno straordinario unico soffione.

*With a simple niche in the plasterboard you can obtain a track to house the desired elements: waterfall, rainfall, rainfall with nail jet, in the desired sequence so as to create an extraordinary and unique showerhead.*



## LAMATTONELLA

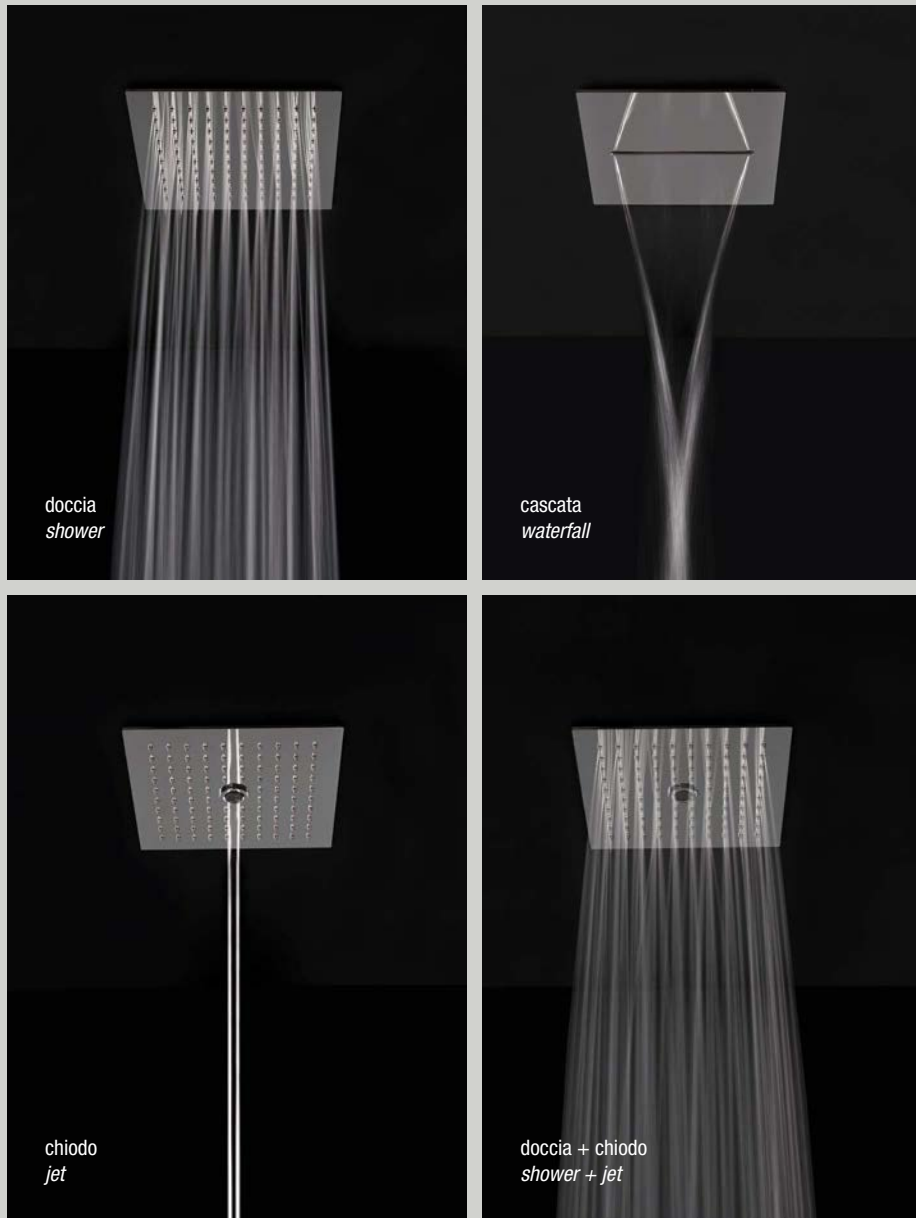

Un modulo quadrato: LAMATTONELLA appunto. Realizzato in acciaio inox lucido, ciascun soffione, in grado di erogare acqua con effetto pioggia o attraverso un getto a cascata, viene accostato liberamente agli altri, assolutamente identici per forma e dimensione. Integrati al soffitto i moduli, dallo spessore molto contenuto, vengono posizionati liberamente generando una griglia personalizzata, dando vita a una superficie piastrellata dalla quale l'acqua fuoriesce in maniera molto più naturale, alternando getti e posizioni. Un sistema elegante e funzionale, che si avvale di un particolare aggancio alla base fissata al soffitto che ne facilita l'installazione e la rimozione.

*A completely new concept, a project that allows you to break down the individual functions of the showerhead allowing to create new wellness paths. A square module: LAMATTONELLA. Made of polished stainless steel, each showerhead with a single function, rainfall, cascade or single jet that can be placed side by side because identical in shape and size. Integrated in the ceiling with a minimal thickness can be positioned freely creating a tiled surface effect from which water flows. An elegant and functional system which makes use of a particular coupling system to the base and fixed to the ceiling facilitating installation removal.*



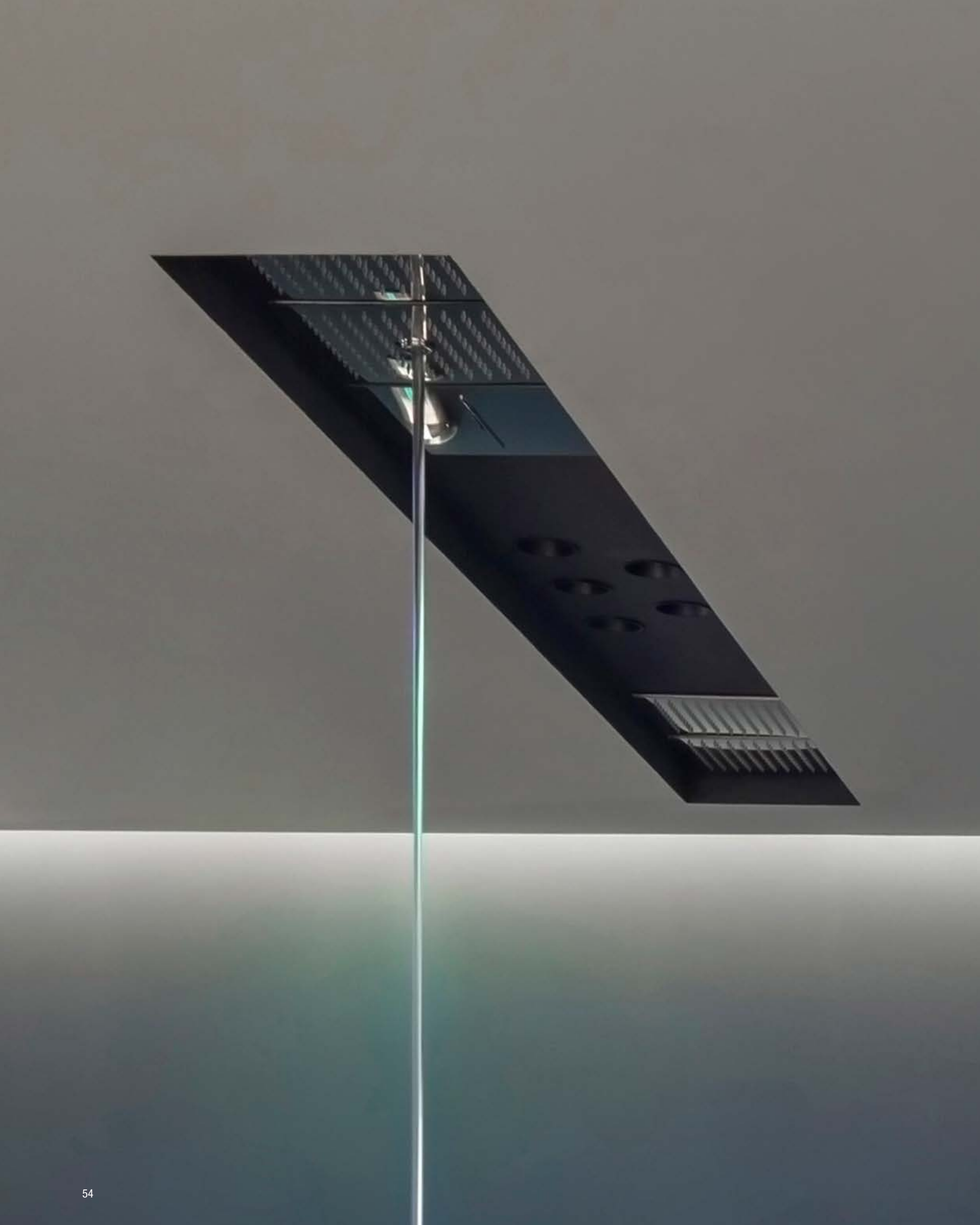





H	P	L	art.
0,5	25	25	LMN1_A
0,5	25	25	LMN2_A
0,5	25	25	LMN3_A

**Art. LMN1\_A**

Soffione modulare ad incasso a soffitto in acciaio inox lucido AISI 304.

*Ceiling encased modular showerhead in polished stainless steel AISI 304.*

**Art. LMN2\_A**

Soffione modulare ad incasso a soffitto con getto a chiodo in acciaio inox lucido AISI 304.

N.B. Necessita di deviatore a due vie.

*Ceiling encased modular showerhead with hard center jet in polished stainless steel AISI 304.*

*P.S. Requires two way diverter.*

**Art. LMN3\_A**

Soffione modulare ad incasso a soffitto con cascata in acciaio inox lucido AISI 304.

*Ceiling encased modular showerhead with waterfall in polished stainless steel AISI 304.*

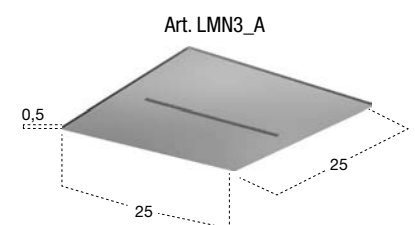
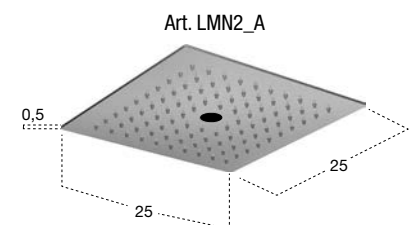
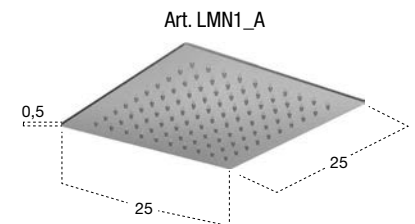

# ZENIT

\_2018

design  
AL Studio

Una fonte che scompare nel soffitto annullandosi. Ruota attorno al tema dell'assenza il progetto ZENIT10, il soffione che si nasconde per lasciare all'acqua il ruolo di assoluta protagonista. Le dimensioni contenute determinano un getto concentrato e intenso, l'assenza di elementi visibili facilita l'inserimento in qualsiasi contesto di stile. Perfetto per inserirsi in ambienti minimali e contemporanei, ZENIT10 si manifesta unicamente quando è in funzione, generando una sorgente di benessere apparentemente nascosta.

Privo di telaio visibile il soffione appare come un semplice foro nel controsoffitto e rimanda in maniera esplicita all'immagine di altri elementi, proponendo un radicale cambio di significato e di funzione. L'origine di ZENIT10 è infatti quella di un corpo illuminante da incasso pensato appositamente per il bagno, con la possibilità di essere collocato anche all'interno dello spazio doccia grazie alle specifiche caratteristiche tecniche. Partendo quindi dalla stessa struttura di incasso è bastato sostituire il faretto con il soffione per dare vita a uno strumento di benessere in pochissimo spazio.

*A source that disappears in the ceiling. The ZENIT10 project revolves around the theme of absence, the overhead shower hides to leave the role of absolute protagonist to water. The small dimensions determine a concentrated and intense jet, the absence of visible elements facilitates the insertion in any context or style. Perfect to fit in minimal and contemporary settings, ZENIT10 manifests itself only when it is operating, generating a source of hidden well-being.*

*Without a visible frame, the overhead shower appears as a simple hole in the false ceiling and refers explicitly to the image of other elements, proposing a radical change in meaning and function. The origin of ZENIT10 is in fact that of a recessed lighting fixture designed specifically for the bathroom, with the possibility of being placed inside the shower space thanks to the specific technical characteristics. Starting from the same recessed structure it was enough to replace the spotlight with the showerhead to give life to a tool of well-being in very little space.*







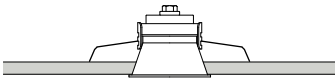

	H	Ø	art.
	6	8	ZENIT10
	6	8	ZENIT11
	10	8	ZENITLED

**Art. ZENIT10**

Soffione in Delrin nero con struttura ad incasso a soffitto in alluminio nero.

*Black Delrin shower with ceiling encasing structure in black aluminum.*

**Art. ZENIT11**

Soffione in Delrin nero con struttura ad incasso a soffitto in alluminio nero con getto a chiodo.

*Black Delrin shower with ceiling encasing structure in black aluminum and nail jet.*

**Art. ZENITLED**

Lampada con struttura ad incasso a soffitto in alluminio nero e illuminazione a led.

*Lamp with ceiling encasing structure in black aluminum and led lighting.*

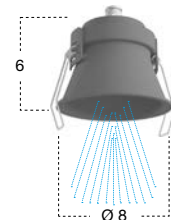
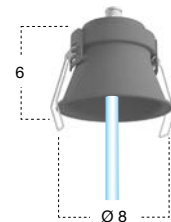
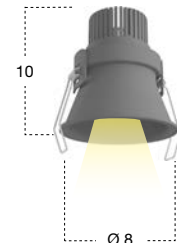
**Art. ZENIT10****Art. ZENIT11****Art. ZENITLED**

# LUMEN

\_2017

design  
Marco  
Pisati

Acqua e colore  
*Water and color*

Un sole che illumina  
*A sun that shines*

Acqua e colore, benessere e relax per il corpo e per la mente. Un sole che illumina, una luce che attrae e cattura lo sguardo, un satellite che orbita nello spazio. Lumen è il soffione caratterizzato da un nucleo centrale colorato attorno al quale si dispongono gli ugelli ospitati da una calotta emisferica dal quale esce un getto speciale nella quale l'acqua converge verso il centro, come attirata da un "campo magnetico" ma in realtà direzionata dall'orientamento del getto.

Il relax garantito da Lumen combina il benessere dell'acqua agli effetti della cromoterapia, l'immagine del soffione in funzione caratterizza l'ambiente bagno donandogli una sofisticata eleganza e un'aura di magia. Acceso diventa il fulcro dello spazio, spento, scompare alla vista. La sua perfetta geometria disegna un anello sottile, un cerchio nel soffitto all'interno del quale pulsa un cuore di luce.

*Water and color, well-being and relaxation for body and mind. A sun that shines, a light that attracts and catches the eye, a satellite that orbits in space. Lumen is the overhead shower characterized by a colored central nucleus around which nozzles are arranged. All hosted by a hemispherical shell from which a special jet of water converges towards the center, as if attracted by a "magnetic field" but actually directed from the orientation of the jet.*

*Lumen guarantees a certain relaxation by combining water with the effects of chromo-therapy. The image of the overhead shower in function gives the bathroom a sophisticated elegance and an aura of magic. When lit, it becomes the fulcrum of space, when off, disappears from sight. It's perfect geometry draws a thin ring, a circle in the ceiling in which a heart of light pulsates.*







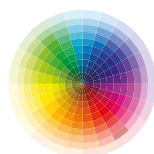
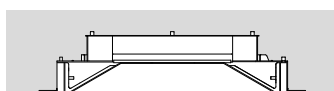

Tutti i soffioni con illuminazione a LED RGB sono dotati di telecomando waterproof IP66 che può essere utilizzato comodamente sotto la doccia.



*All overhead showers with RGB LED lighting come with an IP66 waterproof remote control that can easily be used under the shower.*

H	P	L	art.
12	54	54	LUMEN

Struttura ad incasso a soffitto in acciaio AISI 304 verniciato bianco con illuminazione a LED RGB comprensivo di telecomando waterproof.

*Ceiling encased structure in AISI 304 lacquered white with LED RGB lighting complete with waterproof remote control.*

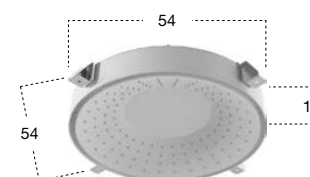

# METEO\_OUT / METEO\_IN

\_2014

design  
Nevio  
Tellatin

Modello e design registrato, brevetto depositato  
*Registered model and design, patent filed*



## METEO\_OUT

Un volume morbido e organico, dall'immagine naturale, un "cratere buono" dal quale fuoriesce un'esplosione di benessere, uno spazio scavato dalla perfetta geometria circolare che si integra perfettamente nel soffitto e senza soluzione di continuità si apre nella superficie per sprigionare il massimo relax: Meteo\_Out è un nuovo soffione che associa alla forza primordiale dell'acqua, i benefici effetti della cromoterapia. Un anello di luce evidenzia infatti la profondità, definisce il luogo da cui fuoriesce l'acqua impreziosendo la superficie e i riflessi metallici del soffione in acciaio inox. Meteo\_Out completa una gamma di soffioni caratterizzati dalla forte componente emozionale che si associa a una tecnologia innovativa. L'illuminazione a LED RGB può essere gestita con telecomando waterproof per dare vita a scenari e sequenze personalizzate, grazie alle quali concepire un benessere su misura.

*A soft, organic volume, natural in shape from which comes out an explosion of wellness, a space carved out from the perfect circular geometry that integrates seamlessly into the ceiling and seamlessly opens the surface to unleash maximum relaxation: Meteo\_Out is a new showerhead that combines the power of water with the beneficial effects of color therapy. A ring of light shows depth and defines from where the water flows out embellishing the surface and the metallic sheen of the showerhead in stainless steel. Meteo\_Out is a complete range of showerheads characterized by a strong emotional component that is associated with innovative technology. The LED RGB lighting can be controlled with the waterproof remote control to create different scenarios as well as customized sequences through which to conceive health made to measure.*



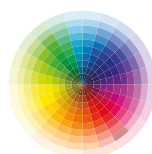
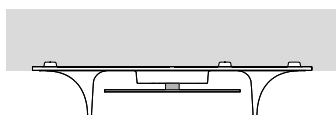
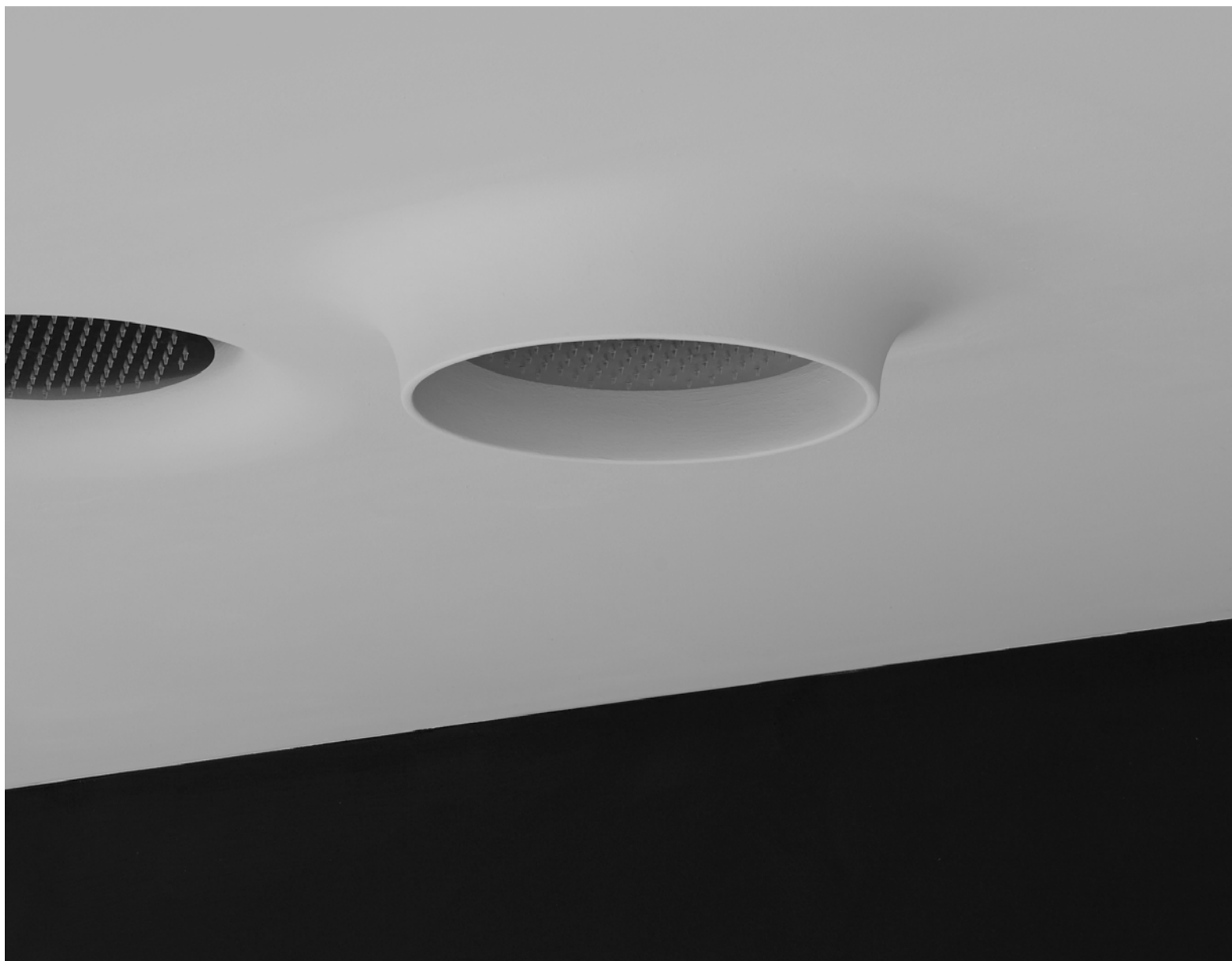

Tutti i soffioni con illuminazione a LED RGB sono dotati di telecomando waterproof IP66 che può essere utilizzato comodamente sotto la doccia.

*All overhead showers with RGB LED lighting come with an IP66 waterproof remote control that can easily be used under the shower.*



H	P	L	art.	art.
10	62	62	METEO_OUT	METEO_OUTL Con illuminazione a led / With led lighting

Struttura ad incasso a soffitto in Flumood con soffione in acciaio inox satinato AISI 304, con possibilità di illuminazione a LED RGB comprensiva di telecomando waterproof.

*Ceiling encased Flumood frame with satin stainless steel AISI 304 showerhead with possible LED RGB lighting complete with waterproof remote control.*

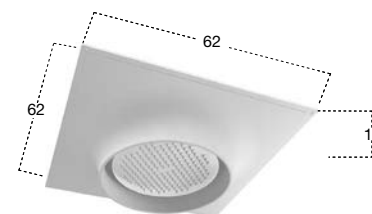

## METEO\_IN

Un satellite in orbita, un corpo celeste circondato da uno sciame di piccoli astri, un disco artificiale che nasconde una pioggia di acqua e luce. L'ultima evoluzione della collezione di soffioni Meteo indaga il tema del mistero, della sorpresa, della capacità della tecnologia di scomparire per lasciare spazio all'emozione. Un disco circolare, perfettamente integrato nel soffitto e avvolto da un anello di luce. Questa è l'immagine del soffione, è la schematizzazione estrema di un concetto, quello dell'integrazione della sorgente nello spazio. L'acqua cade direttamente dal soffitto, la luce colorata ne delimita la proiezione generando un fascio di infinite vibrazioni e riflessi cromatici. La sensazione di benessere è totale e coinvolge tutti i sensi.

*A satellite into orbit, a celestial body surrounded by a swarm of small stars, an artificial disc that hides a shower of water and light. The latest evolution of Meteo shower heads explores the theme of mystery, the surprise of technological skills to disappear and leave space to emotion. A circular disc, perfectly integrated in the ceiling and wrapped by a ring of light. The image of the showerhead, is the integration of the source in space. The water falls directly from the ceiling, colored light delimits the projection generating a beam of infinite vibrations and chromatic reflections. The feeling of wellness is complete, and involves all the senses.*



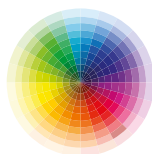
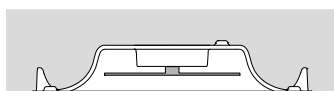

Tutti i soffioni con illuminazione a LED RGB sono dotati di telecomando waterproof IP66 che può essere utilizzato comodamente sotto la doccia.



*All overhead showers with RGB LED lighting come with an IP66 waterproof remote control that can easily be used under the shower.*

H	P	L	art.	art.
11	62	62	METEO_IN	METEO_INL Con illuminazione a led / With led lighting

Struttura ad incasso a soffitto in Flumood con soffione in acciaio inox satinato AISI 304, con possibilità di illuminazione a LED RGB comprensiva di telecomando waterproof.

*Ceiling encased Flumood frame with satin stainless steel AISI 304 showerhead with possible LED RGB lighting complete with waterproof remote control.*

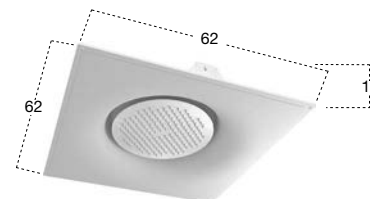





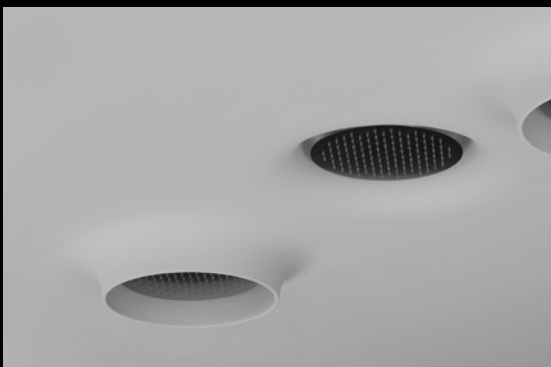

# VELA

\_2015

design  
AL Studio





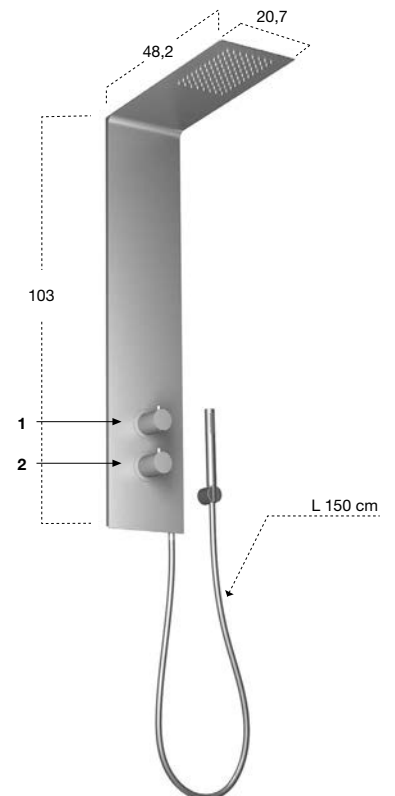

H	P	L	art.
103	48,2	20,7	VELA

Colonna doccia a parete in acciaio inox satinato AISI 304, completa di soffione, miscelatore termostatico (2), rubinetto di comando con deviatore a due vie (1) e doccetta con flessibile 150 cm.

*Showerhead column in AISI 304 satin stainless steel complete with thermostatic mixer (2), command handle with 2-way diverter (1) and hand shower with hose 150 cm.*



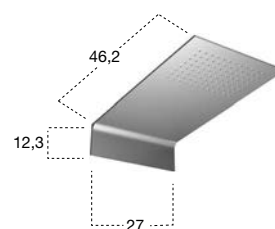

H	P	L	art.
12,3	46,2	27	MEZZAVELA

Soffione a parete in acciaio inox satinato AISI 304.

*AISI 304 satin stainless steel wall mounted showerhead.*







H	P	L	art.	
0,2	50,3	20,7	LASTRA	Acciaio Satinato / <i>Satin Stainless Steel</i>
0,2	50,3	20,7	LASTRALU	Acciaio Lucido / <i>Polished Stainless Steel</i>
0,2	50,3	20,7	BILASTRA	Acciaio Satinato / <i>Satin Stainless Steel</i>
0,2	50,3	20,7	BILASTRALU	Acciaio Lucido / <i>Polished Stainless Steel</i>

**Art. LASTRA / LASTRALU**

Soffione a parete in acciaio inox AISI 304 satinato o lucido.

*Wall mounted showerhead in satin or polished stainless steel AISI 304.*

**Art. BILASTRA / BILASTRALU**

Soffione a parete con cascata in acciaio inox AISI 304 satinato o lucido.

N.B. Necessita di deviatore a due vie.

*Wall mounted waterfall showerhead in satin or polished stainless steel AISI 304.*

*P.S. Requires two way diverter.*

Art. LASTRA / LASTRALU

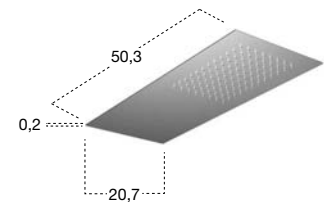

Art. BILASTRA / BILASTRALU

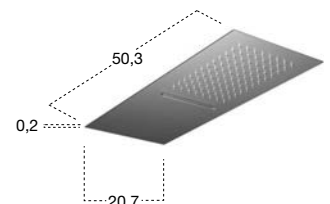



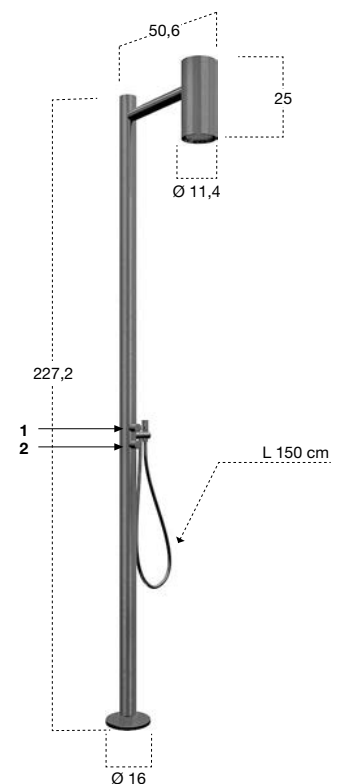

H	P	Ø	art.
227,2	50,6	11,4	SHAWA2

Colonna doccia da terra per interno o esterno, in acciaio inox satinato AISI 316/L, completa di corpo ad incasso, soffione, miscelatore (2), rubinetto di comando con deviatore a due vie (1) e doccetta con flessibile 150 cm.

*Freestanding shower for internal and external use, in satin stainless steel AISI 316/L complete with concealed valve, overhead shower, mixer (2), command handle with two way diverter (1) and hand shower with hose 150 cm.*



# RUBINETTERIA *TAPS*

# MAYDAY

\_2017

design  
GI-RA

Modello e design registrato, brevetto depositato  
*Registered model and design, patent filed*

Ironico nel suo sembrare altro, divertente per la modalità smart di funzionamento, accattivante nel dare un tocco di colore ad ogni spazio doccia, invitante perché se è vero che nell'immaginario collettivo è un pulsante di emergenza da utilizzare solo in caso di estrema necessità, quante volte siamo stati tentati dal premerlo per vedere cosa in realtà sarebbe successo? Gi-RA design presenta un progetto che gioca sul ribaltamento di significato trasformando un pulsante d'emergenza in un comando da utilizzare tutti i giorni, come sottolinea anche il nome: Mayday è un miscelatore monocomando a parete remoto adattabile a più utenze, rubinetto lavabo, soffione, doccetta. Insomma se non si resiste alla voglia di premerlo, si può andare incontro a una sorpresa. Il ribaltamento di significati infatti, diventa ancora più spinto quando si considera il suo funzionamento. L'acqua si apre infatti, grazie a un movimento assiale, non come ci si aspetterebbe premendo il pulsante, ma tirandolo verso di noi. La miscelazione del getto d'acqua avviene ruotando a dx e sx il pulsante mentre, per chiudere il getto basta premerlo. Un modo nuovo di interpretare il miscelatore e ridefinirne caratteri e modalità di funzionamento.

*Ironic in its style and fun for its smart operating mode, attractive in giving a touch of color to any shower space, inviting because it seems like an emergency button to be used only in case of extreme necessity, how many times we were tempted to press one and see what actually would happen? Gi-RA design features a design that plays on meanings transforming an emergency button in a command handle to use every day: Mayday is a remote wall mixer suitable for sink taps, showerheads or hand showers. The water opens by means of an axial movement, not as you would expect by pressing the button but pulling it toward us. The mixing of the water jet takes place by turning right or left while pressing the button closes the jet. A new way of interpreting the mixer and redefining characters and modes of operation.*



verniciato rosso  
*red lacquered*



verniciato bianco  
*white lacquered*



inox satinato  
*satin stainless steel*



grafite  
*graphite*









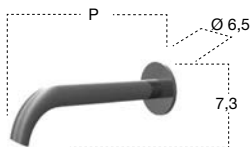
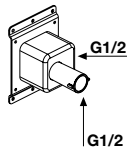

art.

AY921IN

Corpo ad incasso per art. AY920SA, art. AY920LU, art. AY921SA, art. AY921LU, art. AY922SA e art. AY922LU.

*Concealed valve for art. AY920SA, art. AY920LU, art. AY921SA, art. AY921LU art. AY922SA and art. AY922LU.*

H	P	Ø	art.	
7,3	10	6,5	AY920SA	Acciaio Satinato / <i>Satin Stainless Steel</i>
7,3	10	6,5	AY920LU	Acciaio Lucido / <i>Polished Stainless Steel</i>
7,3	19,8	6,5	AY921SA	Acciaio Satinato / <i>Satin Stainless Steel</i>
7,3	19,8	6,5	AY921LU	Acciaio Lucido / <i>Polished Stainless Steel</i>
7,3	25,8	6,5	AY922SA	Acciaio Satinato / <i>Satin Stainless Steel</i>
7,3	25,8	6,5	AY922LU	Acciaio Lucido / <i>Polished Stainless Steel</i>

Erogatore a parete per lavabo, escluso di corpo a incasso.

*Wall mount sink spout, concealed valve not included.*



H	P	Ø	art.
10	12	7,9	MAYDAY

Miscelatore monocomando da incasso a parete in acciaio inox satinato AISI 316/L, con manopola in acciaio inox satinato oppure in ottone finitura grafite, verniciato rosso o bianco completo di corpo ad incasso.

*Single lever wall mixer in satin stainless steel AISI 316/L, with satin stainless steel, red or white lacquered brass handle or graphite, complete with concealed valve.*





inox satinato  
satin stainless steel



H	P	Ø	art.
10	12	7,9	MAYDAY

Miscelatore monocomando da incasso a parete in acciaio inox satinato AISI 316/L, con manopola in acciaio inox satinato oppure in ottone finitura grafite, verniciato rosso o bianco completo di corpo ad incasso.

*Single lever wall mixer in satin stainless steel AISI 316/L, with satin stainless steel, red or white lacquered brass handle or graphite, complete with concealed valve.*

H	P	Ø	art.
7,3	10	6,5	AY410SA

Erogatore da piano per bidet in acciaio satinato AISI 316/L.

*Spout for bidet in satin stainless steel AISI 316/L.*



grafite  
graphite

H	P	Ø	art.
10	12	6	MINIMAYDAY

Miscelatore monocomando da incasso a parete in acciaio inox AISI 316/L, con manopola in acciaio inox satinato oppure in ottone finitura grafite, verniciato rosso o bianco completo di corpo ad incasso.

*Single lever mixer with a satin stainless steel handle or graphite, lacquered red or white brass complete with concealed valve.*

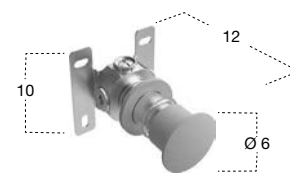

H	P	Ø	art.
4,5	8,4	3	MINIAZIMUT20

Erogatore a parete per lavabo in acciaio inox AISI 304 e Delrin nero, con regolazione del getto, disponibile anche in finitura grafite.

*Wall mount spout for sink in stainless steel AISI 304 and black Delrin, with jet regulation, also available in graphite finish.*

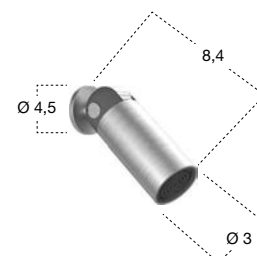

## MINIMAYDAY design GI-RA

Modello e design registrato, brevetto depositato

Registered model and design, patent filed

Dal fratello maggiore ha preso l'immagine ironica e divertente, l'immediatezza del gesto, la capacità di dare gioia e colore allo spazio doccia, pur con dimensioni più contenute. La manopola esterna di MiniMayDay ha infatti un diametro di due centimetri inferiore rispetto a quella di MayDay (6 cm contro 8 cm) ma conserva intatte le caratteristiche del progetto originale. Un miscelatore monocomando a parete remoto adattabile a più utenze, rubinetto lavabo, soffione, doccia, che nasce dal ribaltamento di significato che trasforma un pulsante d'emergenza in un comando da utilizzare tutti i giorni, come sottolinea il nome stesso. Rimane invariata la modalità smart di funzionamento. L'acqua si apre grazie a un movimento assiale, non come ci si aspetterebbe premendo il pulsante ma tirandolo verso di noi. La miscelazione del getto d'acqua avviene ruotandolo a dx e sx il pulsante mentre, per chiudere il getto basta premere il pulsante. Come MayDay anche MiniMayDay propone una finitura in Acciaio Inox Satinato con manopole coordinate nella stessa finitura, oppure in grafite, verniciate rosse o bianche.

*Ironic and funny image taken from its big brother, the outrightness of the gesture, the ability to give joy and color to the shower space even with smaller dimensions. The external knob of MiniMayDay has in fact a diameter of two centimeters less than that of MayDay (6 cm against 8 cm) but retains intact the characteristics of the original design. A single-lever wall-mounted mixer suitable for multiple usage, sink faucet, showerhead, hand shower, which arises from the overturning of the meaning to transform an emergency button into a command handle used every day, as the name underlines. The smart mode of operation remains unchanged. The water opens thanks to an axial movement, not as you would expect by pressing the button but by pulling it towards us. The mixing of the water jet is done by turning the button to the right and left while, to close the jet, just press the button. Like MayDay, MiniMayDay offers a satin stainless steel finish with coordinated knob, or in graphite, lacquered red or white.*

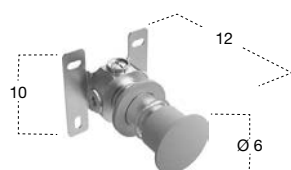

H	P	Ø	art.
10	12	6	MINIMAYDAY

Miscelatore monocomando da incasso a parete in acciaio inox AISI 316/L, con manopola in acciaio inox satinato oppure in ottone finitura grafite, verniciato rosso o bianco completo di corpo ad incasso.

*Single lever mixer with a satin stainless steel handle or graphite, lacquered red or white brass complete with concealed valve.*



verniciato rosso  
*red lacquered*



verniciato bianco  
*white lacquered*



inox satinato  
*satin stainless steel*



grafite  
*graphite*

MINIMAYDAY

art. MINIMAYDAY  
grafite / *graphite*



art. MINIMAYDAYAYD  
inox satinato / *satin stainless steel*



art. FILTRO  
grafite / *graphite*





art. MAYDAY  
verniciato bianco / *white lacquered*



art. MAYDAYAYD  
inox satinato / *satin stainless steel*



art. FILTRO  
inox satinato / *satin stainless steel*







# MAYDAY

\_2017

design

GI-RA

Modello e design registrato, brevetto depositato

*Registered model and design, patent filed*

meccanismo di precisione

*precision mechanism*

deviatore da 2, 3, 4 o 5 vie

*2, 3, 4 or 5 way diverter*



DEVIATORE MAYDAY 5 VIE  
MAYDAY 5 WAYS DIVERTER



Un trasferimento di significato, un'immagine conosciuta che diventa altro acquisendo un nuovo senso, un'esigenza funzionale risolta attraverso un progetto espressivo che diventa simbolo della contemporaneità di antoniolupi. Una soluzione che conferma l'attenzione dell'azienda a combinare aspetto formale e tecnologia, finalizzate a migliorare la qualità della vita dell'uomo. Al MAYDAY, che ha ridefinito l'archetipo del miscelatore trasformando gesti e azioni quotidiane consolidate, è stato aggiunto il deviatore a 5 vie per poter abbinare il miscelatore ai soffioni multifunzionali dell'ampia gamma antoniolupi, decidendo la tipologia del getto e gli scenari wellness possibili. Dal punto di vista formale è l'estetica dell'orologio il riferimento esplicito di questa manopola cilindrica che riporta lungo il perimetro i numeri romani che indicano quale dei diversi getti verrà attivato.

L'eleganza dello stile, la qualità dei materiali e la purezza della forma permettono a Mayday di esaltare qualsiasi contesto di design, impreziosendo lo spazio doccia e facilitandone l'utilizzo.

*A transfer of meaning, a sign that is already known that becomes something else, gaining a new sense, a functional need solved by an expressive project that becomes a symbol of antoniolupi contemporaneity. A new solution that confirms the company's attention to combine design and technology, aimed at improving quality of everyday life. MAYDAY, which has redefined the archetype of mixers by transforming gestures and daily consolidated actions, becomes also a 5 way diverter that can be combined with the wide collection of multifunctional showerheads by antoniolupi. The new 5 way diverter dictates the type of jet and therefore different wellness scenarios. From a design point of view, the shape of a clock is the explicit inspiration of its cylindrical handle showing in roman numbers which of the different jets will be operated.*

*The elegance of style, the quality of materials and a clean design, allow MAYDAY to decorate any shower space with an easy to use system.*



art. MAYDAY  
verniciato bianco / *white lacquered*



art. MAYDAYAYD  
inox satinato / *satin stainless steel*



art. FILTRO  
inox satinato / *satin stainless steel*







H	P	Ø	art.		
9,3	13,8	6	MINIMAYDAYD	Per / For	art. MINIMAYDAY
9,3	13,8	7,9	MAYDAYD	Per / For	art. MAYDAY

Deviatore da 2, 3, 4 o 5 vie, da incasso a parete in acciaio inox satinato AISI 316/L, completo di corpo ad incasso.

*Encased from 2, 3, 4 or 5 way diverter, in satin stainless steel AISI 316/L, complete with concealed valve.*



# FILTRO / FILO

\_2018

design  
GI-RA



La prima è tonda e i fori sulla superficie rimandano immediatamente all'immagine di un filtro, la seconda è un minicilindro, dritto, perfetto, che completa idealmente il tracciato generato dal tubo flessibile. Filtro e Filo sono le nuove doccette grazie alle quali antoniolupi prosegue nel percorso di ridefinizione di questo elemento funzionale. Dopo aver ridisegnato con le precedenti collezioni l'archetipo di questo oggetto, le nuove proposte ne enfatizzano la presenza con eleganza e rigore, integrandolo allo stile di tutti gli accessori. Il flessibile interamente in silicone e disponibile nei colori Nero, Bianco e Grigio, disegna sulla superficie un motivo sinuoso che diventa un "decoro mobile". Dopo l'utilizzo infatti, la doccetta può essere riposizionata in un incastro laterale o in alternativa appoggiata sopra il supporto. Alle valenze estetiche le doccette associano le straordinarie qualità dei materiali utilizzati che conferiscono igienicità e garantiscono un getto potente e preciso.

*The first is round and the holes on the surface immediately refer to the image of a filter, the second is a mini cylinder, straight, perfect, which ideally completes the path generated by the flexible tube. Filter and Filo are the new handshowers thanks to which antoniolupi continues in the path of redefining this functional element. After redesigning the archetype of this object with the previous collections, the new proposals emphasize its presence with elegance and rigor, integrating it with the style of all the accessories. The all-silicone hose, available in Black, White and Grey, draws a sinuous pattern on the surface that becomes a "floating decoration". After use, in fact, the shower can be repositioned in a lateral joint or alternatively resting on the support. To the aesthetic values, the showers combine the extraordinary qualities of the materials used that give cleanliness and guarantee a powerful and precise jet.*



FILTRO



FILO



FILTRO



RUBINETTERIA  
TAPS

FILO



FILTRO

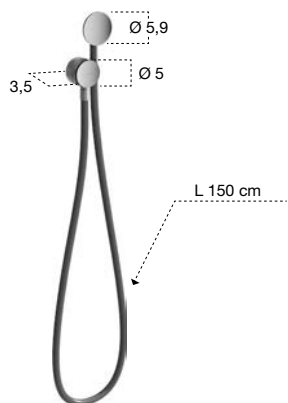

H	P	L	art.
5,9	3,5	5	FILTRO

Doccetta in acciaio inox satinato, lucido o grafite completa di supporto e presa d'acqua a parete con flessibile 150 cm in silicone colorato bianco, nero o grigio.

Hand shower in satin or polished stainless steel or graphite finish complete with wall support and water outlet, flexible hose 150 cm in silicone colored white, black or grey.

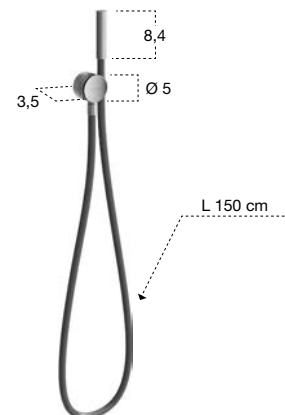

H	P	L	art.
8,4	3,5	5	FIL0

Doccetta in acciaio inox satinato, lucido o grafite completa di supporto e presa d'acqua a parete con flessibile 150 cm in silicone colorato bianco, nero o grigio.

Hand shower in satin or polished stainless steel or graphite finish complete with wall support and water outlet, flexible hose 150 cm in silicone colored white, black or grey.





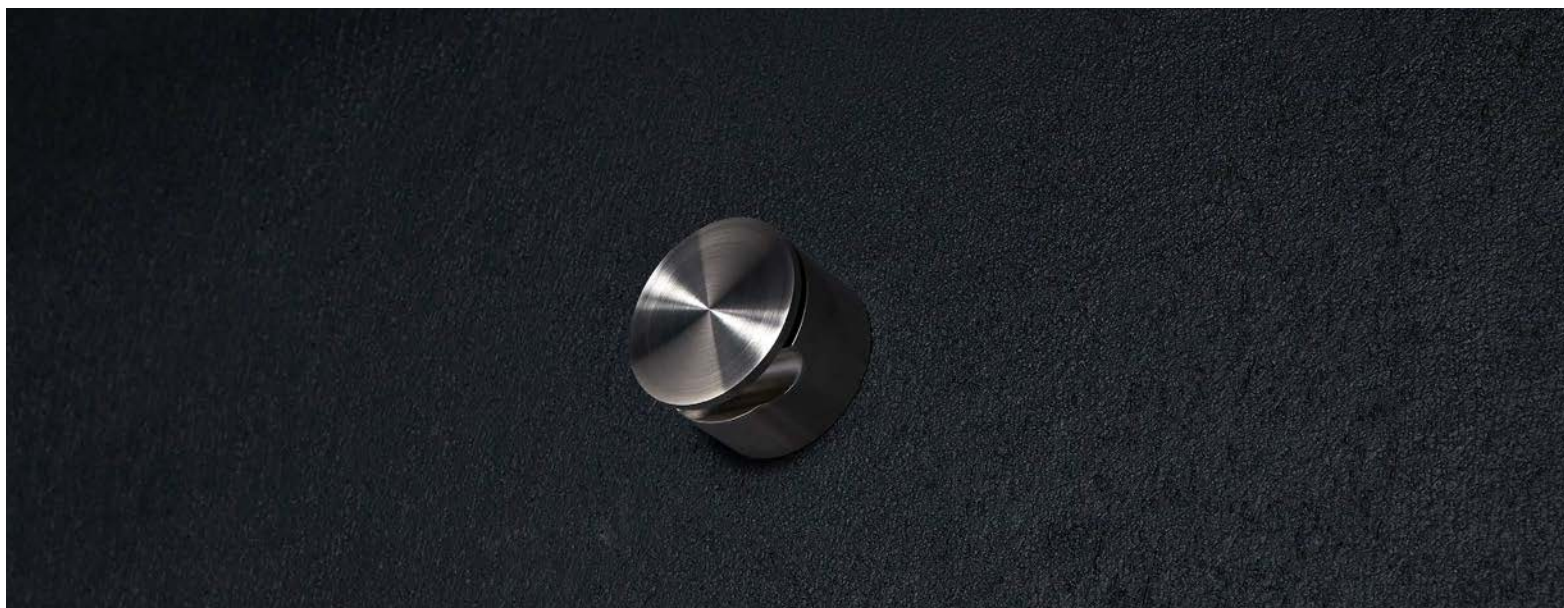

P	Ø	art.
4	6	MOLLA

Supporto a parete in acciaio inox AISI 316/L satinato, lucido o grafite, per doccette Art. FILO e Art. FILTRO.

Wall support in satin stainless steel AISI 316/L, polished or graphite, for handshowers Art. FILO and Art. FILTRO.

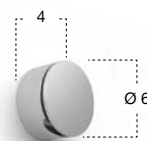



art. TAG1



art. TAG1



art. TAG1



art. TAG2



P	Ø	art.
3,6	6	TAG1

Getto laterale a pioggia da incasso in acciaio inox satinato AISI 304 e Delrin nero.

*Side rain jet to be encased satin stainless steel AISI 304 and black Delrin.*



P	Ø	art.
3,6	6	TAG2

Getto laterale a vela da incasso in acciaio inox satinato AISI 304 e Delrin nero.

*Side veil like jet to be encased satin stainless steel AISI 304 and black Delrin.*

# INDIGO

\_2018

design  
Nevio  
Tellatin

Compatto ma slanciato allo stesso tempo, leggero e dinamico come un piccolo uccello che si posa delicatamente sulla superficie del piano o al contrario stà per spiccare il volo. Come un piccolo colibrì il rubinetto Indigo porta in sé un'energia concentrata in poco spazio, pronta a sprigionarsi una volta aperto il getto d'acqua.

*Compact yet slender, light and dynamic like a small bird that sits gently or on the contrary is about to take flight. Like a small hummingbird, the Indigo tap carries within itself an energy concentrated in a small area, ready to release itself once the water has been opened.*



grafite  
graphite



cromo lucido  
polished chrome



acciaio satinato  
satin steel



INDIGO

1.5 x 1.5 x 1.5  
2019





INDIGO







RUBINETTERIA  
TAPS



INDIGO





RUBINETTERIA  
TAPS





Composizione a 2 vie  
2 way shower set

1. Deviatore 2 vie / 2 way diverter
2. Rubinetto di arresto / Stop valve
3. Miscelatore termostatico / Thermostatic mixer
4. Deviatore 3 vie / 3 way diverter
5. Doccetta Art. FILO / Hand shower Art. FILO
6. Soffione Art.METE01 / Overhead shower Art. METE01



Composizione a 6 vie  
6 way shower set



Composizione a 4 vie  
4 way shower set

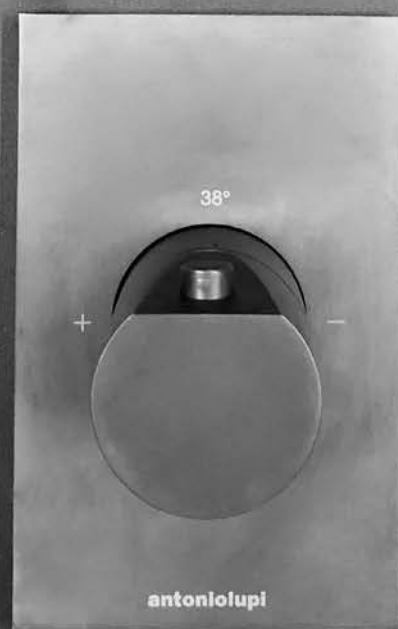
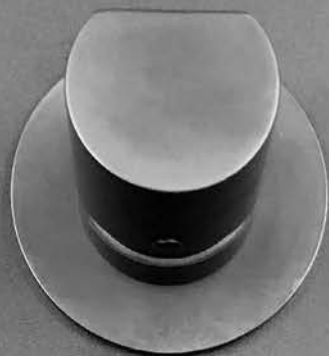

- 2. Rubinetto di arresto / Stop valve
- 3. Miscelatore termostatico / Thermostatic mixer
- 5. Doccetta Art. FILO / Hand shower Art. FILO



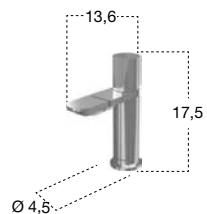

H	P	Ø	art.	
17,5	13,6	4,5	ND400LU	Cromo Lucido / Polished Chrome
	13,6	4,5	ND400SA	Finitura Acciaio Satinato / Satin Steel finish
	13,6	4,5	ND400GR	Grafite / Graphite

Miscelatore monocomando per bidet.

*Single lever mixer for bidet.*

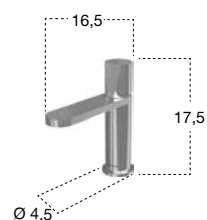

H	P	Ø	art.	
17,5	16,5	4,5	ND301LU	Cromo Lucido / Polished Chrome
	16,5	4,5	ND301SA	Finitura Acciaio Satinato / Satin Steel finish
	16,5	4,5	ND301GR	Grafite / Graphite

Miscelatore monocomando da piano per lavabo.

*Single lever basin mixer for top mounting.*



H	P	Ø	art.	
28,5	19,5	4,5	ND303LU	Cromo Lucido / Polished Chrome
	19,5	4,5	ND303SA	Finitura Acciaio Satinato / Satin Steel finish
	19,5	4,5	ND303GR	Grafite / Graphite

Miscelatore monocomando da piano per lavabo.

*Single lever basin mixer for top mounting*



H	P	Ø	art.	
38,5	19,5	4,5	ND304LU	Cromo Lucido / Polished Chrome
	19,5	4,5	ND304SA	Finitura Acciaio Satinato / Satin Steel finish
	19,5	4,5	ND304GR	Grafite / Graphite

Miscelatore monocomando da piano per lavabo.

*Single lever basin mixer for top mounting*



art.  
ND902IN

Corpo ad incasso per art. ND902LU, art. ND902SA, art. ND902GR, art. ND903LU, art. ND903SA, art. ND903GR, art. ND904LU, art. ND904SA e art. ND904GR.

Concealed valve for art. ND902LU, art. ND902SA, art. ND902GR, art. ND903LU, art. ND903SA, art. ND903GR, art. ND904LU, art. ND904SA and art. ND904GR.

H	P	Ø	art.	
106	33,5	10	ND902LU	Cromo Lucido / Polished Chrome
	33,5	10	ND902SA	Finitura Acciaio Satinato / Satin Steel finish
	33,5	10	ND902GR	Grafite / Graphite

Miscelatore monocomando da terra per lavabo, escluso di corpo ad incasso.

Freestanding single lever sink mixer, concealed valve not included.

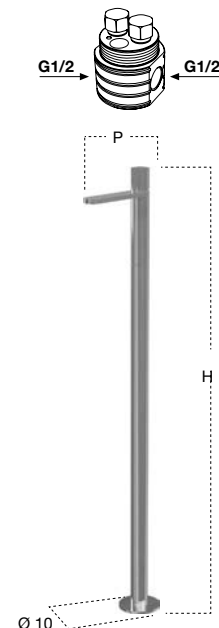

art.  
ND201INLU Cromo Lucido / Polished Chrome  
ND201INSA Finitura Acciaio Satinato / Satin Steel finish  
ND201INGR Grafite / Graphite

Corpo ad incasso per art. ND200LU, art. ND200SA, art. ND200GR, art. ND201LU, art. ND201SA e art. ND201GR.

Concealed valve for art. ND200LU, art. ND200SA, art. ND200GR, art. ND201LU, art. ND201SA and art. ND201GR.

H	P	L	art.	
7	17	20	ND200LU	Cromo Lucido / Polished Chrome
	17	20	ND200SA	Finitura Acciaio Satinato / Satin Steel finish
	17	20	ND200GR	Grafite / Graphite
	26	20	ND201LU	Cromo Lucido / Polished Chrome
	26	20	ND201SA	Finitura Acciaio Satinato / Satin Steel finish
	26	20	ND201GR	Grafite / Graphite

Miscelatore monocomando a parete per lavabo, escluso di corpo ad incasso.

Single lever wall mount sink mixer, concealed valve not included.

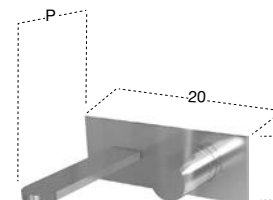
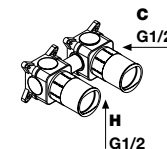

P	Ø	art.	
20	7	ND921LU	Cromo Lucido / Polished Chrome
20	7	ND921SA	Finitura Acciaio Satinato / Satin Steel finish
20	7	ND921GR	Grafite / Graphite
25	7	ND922LU	Cromo Lucido / Polished Chrome
25	7	ND922SA	Finitura Acciaio Satinato / Satin Steel finish
25	7	ND922GR	Grafite / Graphite

Erogatore a parete per lavabo, completo di corpo ad incasso.

Wall mount sink spout complete with concealed valve.

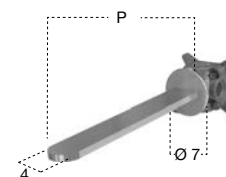

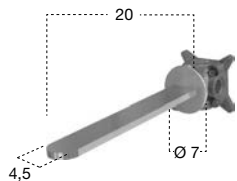

P	Ø	art.	
20	7	ND704LU	Cromo Lucido / Polished Chrome
20	7	ND704SA	Finitura Acciaio Satinato / Satin Steel finish
20	7	ND704GR	Grafite / Graphite

Erogatore a parete per vasca completo di corpo ad incasso.

*Bathtub wall spout complete with concealed valve.*

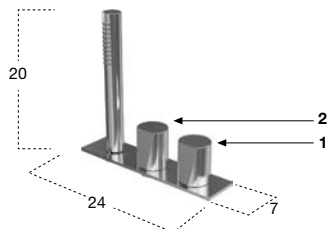

H	P	L	art.	
20	7	24	ND702LU	Cromo Lucido / Polished Chrome
	7	24	ND702SA	Finitura Acciaio Satinato / Satin Steel finish
	7	24	ND702GR	Grafite / Graphite

Gruppo bordo vasca completo di miscelatore acqua calda e fredda (1), miscelatore per doccia (2) e doccia con flessibile 150 cm a scomparsa.

*Bath rim set complete with hot and cold water mixer (1), mixer for hand shower (2) and hand shower with hidden hose 150 cm.*

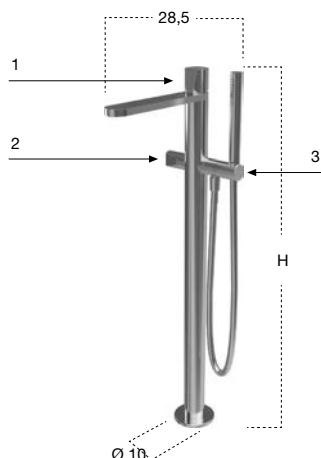
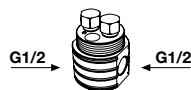

art.

ND902IN

Corpo ad incasso per Art. ND902LU, Art. ND902SA, Art. ND902GR, Art. ND903LU, Art. ND903SA, Art. ND903GR, Art. ND904LU, Art. ND904SA e Art. ND904GR, Concealed valve for Art. ND902LU, Art. ND902SA, Art. ND902GR, Art. ND903LU, Art. ND903SA, Art. ND903GR, Art. ND904LU, Art. ND904SA and Art. ND904GR,

H	P	Ø	art.	
86	28,5	10	ND903LU	Cromo Lucido / Polished Chrome
	28,5	10	ND903SA	Finitura Acciaio Satinato / Satin Steel finish
	28,5	10	ND903GR	Grafite / Graphite
94	28,5	10	ND904LU	Cromo Lucido / Polished Chrome
	28,5	10	ND904SA	Finitura Acciaio Satinato / Satin Steel finish
	28,5	10	ND904GR	Grafite / Graphite

Colonna da terra per vasca, completa di miscelatore per erogazione (1), miscelatore per doccia (2), supporto con chiusura integrata di sicurezza (3) e doccia con flessibile 150 cm, escluso di corpo ad incasso.

*Freestanding bath mixer, complete with mixer for spout (1), hand shower mixer (2) support with integrated closure for security (3) and hand shower with flexible hose 150 cm, concealed valve not included.*

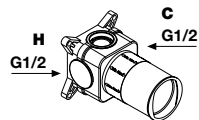

art.

ND601INLU

Cromo Lucido / Polished Chrome

ND601INSA

Finitura Acciaio Satinato / Satin Steel finish

ND601INGR

Grafite / Graphite

Corpo ad incasso per Art. ND601LU, Art. ND601SA e Art. ND601GR.

*Concealed valve for Art. ND601LU, Art. ND601SA and Art. ND601GR.*

P	Ø	art.	
4,5/7	7	ND601LU	Cromo Lucido / Polished Chrome
4,5/7	7	ND601SA	Finitura Acciaio Satinato / Satin Steel finish
4,5/7	7	ND601GR	Grafite / Graphite

Miscelatore monocomando da incasso a parete, escluso di corpo ad incasso.

*Encased wall mixer, concealed valve not included.*

H	P	L	art.	
13	6,2/8,2	8,5	ND604LU	Cromo Lucido / Polished Chrome
	6,2/8,2	8,5	ND604SA	Finitura Acciaio Satinato / Satin Steel finish
	6,2/8,2	8,5	ND604GR	Grafite / Graphite

Miscelatore termostatico completo di corpo ad incasso.

*Thermostatic mixer complete with concealed valve*

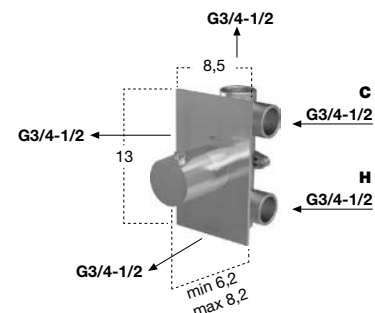

H	P	Ø	art.	
6,8	4,5/7	7	ND605LU	Cromo Lucido / Polished Chrome
	4,5/7	7	ND605SA	Finitura Acciaio Satinato / Satin Steel finish
	4,5/7	7	ND605GR	Grafite / Graphite

Rubinetto da arresto acqua calda e fredda con vitone ceramico 90°, completo di corpo ad incasso.

*Hot and cold water stop valve with 90° ceramic head, complete with concealed valve.*

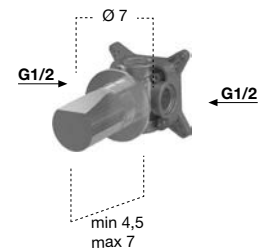

art.

ND602INLU	Cromo Lucido / Polished Chrome
ND602INSA	Finitura Acciaio Satinato / Satin Steel finish
ND602INGR	Grafite / Graphite

Corpo ad incasso per Art. ND602LU, Art. ND602SA e Art. ND602GR.

*Concealed valve for Art. ND602LU, ND602SA and Art. ND602GR.*

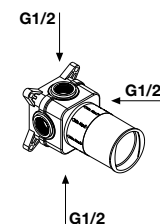

P Ø art.

4,5/7	7	ND602LU	Cromo Lucido / Polished Chrome
4,5/7	7	ND602SA	Finitura Acciaio Satinato / Satin Steel finish
4,5/7	7	ND602GR	Grafite / Graphite

Deviatore incasso a due vie, escluso di corpo ad incasso.

*Encased two way diverter, concealed valve not included.*



art.

ND603INLU	Cromo Lucido / Polished Chrome
ND603INSA	Finitura Acciaio Satinato / Satin Steel finish
ND603INGR	Grafite / Graphite

Corpo ad incasso per Art. ND603LU, Art. ND603SA e Art. ND603GR.

*Concealed valve for Art. ND603LU, Art. ND603SA and Art. ND603GR.*

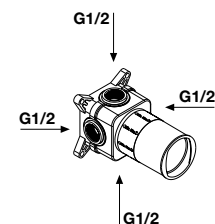

P Ø art.

4,5/7	7	ND603LU	Cromo Lucido / Polished Chrome
4,5/7	7	ND603SA	Finitura Acciaio Satinato / Satin Steel finish
4,5/7	7	ND603GR	Grafite / Graphite

Deviatore incasso a tre vie, escluso di corpo ad incasso.

*Encased three way diverter, concealed valve not included.*



# AYATI

\_2011

design  
Massimo  
Broglio

Modello e design registrato, brevetto depositato  
*Registered model and design, patent filed*



Un programma di rubinetteria per soddisfare le più diverse esigenze estetiche e funzionali, grazie all'ampia offerta dimensionale e alla possibilità di realizzare canne su misura. AYATI esalta la perfezione della geometria circolare, attraverso l'integrazione di forme cilindriche di diverso diametro che definiscono corpo, bocca, manopola e piccola leva di comando del miscelatore.

Una collezione realizzata interamente in acciaio inox AISI 304 satinato e lucido, materiale con ottime qualità igieniche che non subisce alterazioni del tempo. Disponibile nella versione AYATISIMPLE che identifica proposte da piano o da terra caratterizzate da una geometria fluida e continua, dal taglio contemporaneo, perfette per lavabi d'appoggio con altezze consistenti o per soluzioni free standing.

*A program to satisfy the most different aesthetic and functional requirements thanks to a large array of sizes and possibilities of customizing spout lengths. AYATI enhances the perfection of circular geometry through the integration of cylindrical shapes in different diameters which define the body and mouth, handle and mixer control lever.*

*A complete collection made from stainless steel AISI 304 satin or polished with a excellent hygienic quality that doesn't undergo alterations with time. Available also in the AYATISIMPLE version that identifies solutions for freestanding or counter top washbasins.*



















Programma rubinetteria di estrema versatilità, con possibilità di realizzare canne su misura, interamente realizzato in acciaio inox AISI 304, finitura satinata o lucida.  
*Highly versatile taps series, with the ability to create custom spouts, made entirely of stainless steel AISI 304, satin or polished finish.*

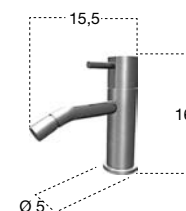

H	P	Ø	art.	
16	15,5	5	AY400SA	Acciaio Satinato / <i>Satin Stainless Steel</i>
16	15,5	5	AY400LU	Acciaio Lucido / <i>Polished Stainless Steel</i>

Miscelatore monocomando per bidet.

*Single lever mixer for bidet.*



H	P	Ø	art.	
16	15,5	5	AY301SA	Acciaio Satinato / <i>Satin Stainless Steel</i>
16	15,5	5	AY301LU	Acciaio Lucido / <i>Polished Stainless Steel</i>

Miscelatore monocomando da piano per lavabo.

*Single lever basin mixer for top mounting.*



H	P	Ø	art.	
22	15,5	5	AY302SA	Acciaio Satinato / <i>Satin Stainless Steel</i>
22	15,5	5	AY302LU	Acciaio Lucido / <i>Polished Stainless Steel</i>

Miscelatore monocomando da piano per lavabo.

*Single lever basin mixer for top mounting.*



H	P	Ø	art.	
35	27,3	5	AY303SA	Acciaio Satinato / <i>Satin Stainless Steel</i>
35	27,3	5	AY303LU	Acciaio Lucido / <i>Polished Stainless Steel</i>

Miscelatore monocomando da piano per lavabo.

*Single lever basin mixer for top mounting.*



H	P	Ø	art.	
45	27,3	5	AY304SA	Acciaio Satinato / <i>Satin Stainless Steel</i>
45	27,3	5	AY304LU	Acciaio Lucido / <i>Polished Stainless Steel</i>

Miscelatore monocomando da piano per lavabo.

*Single lever basin mixer for top mounting.*

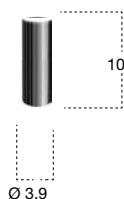

H	Ø	art.	
10	3,9	AY304PRSA	Acciaio Satinato / <i>Satin Stainless Steel</i>
10	3,9	AY304PRLU	Acciaio Lucido / <i>Polished Stainless Steel</i>

Prolunga per Art. AY304SA e Art. AY304LU.

*Extension for Art. AY304SA and Art. AY304LU.*

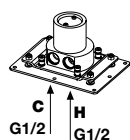

art.

AY902IN

Corpo ad incasso per art. AY902SA, art. AY902LU, art. AY903SA e art. AY903LU.

*Concealed valve for art. AY902SA, art. AY902LU, art. AY903SA and art. AY903LU.*

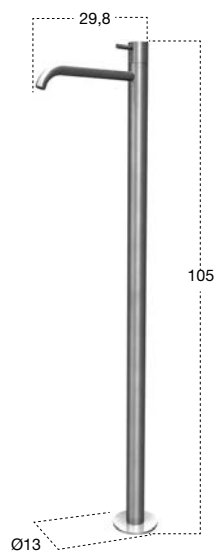

H	P	Ø	art.	
105	29,8	13	AY902SA	Acciaio Satinato / <i>Satin Stainless Steel</i>
105	29,8	13	AY902LU	Acciaio Lucido / <i>Polished Stainless Steel</i>

Miscelatore monocomando da terra per lavabo, escluso di corpo ad incasso.

*Freestanding single lever sink mixer, concealed valve not included.*

art.

AY201INSA Acciaio Satinato / *Satin Stainless Steel*

AY201INLU Acciaio Lucido / *Polished Stainless Steel*

Corpo ad incasso per art. AY202SA, art. AY202LU, art. AY200SA, art. AY200LU, art. AY201SA e art. AY201LU.

*Concealed valve for art. AY202SA, art. AY202LU, art. AY200SA, art. AY200LU, art. AY201SA and art. AY201LU.*

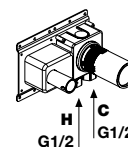

H	P	L	art.	
7,3	12,8	17,5	AY202SA	Acciaio Satinato / <i>Satin Stainless Steel</i>
7,3	12,8	17,5	AY202LU	Acciaio Lucido / <i>Polished Stainless Steel</i>
7,3	19,8	17,5	AY200SA	Acciaio Satinato / <i>Satin Stainless Steel</i>
7,3	19,8	17,5	AY200LU	Acciaio Lucido / <i>Polished Stainless Steel</i>
7,3	25,8	17,5	AY201SA	Acciaio Satinato / <i>Satin Stainless Steel</i>
7,3	25,8	17,5	AY201LU	Acciaio Lucido / <i>Polished Stainless Steel</i>

Miscelatore monocomando a parete per lavabo, escluso di corpo ad incasso.

*Single lever wall mount sink mixer, concealed valve not included.*

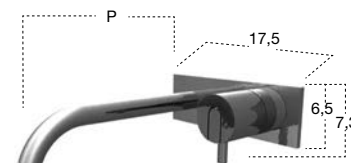

art.

AY921IN

Corpo ad incasso per art. AY920SA, art. AY920LU, art. AY921SA, art. AY921LU, art. AY922SA e art. AY922LU.

*Concealed valve for art. AY920SA, art. AY920LU, art. AY921SA, art. AY921LU art. AY922SA and art. AY922LU.*

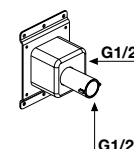

H	P	Ø	art.	
7,3	12,8	6,5	AY920SA	Acciaio Satinato / <i>Satin Stainless Steel</i>
7,3	12,8	6,5	AY920LU	Acciaio Lucido / <i>Polished Stainless Steel</i>
7,3	19,8	6,5	AY921SA	Acciaio Satinato / <i>Satin Stainless Steel</i>
7,3	19,8	6,5	AY921LU	Acciaio Lucido / <i>Polished Stainless Steel</i>
7,3	25,8	6,5	AY922SA	Acciaio Satinato / <i>Satin Stainless Steel</i>
7,3	25,8	6,5	AY922LU	Acciaio Lucido / <i>Polished Stainless Steel</i>

Erogatore a parete per lavabo, escluso di corpo a incasso.

*Wall mount sink spout, concealed valve not included.*

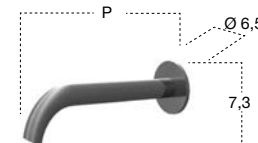

art.

AY600INSA Acciaio Satinato / *Satin Stainless Steel*

AY600INLU Acciaio Lucido / *Polished Stainless Steel*

Corpo ad incasso per art. AY600SA e art. AY600LU.

*Concealed valve for art. AY600SA and art. AY600LU.*

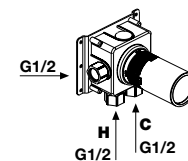

H	P	Ø	art.	
6,8	4,5/7	6,5	AY600SA	Acciaio Satinato / <i>Satin Stainless Steel</i>
6,8	4,5/7	6,5	AY600LU	Acciaio Lucido / <i>Polished Stainless Steel</i>

Miscelatore monocomando per lavabo da incasso a parete, escluso di corpo a incasso.

*Single lever sink mixer for wall encasing, concealed valve not included.*

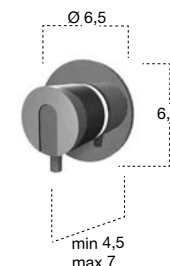

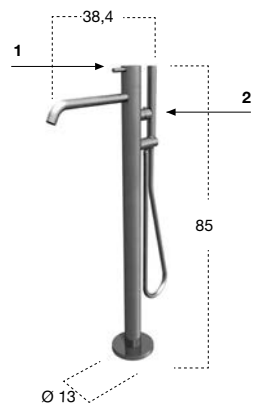
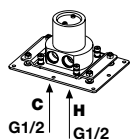

art.

AY902IN

Corpo ad incasso per art. AY902SA, art. AY902LU, art. AY903SA e art. AY903LU.

Concealed valve for art. AY902SA, art. AY902LU, art. AY903SA and art. AY903LU.

H	P	Ø	art.	
85	38,4	13	AY903SA	Acciaio Satinato / Satin Stainless Steel
85	38,4	13	AY903LU	Acciaio Lucido / Polished Stainless Steel

Colonna da terra per vasca, completa di miscelatore per erogazione (1), miscelatore per doccia (2) e doccia con flessibile 150 cm, escluso di corpo ad incasso.

Freestanding bath mixer, complete with mixer for spout (1), hand shower mixer (2) and hand shower with flexible hose 150 cm, concealed valve not included.

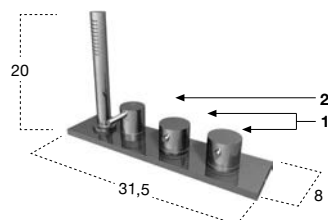

H	P	L	art.	
20	8	31,5	AY702SA	Acciaio Satinato / Satin Stainless Steel
20	8	31,5	AY702LU	Acciaio Lucido / Polished Stainless Steel

Gruppo bordo vasca completo di rubinetti di comando acqua calda e fredda (1), miscelatore per doccia (2) e doccia con flessibile 150 cm a scomparsa.

Bath rim set complete with hot and cold water handles (1), shower mixer (2) and hand shower with hidden hose 150 cm.

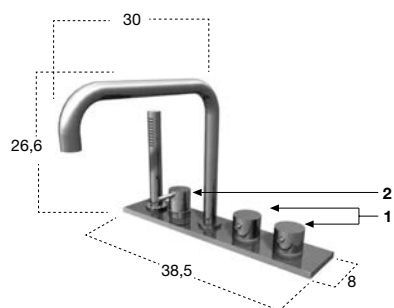

H	P	L	art.	
26,6	30	38,5	AY701SA	Acciaio Satinato / Satin Stainless Steel
26,6	30	38,5	AY701LU	Acciaio Lucido / Polished Stainless Steel

Gruppo bordo vasca completo di erogatore, rubinetti di comando acqua calda e fredda (1), miscelatore per doccia (2) e doccia con flessibile 150 cm a scomparsa.

Bath rim set complete with spout, hot and cold water handles (1), shower mixer (2) and hand shower with hidden hose 150 cm.



art.

AY601INSA Acciaio Satinato / *Satin Stainless Steel*

AY601INLU Acciaio Lucido / *Polished Stainless Steel*

Corpo ad incasso per art. AY601SA e art. AY601LU.

*Concealed valve for art. AY601SA and art. AY601LU.*

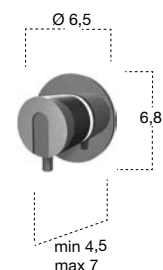
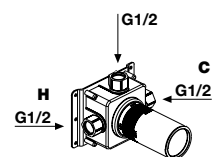

H	P	Ø	art.	
6,8	4,5/7	6,5	AY601SA	Acciaio Satinato / <i>Satin Stainless Steel</i>
6,8	4,5/7	6,5	AY601LU	Acciaio Lucido / <i>Polished Stainless Steel</i>

Miscelatore monocomando per doccia da incasso a parete, escluso di corpo a incasso.

*Single lever shower mixer for wall encasing, concealed valve not included.*

art.

AY604INSA Acciaio Satinato / *Satin Stainless Steel*

AY604INLU Acciaio Lucido / *Polished Stainless Steel*

Corpo ad incasso per art. AY604SA e art. AY604LU.

*Concealed valve for art. AY604SA and art. AY604LU.*

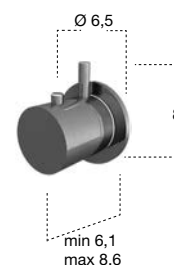
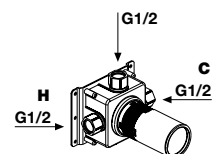

H	P	Ø	art.	
8	6,1/8,6	6,5	AY604SA	Acciaio Satinato / <i>Satin Stainless Steel</i>
8	6,1/8,6	6,5	AY604LU	Acciaio Lucido / <i>Polished Stainless Steel</i>

Miscelatore termostatico coassiale con apertura e chiusura acqua, escluso di corpo a incasso.

*Coaxial thermostatic mixer with command handle, concealed valve not included.*

art.

AY602INSA Acciaio Satinato / *Satin Stainless Steel*

AY602INLU Acciaio Lucido / *Polished Stainless Steel*

Corpo ad incasso per art. AY602SA e art. AY602LU.

*Concealed valve for art. AY602SA and art. AY602LU.*

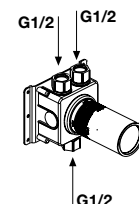

P	Ø	art.	
4,5/7	6,5	AY602SA	Acciaio Satinato / <i>Satin Stainless Steel</i>
4,5/7	6,5	AY602LU	Acciaio Lucido / <i>Polished Stainless Steel</i>

Deviatore incasso a due vie, escluso di corpo ad incasso.

*Encased two way diverter, concealed valve not included.*

art.

AY603INSA Acciaio Satinato / *Satin Stainless Steel*

AY603INLU Acciaio Lucido / *Polished Stainless Steel*

Corpo ad incasso per art. AY603SA e art. AY603LU.

*Concealed valve for art. AY603SA and art. AY603LU.*

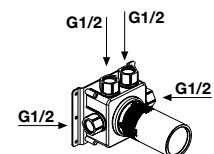

P	Ø	art.	
4,5/7	6,5	AY603SA	Acciaio Satinato / <i>Satin Stainless Steel</i>
4,5/7	6,5	AY603LU	Acciaio Lucido / <i>Polished Stainless Steel</i>

Deviatore incasso a tre vie, escluso di corpo a incasso.

*Encased three way diverter, concealed valve not included.*

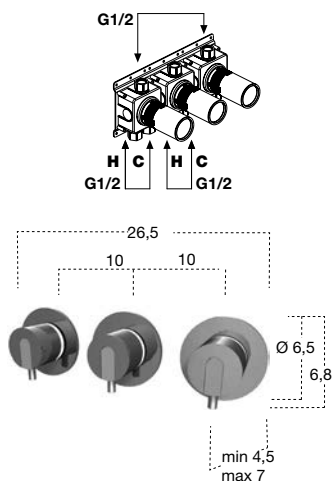
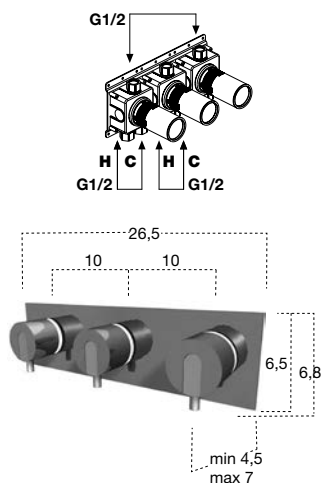
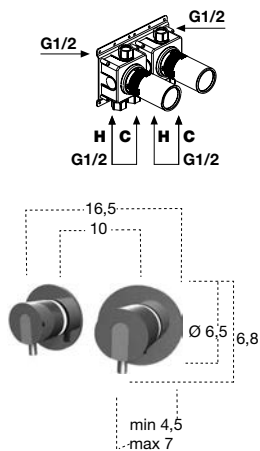
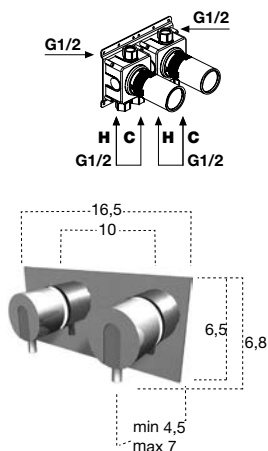

art.

AY650INSA Acciaio Satinato / *Satin Stainless Steel*

AY650INLU Acciaio Lucido / *Polished Stainless Steel*

Corpo ad incasso per art. AY650PSA, art. AY650PLU, art. AY650RSA e art. AY650RLU.

*Concealed valve for art. AY650PSA, art. AY650PLU, art. AY650RSA and art. AY650RLU.*

H P L art.

6,8 4,5/7 16,5 AY650PSA Acciaio Satinato / *Satin Stainless Steel*

6,8 4,5/7 16,5 AY650PLU Acciaio Lucido / *Polished Stainless Steel*

Composizione doccia (2 miscelatori), escluso di corpo a incasso.

*Shower set (2 mixers), concealed valve not included.*

art.

AY650INSA Acciaio Satinato / *Satin Stainless Steel*

AY650INLU Acciaio Lucido / *Polished Stainless Steel*

Corpo ad incasso per art. AY650PSA, art. AY650PLU, art. AY650RSA e art. AY650RLU.

*Concealed valve for art. AY650PSA, art. AY650PLU, art. AY650RSA and art. AY650RLU.*

H P L art.

6,8 4,5/7 16,5 AY650RSA Acciaio Satinato / *Satin Stainless Steel*

6,8 4,5/7 16,5 AY650RLU Acciaio Lucido / *Polished Stainless Steel*

Composizione doccia (2 miscelatori), escluso di corpo a incasso.

*Shower set (2 mixers), concealed valve not included.*

art.

AY651INSA Acciaio Satinato / *Satin Stainless Steel*

AY651INLU Acciaio Lucido / *Polished Stainless Steel*

Corpo ad incasso per art. AY651PSA, art. AY651PLU, art. AY651RSA e art. AY651RLU.

*Concealed valve for art. AY651PSA, art. AY651PLU, art. AY651RSA and art. AY651RLU.*

H P L art.

6,8 4,5/7 26,5 AY651PSA Acciaio Satinato / *Satin Stainless Steel*

6,8 4,5/7 26,5 AY651PLU Acciaio Lucido / *Polished Stainless Steel*

Composizione doccia (3 miscelatori), escluso di corpo a incasso.

*Shower set (3 mixers), concealed valve not included.*

art.

AY651INSA Acciaio Satinato / *Satin Stainless Steel*

AY651INLU Acciaio Lucido / *Polished Stainless Steel*

Corpo ad incasso per art. AY651PSA, art. AY651PLU, art. AY651RSA e art. AY651RLU.

*Concealed valve for art. AY651PSA, art. AY651PLU, art. AY651RSA and art. AY651RLU.*

H P L art.

6,8 4,5/7 26,5 AY651RSA Acciaio Satinato / *Satin Stainless Steel*

6,8 4,5/7 26,5 AY651RLU Acciaio Lucido / *Polished Stainless Steel*

Composizione doccia (3 miscelatori), escluso di corpo ad incasso.

*Shower set (3 mixers), concealed valve not included.*

art.

AY652INSA Acciaio Satinato / *Satin Stainless Steel*

AY652INLU Acciaio Lucido / *Polished Stainless Steel*

Corpo ad incasso per art. AY652PSA, art. AY652PLU, art. AY652RSA e art. AY652RLU.

*Concealed valve for art. AY652PSA, art. AY652PLU, art. AY652RSA and art. AY652RLU.*

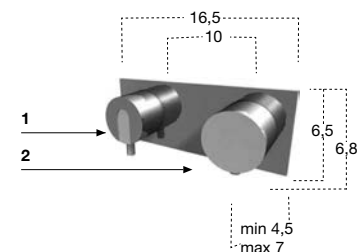
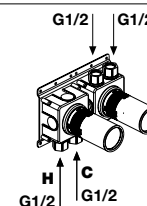

H P L art.

6,8 4,5/7 16,5 AY652PSA Acciaio Satinato / *Satin Stainless Steel*

6,8 4,5/7 16,5 AY652PLU Acciaio Lucido / *Polished Stainless Steel*

Composizione doccia 1 miscelatore (1) e 1 deviatore 2 vie (2), escluso di corpo a incasso.

*Shower set 1 mixer (1), 1 two way diverter (2), concealed valve not included.*

art.

AY652INSA Acciaio Satinato / *Satin Stainless Steel*

AY652INLU Acciaio Lucido / *Polished Stainless Steel*

Corpo ad incasso per art. AY652PSA, art. AY652PLU, art. AY652RSA e art. AY652RLU.

*Concealed valve for art. AY652PSA, art. AY652PLU, art. AY652RSA and art. AY652RLU.*

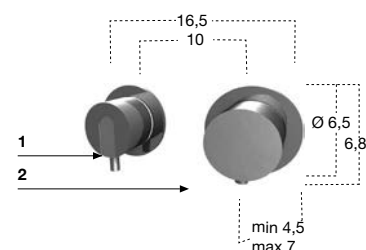
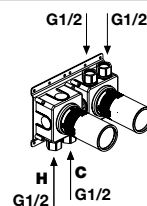

H P L art.

6,8 4,5/7 16,5 AY652RSA Acciaio Satinato / *Satin Stainless Steel*

6,8 4,5/7 16,5 AY652RLU Acciaio Lucido / *Polished Stainless Steel*

Composizione doccia 1 miscelatore (1) e 1 deviatore 2 vie (2), escluso di corpo a incasso.

*Shower set 1 mixer (1), 1 two way diverter (2), concealed valve not included.*

art.

AY653INSA Acciaio Satinato / *Satin Stainless Steel*

AY653INLU Acciaio Lucido / *Polished Stainless Steel*

Corpo ad incasso per art. AY653PSA, art. AY653PLU, art. AY653RSA e art. AY653RLU.

*Concealed valve for art. AY653PSA, art. AY653PLU, art. AY653RSA and art. AY653RLU.*

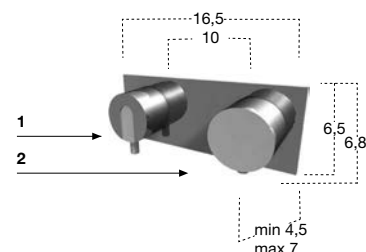
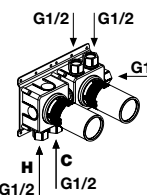

H P L art.

6,8 4,5/7 16,5 AY653PSA Acciaio Satinato / *Satin Stainless Steel*

6,8 4,5/7 16,5 AY653PLU Acciaio Lucido / *Polished Stainless Steel*

Composizione doccia 1 miscelatore (1) e 1 deviatore 3 vie (2), escluso di corpo a incasso.

*Shower set 1 mixer (1), 1 three way diverter (2), concealed valve not included.*

art.

AY653INSA Acciaio Satinato / *Satin Stainless Steel*

AY653INLU Acciaio Lucido / *Polished Stainless Steel*

Corpo ad incasso per art. AY653PSA, art. AY653PLU, art. AY653RSA e art. AY653RLU.

*Concealed valve for art. AY653PSA, art. AY653PLU, art. AY653RSA and art. AY653RLU.*

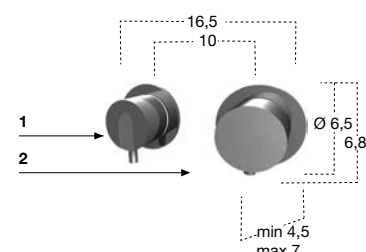
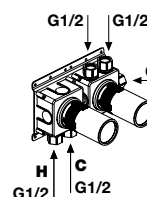

H P L art.

6,8 4,5/7 16,5 AY653RSA Acciaio Satinato / *Satin Stainless Steel*

6,8 4,5/7 16,5 AY653RLU Acciaio Lucido / *Polished Stainless Steel*

Composizione doccia 1 miscelatore (1) e 1 deviatore 3 vie (2), escluso di corpo a incasso.

*Shower set 1 mixer (1), 1 three way diverter (2), concealed valve not included.*

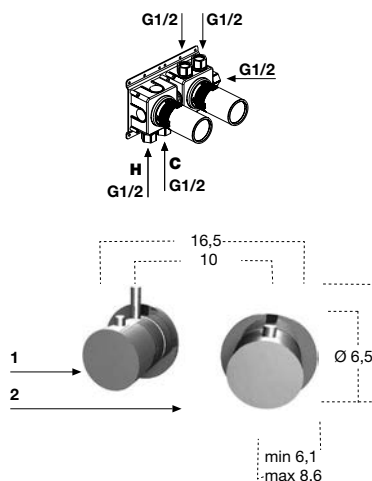
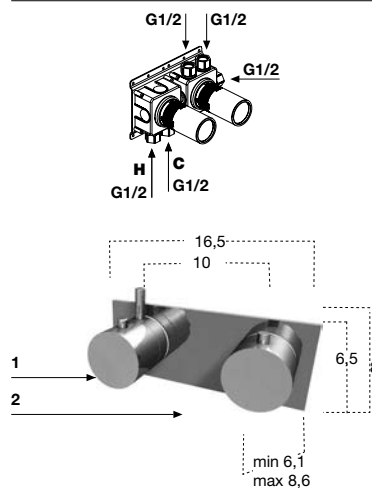
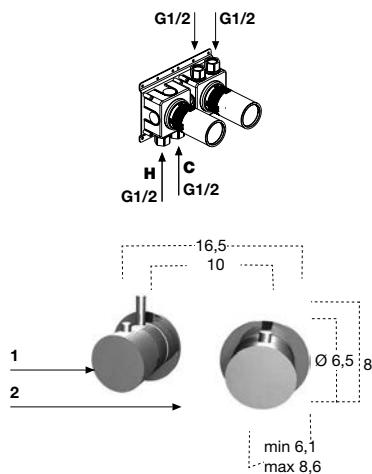
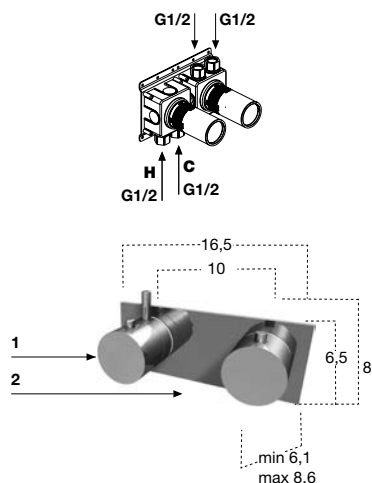

art.

AY654INSA Acciaio Satinato / *Satin Stainless Steel*

AY654INLU Acciaio Lucido / *Polished Stainless Steel*

Corpo ad incasso per art. AY654PSA, art. AY654PLU, art. AY654RSA e art. AY654RLU.

*Concealed valve for art. AY654PSA, art. AY654PLU, art. AY654RSA and art. AY654RLU.*

H	P	L	art.
8	6,1/8,6	16,5	AY654PSA Acciaio Satinato / <i>Satin Stainless Steel</i>
8	6,1/8,6	16,5	AY654PLU Acciaio Lucido / <i>Polished Stainless Steel</i>

Composizione doccia 1 termostatico coassiale con apertura e chiusura acqua (1) e 1 deviatore 2 vie (2), escluso di corpo a incasso.

*Shower set 1 coaxial thermostatic with command handle (1), 1 two way diverter (2), concealed valve not included.*

art.

AY654INSA Acciaio Satinato / *Satin Stainless Steel*

AY654INLU Acciaio Lucido / *Polished Stainless Steel*

Corpo ad incasso per art. AY654PSA, art. AY654PLU, art. AY654RSA e art. AY654RLU.

*Concealed valve for art. AY654PSA, art. AY654PLU, art. AY654RSA and art. AY654RLU.*

H	P	L	art.
8	6,1/8,6	16,5	AY654RSA Acciaio Satinato / <i>Satin Stainless Steel</i>
8	6,1/8,6	16,5	AY654RLU Acciaio Lucido / <i>Polished Stainless Steel</i>

Composizione doccia 1 termostatico coassiale con apertura e chiusura acqua (1) e 1 deviatore 2 vie (2), escluso di corpo a incasso.

*Shower set 1 coaxial thermostatic with command handle (1), 1 two way diverter (2), concealed valve not included.*

art.

AY655INSA Acciaio Satinato / *Satin Stainless Steel*

AY655INLU Acciaio Lucido / *Polished Stainless Steel*

Corpo ad incasso per art. AY655PSA, art. AY655PLU, art. AY655RSA e art. AY655RLU.

*Concealed valve for art. AY655PSA, art. AY655PLU, art. AY655RSA and art. AY655RLU.*

H	P	L	art.
8	6,1/8,6	16,5	AY655PSA Acciaio Satinato / <i>Satin Stainless Steel</i>
8	6,1/8,6	16,5	AY655PLU Acciaio Lucido / <i>Polished Stainless Steel</i>

Composizione doccia 1 termostatico coassiale con apertura e chiusura acqua (1) e 1 deviatore 3 vie (2), escluso di corpo a incasso.

*Shower set 1 coaxial thermostatic with command handle (1), 1 three way diverter (2), concealed valve not included.*

art.

AY655INSA Acciaio Satinato / *Satin Stainless Steel*

AY655INLU Acciaio Lucido / *Polished Stainless Steel*

Corpo ad incasso per art. AY655PSA, art. AY655PLU, art. AY655RSA e art. AY655RLU.

*Concealed valve for art. AY655PSA, art. AY655PLU, art. AY655RSA and art. AY655RLU.*

H	P	L	art.
8	6,1/8,6	16,5	AY655RSA Acciaio Satinato / <i>Satin Stainless Steel</i>
8	6,1/8,6	16,5	AY655RLU Acciaio Lucido / <i>Polished Stainless Steel</i>

Composizione doccia 1 termostatico coassiale con apertura e chiusura acqua (1) e 1 deviatore 3 vie (2), escluso di corpo a incasso.

*Shower set 1 coaxial thermostatic with command handle (1), 1 three way diverter (2), concealed valve not included.*

H	P	L	art.	
105,6	7,6	10	ASTA151SA	Acciaio Satinato / <i>Satin Stainless Steel</i>
105,6	7,6	10	ASTA151LU	Cromo Lucido / <i>Polished Chrome</i>

Doccetta completa di asta scorrevole e presa acqua separata a parete con flessibile 150 cm.

*Hand shower complete with bar and separate wall mount water intake with flexible hose 150 cm.*

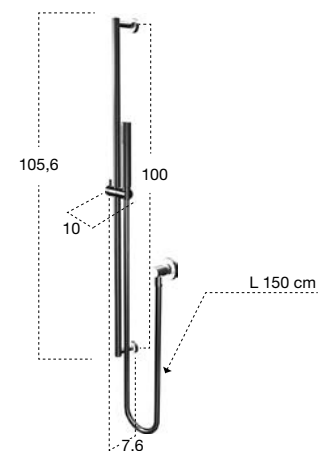

H	P	L	art.	
105,6	7,6	10	ASTA152SA	Acciaio Satinato / <i>Satin Stainless Steel</i>
105,6	7,6	10	ASTA152LU	Cromo Lucido / <i>Polished Chrome</i>

Doccetta biuso completa di asta scorrevole e presa acqua separata a parete con flessibile 150 cm.

*Hand shower complete with bar and separate wall mount water intake with flexible hose 150 cm.*

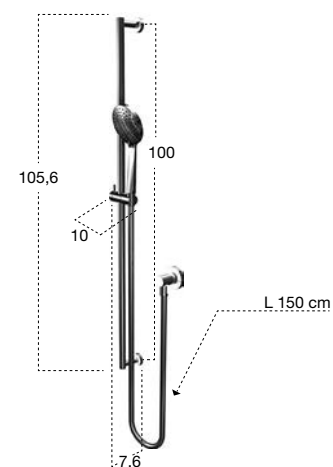

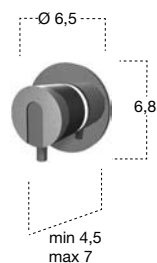
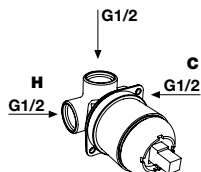
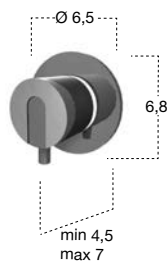
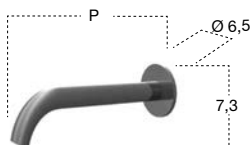
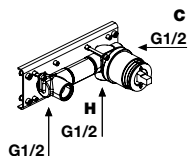

art.

SP201INSA	Acciaio Satinato / <i>Satin Stainless Steel</i>
SP201INLU	Acciaio Lucido / <i>Polished Stainless Steel</i>

Corpo ad incasso per art. AY600SA, art. AY600LU, art. AY920SA, art. AY920LU, art. AY921SA, art. AY921LU, art. AY922SA e art. AY922LU.

Concealed valve for art. AY600SA, art. AY600LU, art. AY920SA, art. AY920LU, art. AY921SA, art. AY921LU, art. AY922SA and art. AY922LU.

H	P	Ø	art.	
7,3	12,8	6,5	AY920SA	Acciaio Satinato / <i>Satin Stainless Steel</i>
7,3	12,8	6,5	AY920LU	Acciaio Lucido / <i>Polished Stainless Steel</i>
7,3	19,8	6,5	AY921SA	Acciaio Satinato / <i>Satin Stainless Steel</i>
7,3	19,8	6,5	AY921LU	Acciaio Lucido / <i>Polished Stainless Steel</i>
7,3	25,8	6,5	AY922SA	Acciaio Satinato / <i>Satin Stainless Steel</i>
7,3	25,8	6,5	AY922LU	Acciaio Lucido / <i>Polished Stainless Steel</i>

Erogatore a parete per lavabo, escluso di corpo ad incasso.

Wall mount sink spout, concealed valve not included.

H	P	Ø	art.	
6,8	4,5/7	6,5	AY600SA	Acciaio Satinato / <i>Satin Stainless Steel</i>
6,8	4,5/7	6,5	AY600LU	Acciaio Lucido / <i>Polished Stainless Steel</i>

Miscelatore monocomando per lavabo da incasso a parete, escluso di corpo ad incasso.

Single lever sink mixer for wall encasing, concealed valve not included.

art.

SP601INSA	Acciaio Satinato / <i>Satin Stainless Steel</i>
SP601INLU	Acciaio Lucido / <i>Polished Stainless Steel</i>

Corpo ad incasso per art. AY601SA e art. AY601LU.

Concealed valve for art. AY601SA and art. AY601LU.

H	P	Ø	art.	
6,8	4,5/7	6,5	AY601SA	Acciaio Satinato / <i>Satin Stainless Steel</i>
6,8	4,5/7	6,5	AY601LU	Acciaio Lucido / <i>Polished Stainless Steel</i>

Miscelatore monocomando da incasso a parete, escluso di corpo ad incasso.

Single lever mixer for wall encasing, concealed valve not included.

art.

SP604INSA Acciaio Satinato / *Satin Stainless Steel*

SP604INLU Acciaio Lucido / *Polished Stainless Steel*

Corpo ad incasso per Art. AY604SA e Art. AY604LU.

*Concealed valve for Art. AY604SA and Art. AY604LU.*

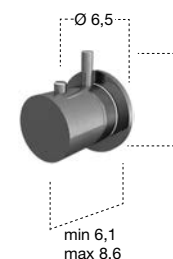
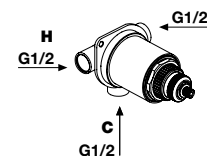

H	P	Ø	art.	
8	6,1/8,6	6,5	AY604SA	Acciaio Satinato / <i>Satin Stainless Steel</i>
8	6,1/8,6	6,5	AY604LU	Acciaio Lucido / <i>Polished Stainless Steel</i>

Miscelatore termostatico coassiale con apertura e chiusura acqua, escluso di corpo ad incasso.

*Coaxial thermostatic mixer with command handle, concealed valve not included.*

art.

SP602INSA Acciaio Satinato / *Satin Stainless Steel*

SP602INLU Acciaio Lucido / *Polished Stainless Steel*

Corpo ad incasso per Art. AY602SA e Art. AY602LU.

*Concealed valve for Art. AY602SA and Art. AY602LU.*

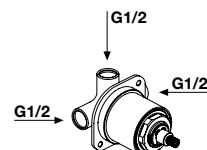

P	Ø	art.	
4,5/7	6,5	AY602SA	Acciaio Satinato / <i>Satin Stainless Steel</i>
4,5/7	6,5	AY602LU	Acciaio Lucido / <i>Polished Stainless Steel</i>

Deviatore incasso a due vie, escluso di corpo ad incasso.

*Encased two way diverter, concealed valve not included.*

art.

SP603INSA Acciaio Satinato / *Satin Stainless Steel*

SP603INLU Acciaio Lucido / *Polished Stainless Steel*

Corpo ad incasso per Art. AY603SA e Art. AY603LU

*Concealed valve for Art. AY603SA and Art. AY603LU*

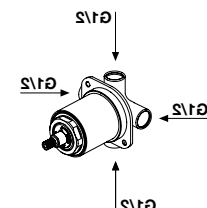

P	Ø	art.	
4,5/7	6,5	AY603SA	Acciaio Satinato / <i>Satin Stainless Steel</i>
4,5/7	6,5	AY603LU	Acciaio Lucido / <i>Polished Stainless Steel</i>

Deviatore incasso a tre vie, escluso di corpo ad incasso.

*Encased three way diverter, concealed valve not included.*

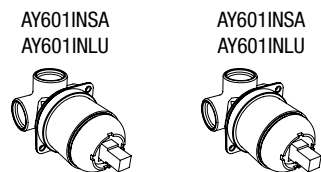

+



art.			
	N° 2	AY601INSA	Acciaio Satinato / <i>Satin Stainless Steel</i>
0 / Or	N° 2	AY601INLU	Acciaio Lucido / <i>Polished Stainless Steel</i>

+ art.

	N° 2	AY601SA	Acciaio Satinato / <i>Satin Stainless Steel</i>
0 / Or	N° 2	AY601LU	Acciaio Lucido / <i>Polished Stainless Steel</i>

Composizione doccia 2 miscelatori.

*Shower set 2 mixers.*



+



art.			
	N° 3	AY601INSA	Acciaio Satinato / <i>Satin Stainless Steel</i>
0 / Or	N° 3	AY601INLU	Acciaio Lucido / <i>Polished Stainless Steel</i>

+ art.

	N° 3	AY601SA	Acciaio Satinato / <i>Satin Stainless Steel</i>
0 / Or	N° 3	AY601LU	Acciaio Lucido / <i>Polished Stainless Steel</i>

Composizione doccia 3 miscelatori.

*Shower set 3 mixers.*

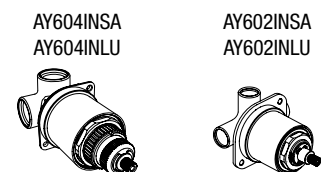

+



art.			
	N° 1	AY604INSA	Acciaio Satinato / <i>Satin Stainless Steel</i>
	N° 1	AY602INSA	Acciaio Satinato / <i>Satin Stainless Steel</i>
0 / Or	N° 1	AY604INLU	Acciaio Lucido / <i>Polished Stainless Steel</i>
	N° 1	AY602INLU	Acciaio Lucido / <i>Polished Stainless Steel</i>

+ art.

	N° 1	AY604SA	Acciaio Satinato / <i>Satin Stainless Steel</i>
	N° 1	AY602SA	Acciaio Satinato / <i>Satin Stainless Steel</i>
0 / Or	N° 1	AY604LU	Acciaio Lucido / <i>Polished Stainless Steel</i>
	N° 1	AY602LU	Acciaio Lucido / <i>Polished Stainless Steel</i>

Composizione doccia 1 miscelatore termostatico e 1 deviatore a 2 vie.

*Shower set 1 thermostatic mixer and 1 2-way diverter.*

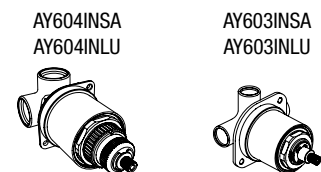

+



art.			
	N° 1	AY604INSA	Acciaio Satinato / <i>Satin Stainless Steel</i>
	N° 1	AY603INSA	Acciaio Satinato / <i>Satin Stainless Steel</i>
0 / Or	N° 1	AY604INLU	Acciaio Lucido / <i>Polished Stainless Steel</i>
	N° 1	AY603INLU	Acciaio Lucido / <i>Polished Stainless Steel</i>

+ art.

	N° 1	AY604SA	Acciaio Satinato / <i>Satin Stainless Steel</i>
	N° 1	AY603SA	Acciaio Satinato / <i>Satin Stainless Steel</i>
0 / Or	N° 1	AY604LU	Acciaio Lucido / <i>Polished Stainless Steel</i>
	N° 1	AY603LU	Acciaio Lucido / <i>Polished Stainless Steel</i>

Composizione doccia 1 miscelatore termostatico e 1 deviatore a 3 vie.

*Shower set 1 thermostatic mixer and 1 3-way diverter.*





# BIKAPPA

\_2005

design  
Carlo  
Colombo

Un carattere contemporaneo e deciso, determinato dalla sezione rettangolare della bocca di erogazione sottile e slanciata. Un perfetto equilibrio geometrico e proporzionale tra bocca e corpo del miscelatore che definisce un'immagine moderna e un mix armonioso di forme diverse. La collezione di rubinetteria Bikappa, si arricchisce di due nuove finiture in linea con le ultime tendenze dell'interior design e in particolare dell'utilizzo sempre crescente di metalli nobili all'interno dell'ambiente bagno. Oro Rosa e Cromo Nero Spazzolato, sono le due nuove versioni, che amplificano la versatilità della collezione conferendole un carattere diverso per qualsiasi esigenza formale. L'oro rosa, assicura eleganza e gusto retrò alla rubinetteria per inserirsi anche in contesti classici, il cromo nero spazzolato, la proietta in una dimensione urbana e metropolitana fatta di estetica raw e riferimenti vintage. Entrambi assicurano nuove identità al miscelatore, perfette per alimentare quella contaminazione di stili che oggi interessa anche l'ambiente bagno.

*A contemporary character and determination established by the rectangular section of the slim and slender spout. A perfect geometric proportion and balance between the spout and the mixing valve defining a modern image and a harmonious blend of shapes. The Bikappa tap collection is enriched with two new finishes in line with the latest trends of interior design and in particular the increasing use of noble metals within the bathroom. Rose Gold and Black Brushed Chrome are the two new versions that boost the versatility of giving the collection a different font for any formal requirement. The rose gold ensures elegance and retro feel to the taps to also fit in classical contexts, brushed black chrome projects in the urban and metropolitan dimension made of raw aesthetic and vintage references. Both provide new identities to the mixer, perfect for powering the contamination of styles which now also are interesting in the bathroom.*





oro rosa  
rose gold



*cromo nero spazzolato  
black brushed chrome*



BIKAPPA



















RUBINETTERIA  
TAPS





BIKAPPA







## BIKAPPA

Realizzato in ottone con finitura CROMO LUCIDO, ORO ROSA e CROMO NERO SPAZZOLATO.  
Produced in brass with a POLISHED CHROME FINISH, ROSE GOLD and BLACK BRUSHED CHROME.

---

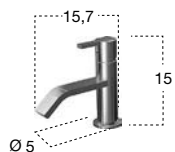

H	P	Ø	art.
15	15,7	5	BK400N

Monocomando da piano per lavabo o bidet.

*Single lever sink mixer for sink or bidet.*

---



H	P	Ø	art.
22	24	5	BK300N

Monocomando da piano per lavabo.

*Single lever sink mixer.*

---



H	P	Ø	art.
35	24	5	BK904N

Monocomando da piano per lavabo.

*Single lever sink mixer.*

---



H	P	Ø	art.
43	24	5	BK905N

Monocomando da piano per lavabo.

*Single lever sink mixer.*



H	Ø	art.
6	3,5	BK400PR
12	4,2	BK905PR

Prolunga H 6 cm per art. BK400N e H 12 cm per art. BK905N.

*Extension 6 cm H for art. BK904N and 12 cm H for art. BK905N.*

art.

BK201I

Corpo ad incasso reversibile per Art. BK200N e Art. BK201N.

*Reversible concealed valve for Art. BK200N and Art. BK201N.*

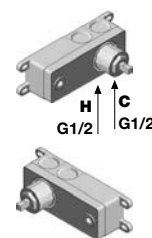

H	P	L	art.
11	20	20	BK200N
11	25	20	BK201N

Monocomando reversibile a parete per lavabo, escluso di corpo ad incasso.

*Reversible single lever wall mount sink mixer, concealed valve not included.*

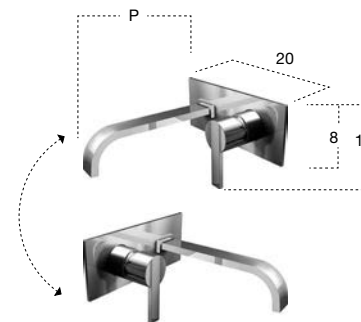

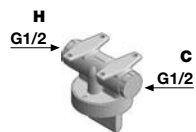

art.

BK906I

Corpo ad incasso per Art. BK906N, Art. BK907N, Art. BK908N e Art. BK909N.

*Concealed valve for Art. BK906N, Art. BK907N, Art. BK908N and Art. BK909N.*

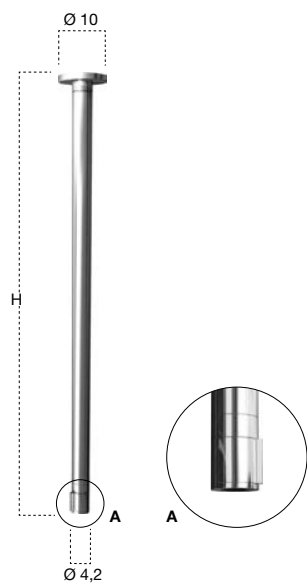

H Ø art.

120 10 BK906N

130 10 BK907N

140 10 BK908N

150 10 BK909N

Colonna da soffitto per lavabo con sistema di comando progressivo, escluso di corpo a incasso.

*Ceiling mounted basin mixer with progressive mixer control, concealed valve not included.*



art.

BK903IN

Corpo ad incasso per Art. BK902N e Art. BK903N.

*Concealed valve for Art. BK902N and Art. BK903N.*

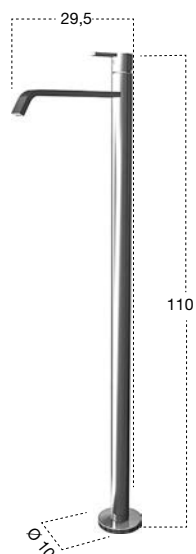

H P Ø art.

110 29,5 10 BK902N

Monocomando da terra per lavabo, escluso di corpo a incasso.

*Freestanding single lever sink mixer, concealed valve not included.*

art.

BK903IN

Corpo ad incasso per Art. BK902N e Art. BK903N.

*Concealed valve for Art. BK902N and Art. BK903N.*

H	P	L	art.
80,7	29,5	17	BK903N

Colonna da terra per vasca, completa di miscelatore per erogatore (1), miscelatore per doccia (2), doccia con flessibile 150 cm, escluso di corpo a incasso.

*Freestanding bath mixer complete with single lever for spout (1) shower mixer (2) hand shower with hose 150 cm, concealed valve not included.*

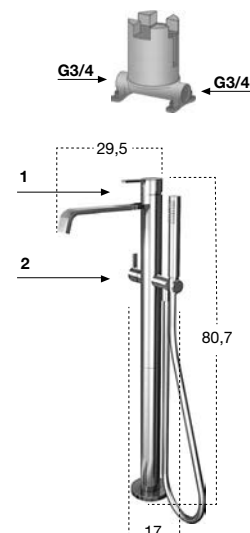

RUBINETTERIA  
TAPS

H	P	L	art.
20,8	8	31,5	BK702

Gruppo bordo vasca completo di rubinetti di comando acqua calda e fredda (1), miscelatore per doccia (2) e doccia con flessibile 150 cm a scomparsa.

*Bath rim set complete with hot and cold water handles (1), shower mixer (2) and hand shower with hidden hose 150 cm.*

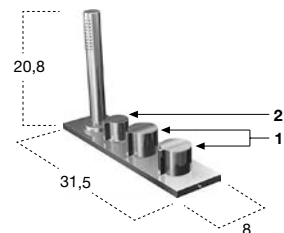

H	P	L	art.
20,8	21,5	38,5	BK701

Gruppo bordo vasca completo di erogatore, rubinetti di comando acqua calda e fredda (1), miscelatore per doccia (2) e doccia con flessibile 150 cm a scomparsa.

*Bath rim set complete with spout, hot and cold water handles (1), shower mixer (2) and hand shower with hidden hose 150 cm.*

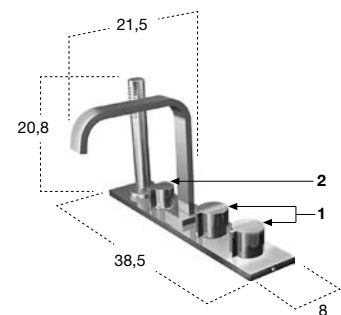

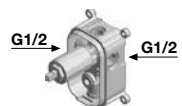

art.

BK601I

Corpo ad incasso per Art. BK601 e Art. BK616.

*Concealed valve for Art. BK601 and Art. BK616.*

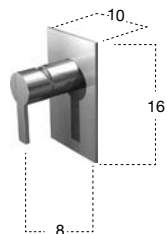

H P L art.

16 8 10 BK616

Monocomando da incasso parete, escluso di corpo ad incasso.

*Encased mixer, concealed valve not included.*

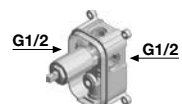

art.

BK601I

Corpo ad incasso per Art. BK601 e Art. BK616.

*Concealed valve for Art. BK601 and Art. BK616.*

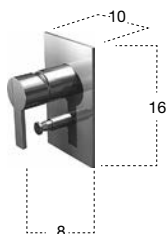

H P L art.

16 8 10 BK601

Monocomando da incasso parete con deviatore, escluso di corpo ad incasso.

*Encased mixer with diverter, concealed valve not included.*

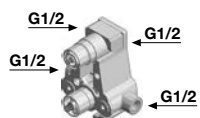

art.

BK602I

Corpo ad incasso per Art. BK602.

*Concealed valve for Art. BK602.*

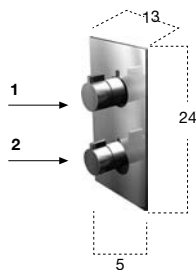

H P L art.

24 5 13 BK602

Gruppo doccia da incasso parete con miscelatore termostatico (2) e rubinetto di comando con deviatore a due vie (1), escluso di corpo ad incasso.

*Encased mixer with thermostat (2) command handle with two-way diverter (1), concealed valve not included.*

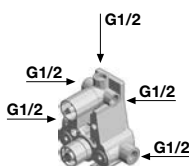

art.

BK603I

Corpo ad incasso per Art. BK603.

*Concealed valve for Art. BK603.*

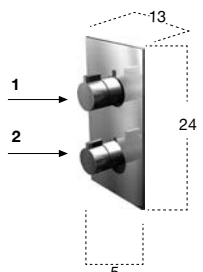

H P L art.

24 5 13 BK603

Gruppo doccia da incasso parete con miscelatore termostatico (2), rubinetto di comando con deviatore a tre vie (1), escluso di corpo ad incasso.

*Encased mixer with thermostat (2) command handle and three-way diverter (1), concealed valve not included.*

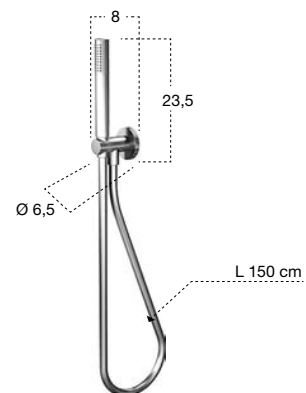

H	P	L	art.
23,5	8	6,5	BK150

Doccetta completa di supporto e presa d'acqua a parete con flessibile 150 cm.

*Hand shower with hose cm 150, wall outlet and holder.*

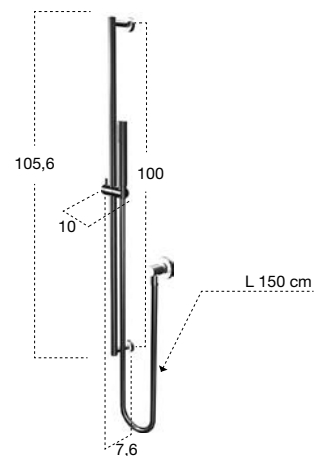

H	P	L	art.	
105,6	7,6	10	ASTA151LU	Cromo Lucido / Polished Chrome

Doccetta completa di asta scorrevole e presa acqua separata a parete con flessibile 150 cm.

*Hand shower complete with bar and separate wall mount water intake with flexible hose 150 cm.*

# TIMBRO

\_2017

design  
Roberto  
Lazzeroni



Classica ma contemporanea allo stesso tempo, perfetta nella sua coerenza di linguaggio con gli elementi della collezione ILBAGNO, che va a completare con un'immagine coordinata e con una perfetta funzionalità di ciascun elemento. Gruppo lavabo a parete o da piano, colonna da terra per vasche free standing, blocco doccia con doccetta, gruppo per bidet. Una proposta completa che trova nel binomio tra la perfetta geometria cilindrica della canna di erogazione e il carattere forte delle manopole a stella il proprio tratto distintivo. Il tutto esaltato dai riflessi del cromo lucido.

*Classical but contemporary at the same time, perfect in its synergy with the collection ILBAGNO completing it with a coordinated image and perfect functionality of each item. Wall or deck mount sink sets, freestanding columns, shower sets and bidet sets: a comprehensive proposal that is in perfect synergy with the cylindrical body of the spout and the strong character of the star shaped command handles enhanced by the polished chrome highlights.*





TIMBRO









## TIMBRO

Realizzato in ottone con finitura CROMO LUCIDO.  
Produced in brass with a POLISHED CHROME.



H	P	L	art.
16,9	17	31	TB431

Gruppo 3 fori da piano per bidet completo di erogatore e rubinetti di comando acqua calda e fredda.

*3 hole bidet mixer complete with spout and command handles for hot and cold water.*

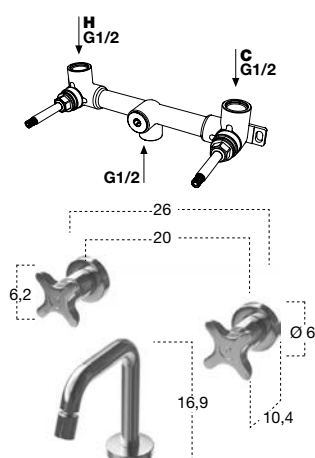

art.

TB231IN

Corpo ad incasso per art.TB432

*Concealed valve for art. TB432.*

H	P	L	art.
16,9	17	26	TB432

Erogatore per bidet completo di rubinetti di comando acqua calda e fredda, escluso di corpo ad incasso.

*Bidet spout complete with command handles for hot and cold water, concealed valve not included.*



H	P	L	art.
16,9	17	31	TB430

Gruppo 3 fori da piano per lavabo completo di erogatore e rubinetti di comando acqua calda e fredda.

*3 hole sink mixer complete with spout and command handles for hot and cold water.*

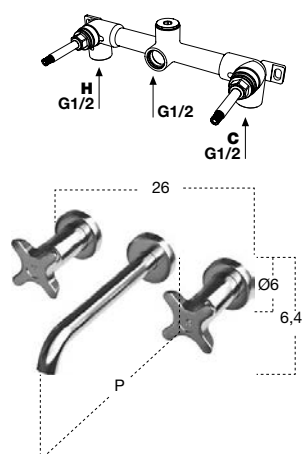

art.

TB231IN

Corpo ad incasso per art.TB230 e art.TB231.

*Concealed valve for art. TB230 and art. TB231*

H	P	L	art.
6,4	19,8	26	TB230
6,4	25,8	26	TB231

Gruppo lavabo a parete completo di erogatore e rubinetti di comando acqua calda e fredda, escluso di corpo ad incasso.

*Wall mount sink set complete with spout and hot and cold handles, concealed valve not included.*

art.

TB730IN

Corpo ad incasso per art.TB730.

Concealed valve for art. TB730.

H	P	L	art.
21	30	34,4	TB730

Gruppo vasca a parete completo di erogatore e rubinetti di comando acqua calda e fredda (1) e 1 deviatore 2 vie (2), escluso di corpo ad incasso.

Bathtub mixer set complete with spout and hot and cold command handles (1) and 1 2-way diverter (2), concealed valve not included.

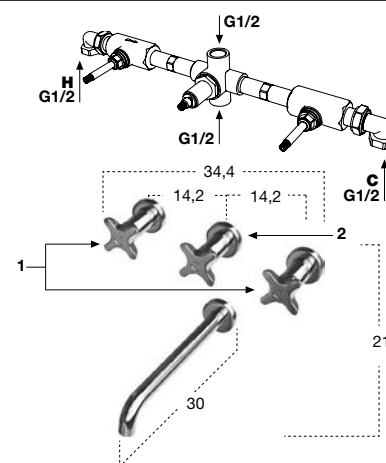

H	P	L	art.
92,7	37,5	29	TB933

Colonna da terra per vasca, completa di erogatore e rubinetti di comando acqua calda e fredda (1), deviatore per doccia (2) e doccia con flessibile 150 cm.

Freestanding bath column complete with spout and command handles (1), hand shower diverter (2) and hand shower with flexible hose 150 cm.

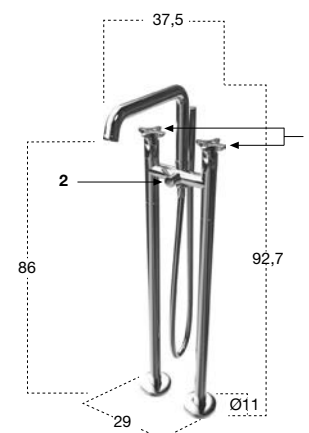

art.

TB231IN

Corpo ad incasso per art.TB631.

Concealed valve for art. TB631.

H	P	L	art.
6,2	10,4	26	TB631

Composizione doccia con rubinetti di comando acqua calda e fredda, escluso di corpo ad incasso.

Shower set of hot and cold water command handles, concealed valve not included.

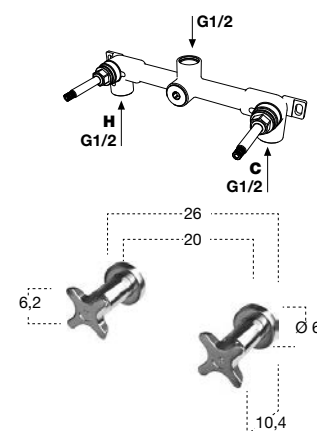

art.

TB730IN

Corpo ad incasso per art.TB682.

Concealed valve for art. TB682.

H	P	L	art.
6,2	10,4	34,4	TB682

Composizione doccia con rubinetti di comando acqua calda e fredda (1) e 1 deviatore 2 vie (2), escluso di corpo ad incasso.

Shower set of hot and cold water command handles (1) and 1 2-way diverter (2), concealed valve not included.

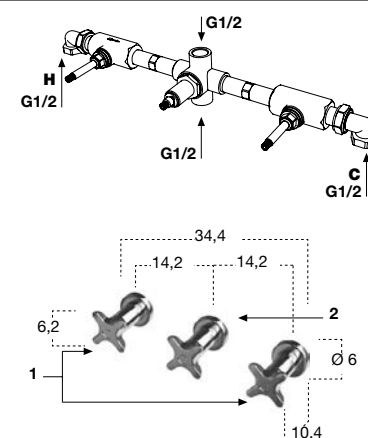

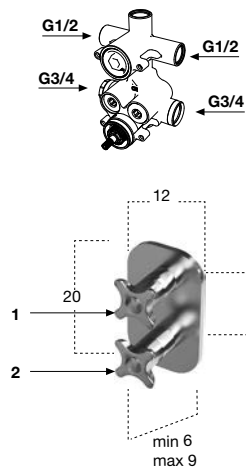

art.  
**TB602IN**  
 Corpo ad incasso per art.TB601, art.TB602 e art.TB603.  
*Concealed valve for art. TB601, art. TB602 and art. TB603.*

H	P	L	art.
20	6/9	12	TB601

Gruppo doccia da incasso a parete con miscelatore termostatico (2) e rubinetto di comando (1), escluso di corpo ad incasso.  
*Encased shower set with thermostatic mixer (2) and command handle (1), concealed valve not included.*

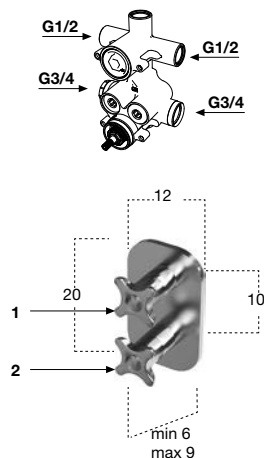

art.  
**TB602IN**  
 Corpo ad incasso per art.TB601, art.TB602 e art.TB603.  
*Concealed valve for art. TB601, art. TB602 and art. TB603.*

H	P	L	art.
20	6/9	12	TB602

Gruppo doccia da incasso a parete con miscelatore termostatico (2) e rubinetto di comando con deviatore a due vie (1), escluso di corpo ad incasso.  
*Encased mixer with thermostat (2) command handle with two-way diverter (1), concealed valve not included.*

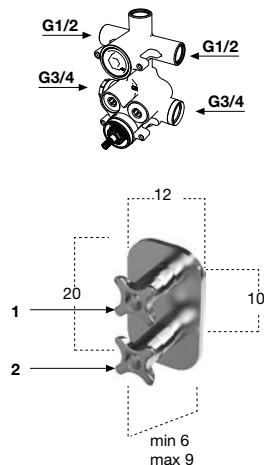

art.  
**TB602IN**  
 Corpo ad incasso per art.TB601, art.TB602 e art.TB603.  
*Concealed valve for art. TB601, art. TB602 and art. TB603.*

H	P	L	art.
20	6/9	12	TB603

Gruppo doccia da incasso a parete con miscelatore termostatico (2) e rubinetto di comando con deviatore a tre vie (1), escluso di corpo ad incasso.  
*Encased mixer with thermostat (2) command handle with three-way diverter (1), concealed valve not included.*



H	P	L	art.
19,7	24,2	3,1	TB150

Doccetta completa di supporto e presa d'acqua a parete con flessibile 150 cm.

*Hand shower with hose 150 cm, wall outlet and holder.*

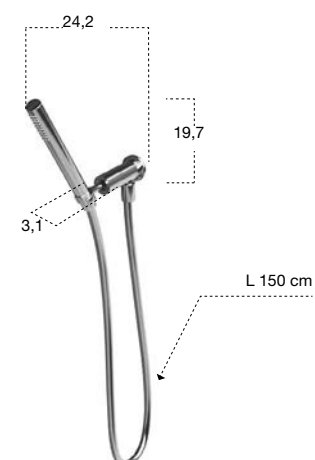

H	P	L	art.
105,6	7,6	10	ASTA151LU Cromo Lucido / Polished Chrome

Doccetta completa di asta scorrevole e presa acqua separata a parete con flessibile 150 cm.

*Hand shower complete with bar and separate wall mount water intake with flexible hose 150 cm.*

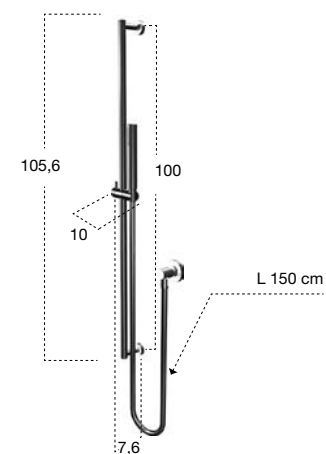



antoniolupi

PIATTI E BOX DOCCIA  
*TRAYS AND SHOWER ENCLOSURES*





PIATTE BOX DOCCIA  
SHOWER ENCLOSURES

BILICO



vetro extrachiaro  
extra-clear glass



PIATTE BOX DOCCIA  
SHOWER ENCLOSURES

BILICO



vetro extrachiaro  
extra-clear glass





vetro riflettente fumé  
reflective fumé glass

PIATTE BOX DOCCIA  
SHOWER ENCLOSURES



art.

BILICO1N

da / a - from / to

H	L
198,3	67 / 77
	78 / 90

Box doccia dx o sx in vetro temperato spess. 8 mm per piatti doccia SUMISURA, ZEROMATT, 00\_XL e 00\_ST tra pareti in nicchia, completo di perno e barra di sostegno.

Right or left shower enclosure in 8 mm tempered glass for shower tray SUMISURA, ZEROMATT, 00\_XL and 00\_ST within a recessed area, complete with pin and supporting bar.

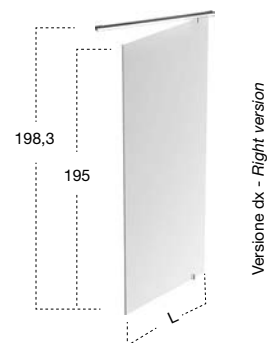

- Rivestimento.  
- Tile Coating.

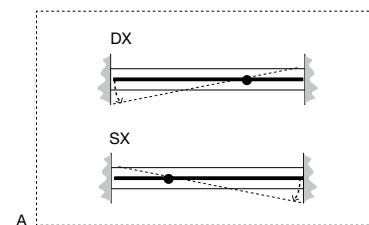
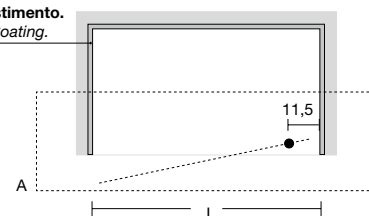

art.

BILICO5N

da / a - from / to

H	L
198,3	117 / 137

Box doccia dx o sx in vetro temperato spess. 8 mm per piatti doccia SUMISURA, ZEROMATT, 00\_XL e 00\_ST tra pareti in nicchia, completo di perno centrale e barra di sostegno.

Right or left shower enclosure in 8 mm tempered glass for shower tray SUMISURA, ZEROMATT, 00\_XL and 00\_ST within a recessed area, complete with center pin and supporting bar.

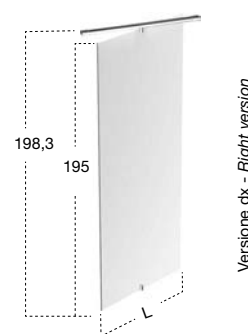

- Rivestimento.  
- Tile Coating.

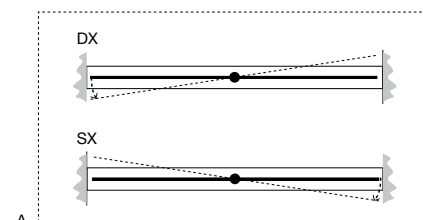
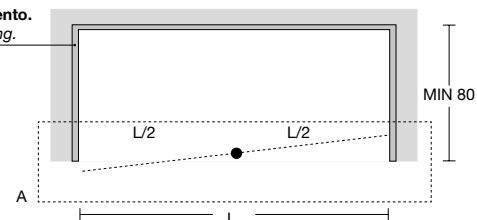

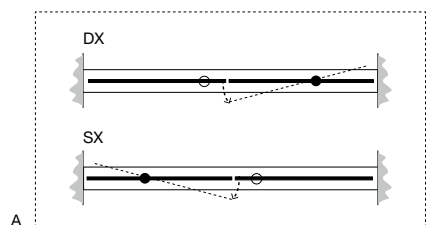
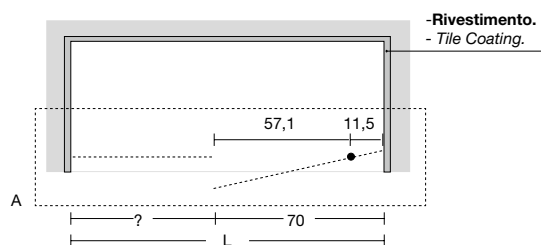
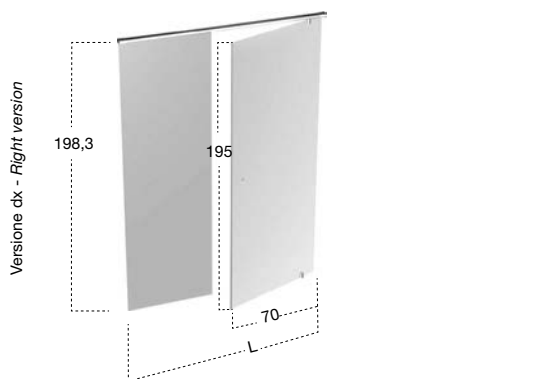

art. BILICO3N

H	da / a - from / to
198,3	L 91 / 117
	118 / 137
	138 / 157
	158 / 177
	178 / 197

Box doccia dx o sx in vetro temperato spess. 8 mm per piatti doccia SUMISURA, ZEROMATT, 00\_XL e 00\_ST tra pareti in nicchia, completo di perno, barra di sostegno e profilo a parete in acciaio inox satinato AISI 304.

Right or left shower enclosure in 8 mm tempered glass for shower tray SUMISURA, ZEROMATT, 00\_XL and 00\_ST within a recessed area, complete with pin, supporting bar and satin stainless steel wall profile AISI 304.

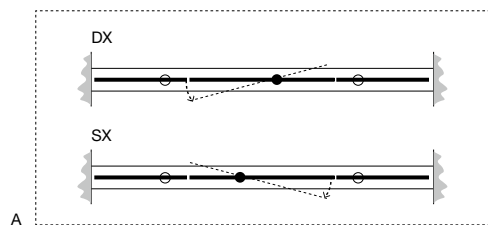
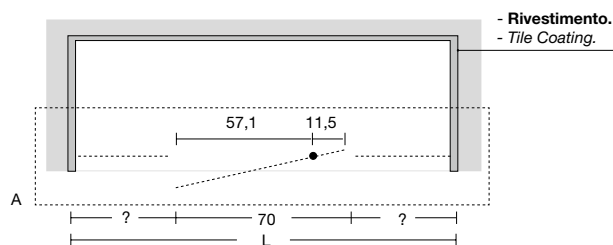
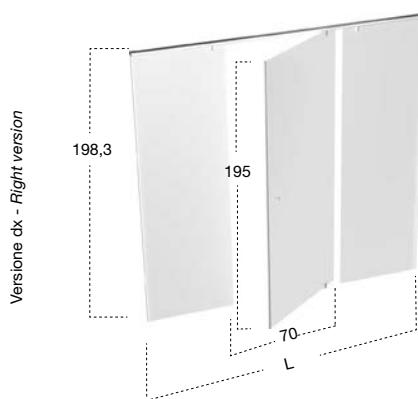

art. BILICO7N

H	da / a - from / to
198,3	L 157 / 177
	178 / 197

Box doccia dx o sx in vetro temperato spess. 8 mm per piatti doccia SUMISURA, ZEROMATT, 00\_XL e 00\_ST tra pareti in nicchia, completo di perno, barra di sostegno e profili a parete in acciaio inox satinato AISI 304.

Right or left shower enclosure in 8 mm tempered glass for shower tray SUMISURA, ZEROMATT, 00\_XL and 00\_ST within a recessed area, complete with pin, supporting bar and wall profiles in satin stainless steel AISI 304.

art.	P
BILICO80AL	67 / 77
BILICO90AL	78 / 90
	da / a - from / to
P	L
67 / 77	89 / 119
	120 / 139
78 / 90	89 / 119
	120 / 139

Box doccia dx o sx in vetro temperato spess. 8 mm per piatti doccia SUMISURA, ZEROMATT, 00\_XL e 00\_ST tra pareti in nicchia, completo di perno e barra di sostegno.

Right or left shower enclosure in 8 mm tempered glass for shower tray SUMISURA, ZEROMATT, 00\_XL and 00\_ST within a recessed area, complete with pin and supporting bar.

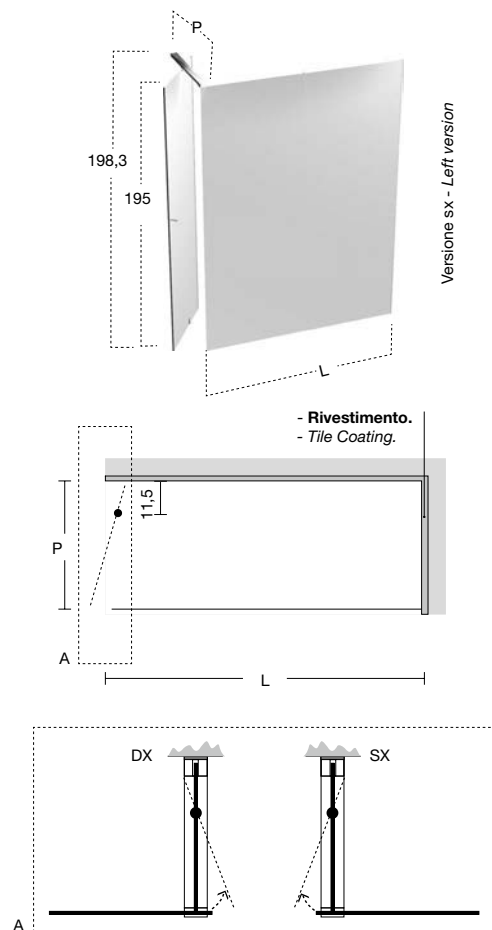

PIATTE BOX DOCCIA  
SHOWER ENCLOSURES

art.	P
BILICO80AF	67 / 77
BILICO90AF	78 / 90
	da / a - from / to
P	L
67 / 77	89 / 119
	120 / 139
	140 / 159
	160 / 179
	180 / 199
78 / 90	89 / 119
	120 / 139
	140 / 159
	160 / 179
	180 / 199

Box doccia dx o sx in vetro temperato spess. 8 mm per piatti doccia SUMISURA, ZEROMATT, 00\_XL e 00\_ST tra pareti in angolo, completo di perno, barra di sostegno e profili a parete in acciaio inox satinato AISI 304.

Right or left shower enclosure in 8 mm tempered glass for shower tray SUMISURA, ZEROMATT, 00\_XL and 00\_ST within a corner, complete with pin, supporting bar and wall profiles in satin stainless steel AISI 304.

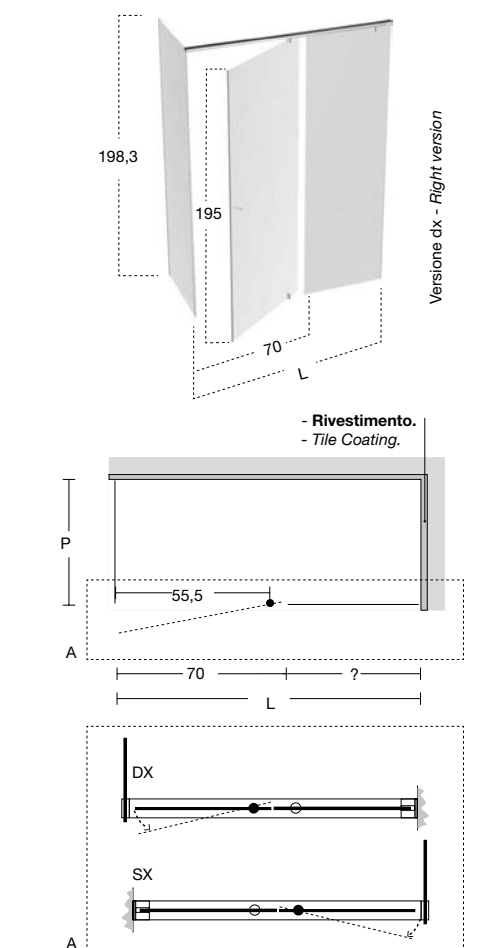

# SUMISURA

\_2017

design  
Nevio  
Tellatin

Sumisura è il piatto doccia sartoriale che esprime alla perfezione, anche nell'elemento apparentemente più semplice, la concezione dell'ambiente bagno contemporaneo di antoniolupi. Un ambiente bagno disegnato e progettato secondo le esigenze di ciascuno, un abito cucito addosso a chi lo vive, un modo di esprimere il proprio io nella stanza più intima della casa. Un pensiero e un modo d'essere che si traduce anche in un elemento tecnico come il piatto doccia. Sumisura è realizzato in Moodlight, il materiale nato dall'evoluzione del Flumood, brevettato da antoniolupi, che riesce a dar vita a superfici ancora più leggere, resistenti e performanti. Sumisura è disponibile in qualsiasi larghezza e profondità nello spessore di 2 cm. La tecnologia utilizzata permette di mantenere la pendenza costante su tutta la superficie mentre la libertà di posizionare lo scarico in punti diversi facilita le operazioni di posa, amplifica le possibilità di personalizzazione e la funzionalità del piatto doccia. Il disegno essenziale della piletta permette di completare un'estetica coordinata per uno stile essenziale e contemporaneo.

*Sumisura is the tailor-made shower tray that expresses perfection, even in the seemingly simplest element, the concept of a contemporary antoniolupi bathroom. A bathroom designed according to the needs of each individual, a dress sewn on to those who live it, a way of expressing one's self in the most intimate room of the house. A thought and a way of being that also translates into a technical element like the shower tray. Sumisura is made in Moodlight, the material created from the evolution of Flumood, patented by antoniolupi, which manages to create even lighter, more durable and powerful surfaces. Sumisura is available in any width and depth in the thickness of 2 cm. The technology used keeps the steady slope across the surface while the freedom to place the drain at different points facilitates installation, all enhances the possibilities of customization and the functionality of the shower tray. The basic design of the drain completes the coordinated aesthetics allowing for an essential and contemporary style.*

MOLTEPLICI PERSONALIZZAZIONI A RICHIESTA  
*MULTIPLE PERSONALIZATIONS ON REQUEST*

Piatto doccia a misura in larghezza e profondità mantenendo la pendenza  
*Custom shower tray in length and depth while maintaining the slope*

Pendenza costante su tutta la superficie  
*Constant slope across the surface*

Resina anti UV e anti ingiallimento  
*Anti UV and anti yellowing resin*

Posizionamento scarico variabile  
*Variable drain position*

Possibilità di inserimento doppio scarico  
*Double drain available*

Bordo rialzato  
*Raised edge*

Tagli e realizzazioni fuori squadra  
*Cuts and out of square production*

Personalizzazioni su dima e su disegno  
*Customizations on template and drawing*

Fresatura per incasso vetro  
*Milling for glass insertion*

Fresatura per installazione a semincasso  
*Milling for semi encased installation*

Personalizzazione con inserimento del nome  
*Customized with name*



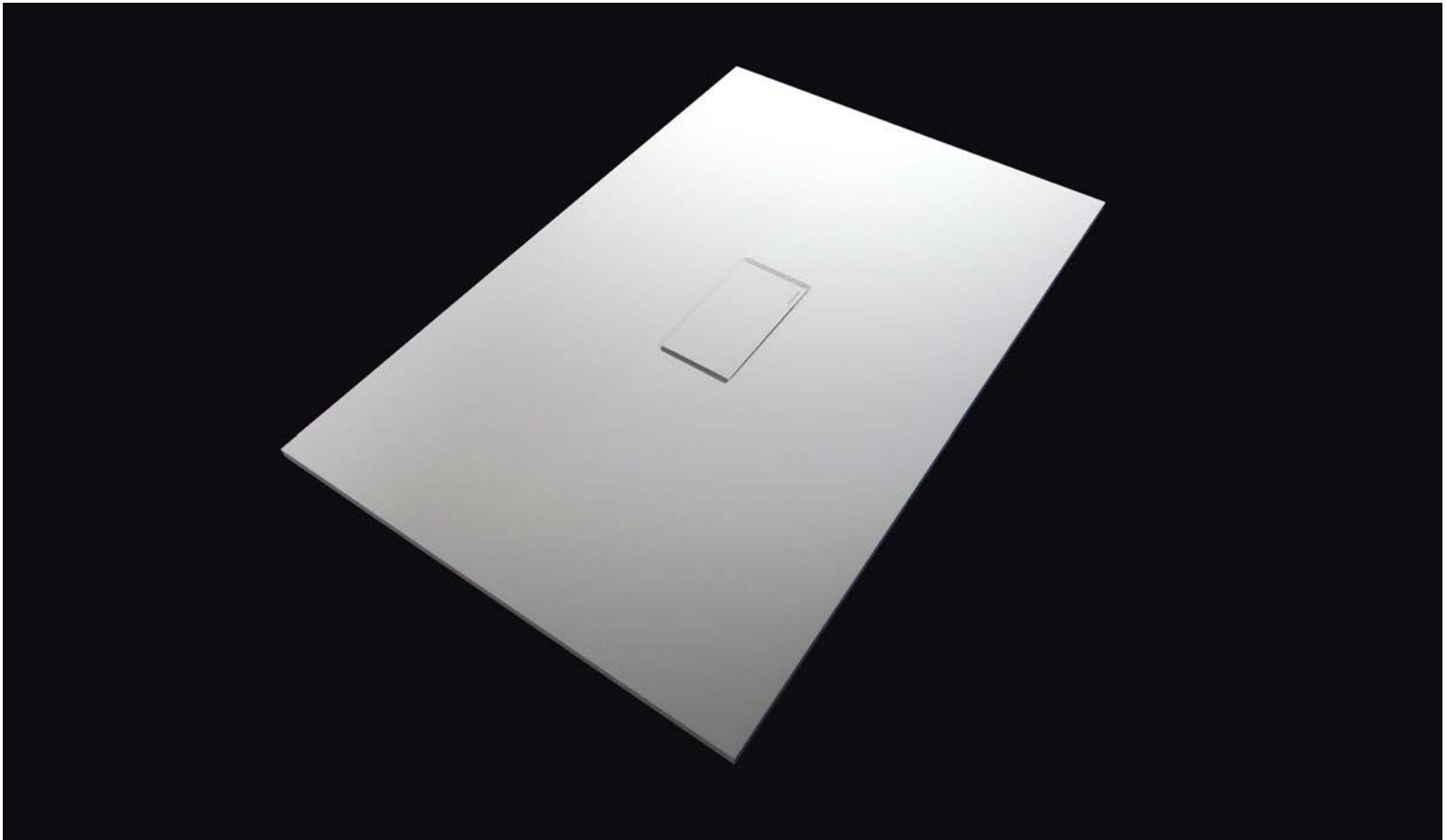

art.	P
SM_80	70 / 80
SM_90	81 / 90
SM_100	91 / 100
SM_110	101 / 110
SM_120	111 / 120



da incasso  
*encased*



da appoggio  
*top mount*

H	L
2	70 / 80
	81 / 90
	91 / 100
	101 / 110
	111 / 120
	121 / 130
	131 / 140
	141 / 150 **
	151 / 160 **
	161 / 170 **
	171 / 180 **
	181 / 190 **
	191 / 200 **
	201 / 210 **
	211 / 220 **

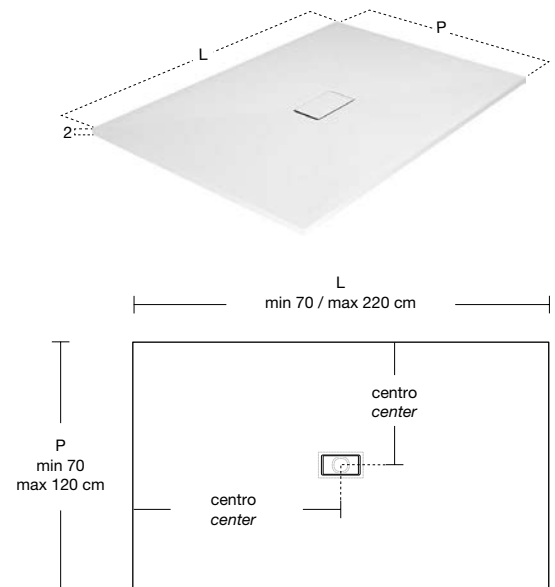

\*\* N.B. Su richiesta è possibile inserire un secondo scarico completo di piletta sifonata.  
P.S. Upon request it is possible to have a second drain complete with trap and plug.

Spess. 2 cm  
Thickness 2 cm



Piatto doccia rettangolare a misura da appoggio (A), da incasso (B) o da semincasso (\*C) in Moodlight spess. 2 cm, completo di sifone e piletta con scarico libero posizionato al centro, con pendenza costante su tutta la superficie.

\* N.B. Lavorazione su richiesta.

Rectangular top mount (A), encased (B) or semi encased (\*C) shower tray in Moodlight 2 cm thick, complete with siphon and open centered drain, with a constant slope across the surface.

\* P.S. Manufacturing upon request.

Per personalizzazioni diverse da quanto indicato si prega di consultare l'azienda / For customization other than that indicated please consult the company

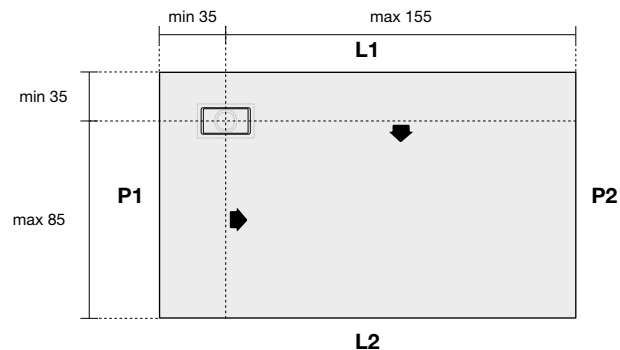

**POSIZIONE SCARICO VARIABILE A RICHIESTA**

La larghezza massima del piatto doccia è di L 220 cm, considerando che la massima estensione di pendenza dal centro piletta è di L 155 cm, è possibile posizionare lo scarico decentrato dove necessita, rispettando le misure minime e massime riportate nello schema.

**DRAIN POSITION VARIABLE ON REQUEST**

The maximum width of the shower tray is L 220 cm, considering the maximum slope from the center of the drain is L 155 cm, so the drain can be positioned where necessary, considering the minimum and maximum measurements reported in the diagram.

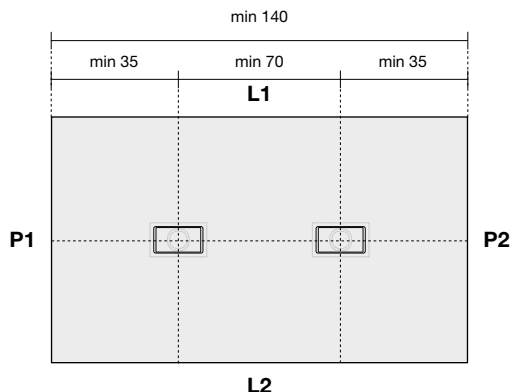

**POSIZIONE DOPPIO SCARICO VARIABILE A RICHIESTA**

Rispettando le misure minime in profondità (P1/P2) min 35 cm riportate nello schema precedente, è possibile posizionare in larghezza (L1/L2) sullo stesso asse un doppio scarico su un L min 140 cm.

**VARIABLE POSITION OF DOUBLE DRAIN UPON REQUEST**

It is possible to include a second drain on a minimum L 140 cm, considering the minimum measurements in depth P1/P2 min 35 cm shown in the diagram and in length L1/L2 along the same axis.





Per personalizzazioni diverse da quanto indicato si prega di consultare l'azienda / For customization other than that indicated please consult the company

**PER OGNI PERSONALIZZAZIONE È NECESSARIO FORNIRE LA DIMA O UN DISEGNO DETTAGLIATO / FOR ANY CUSTOMIZATION YOU MUST PROVIDE THE COMPANY A TEMPLATE OR A DETAILED DRAWING:**

È possibile realizzare fuori squadra, tagli, sagome su disegno (file DXF o DWG) o su dima.

*It is possible to produce out of square, cuts, shapes with a drawing (file in DXF or DWG) or with template.*

ESEMPI DI PERSONALIZZAZIONI / EXAMPLE OF CUSTOMIZATION:

SAGOMA QUADRATA / SQUARE SHAPE

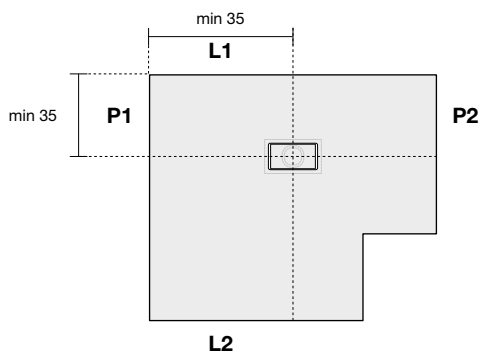

TAGLIO OBLIQUO / OBLIQUE CUTTING

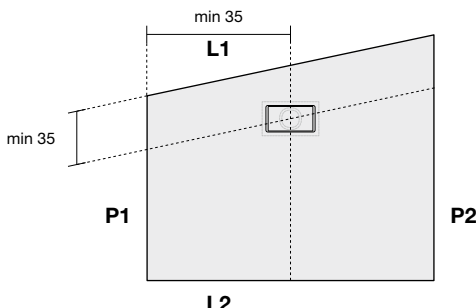

SAGOMA CURVA / CURVED TEMPLATE

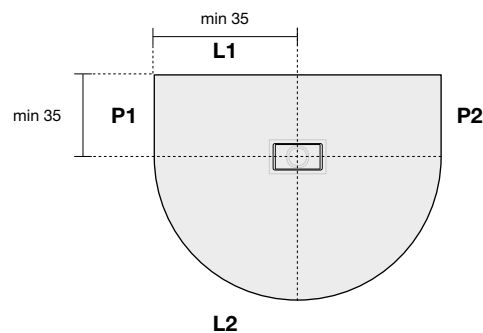

PIATTI BOX DOCCIA  
SHOWER ENCLOSURES

È possibile realizzare lavorazioni personalizzate sui lati del piatto quali, fresature o bordi rialzati.

*On request milling or raised edges can be produced.*

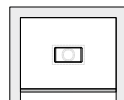

1 lato / 1 side

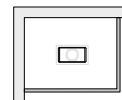

2 lati / 2 sides

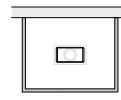

3 lati / 3 sides

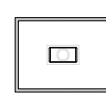

4 lati / 4 sides

ESEMPI DI LAVORAZIONI / EXAMPLES OF WORKMANSHIP:

FRESATURA PER INCASSO VETRO PER OGNI LATO

MILLING FOR GLASS INSERTION ON EACH SIDE

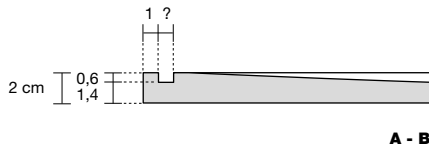

A - B

FRESATURA PER INSTALLAZIONE A SEMINCASSO PER OGNI LATO

MILLING FOR SEMI ENCASED INSTALLATION ON EACH SIDE



C

BORDO RIALZATO PER OGNI LATO

RAISED EDGE ON EACH SIDE

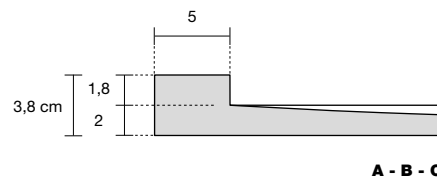

A - B - C

ESEMPI DI INSTALLAZIONE / EXAMPLES OF INSTALLATION:



APPOGGIO / TOP MOUNT

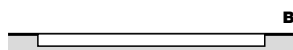

INCASSO / ENCASED

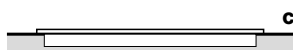

SEMINCASSO / SEMI ENCASED





PIATTE BOX DOCCIA  
SHOWER ENCLOSURES



da incasso  
encased



da appoggio  
top mount

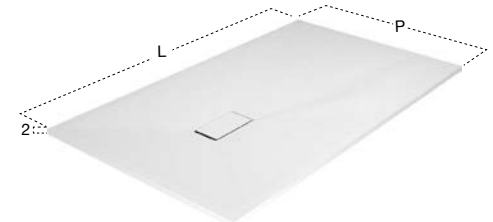

N.B. Per vetri - For shower enclosures.

Art. COMBI20 - Art. COMBI120 - Art. COMBI70 - Art. COMBI80  
Art. COMBI90 - Art. COMBI170 - Art. COMBI180 - Art. COMBI190

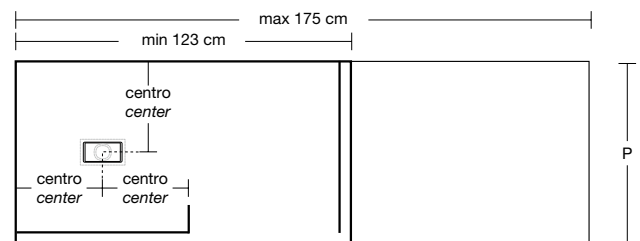

Versione dx - Right version

art.	P
SM_COMBI70	70
SM_COMBI80	80
SM_COMBI90	90
H	L
2	123
	136
	149
	162
	175

Piatto doccia rettangolare dx o sx da appoggio (A), da incasso (B) o da semincasso (\*C) in Moodlight spess. 2 cm, completo di sifone e piletta con scarico libero.

\* N.B. Lavorazione su richiesta.

Right or left rectangular top mount (A), encased (B) or semi encased (\*C) shower tray in Moodlight 2 cm thick, complete with siphon and open drain.

\* P.S. Manufacturing upon request.





vetro extrachiario  
extra-clear glass

art.

COMBI1

Asta distanziale in acciaio inox satinato AISI 304, per fissaggio a parete vetri box doccia  
Art. COMBI20 e Art. COMBI120.

*Satin stainless steel AISI 304 shower bar for wall to glass shower cabin fitting Art. COMBI20 and Art. COMBI120.*

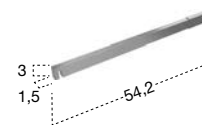

art. H

COMBI20 195

COMBI120 220

Per piatti doccia  
For shower trays

P	L	L
20	66	123
	79	136
	92	149
	105	162
	118	175

Box doccia dx o sx in vetro temperato spess. 8 mm solo per piatti doccia Art. SM\_COMBI tra pareti in nicchia, completo di profilo a parete.

*Right or left shower enclosure in 8 mm tempered glass only for shower trays Art. SM\_COMBI within a recessed area complete with wall profiles.*

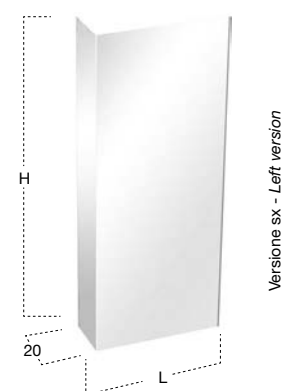

PIATTE BOX DOCCIA  
SHOWER ENCLOSURES

art. H P

COMBI70 195 70

COMBI80 195 80

COMBI90 195 90

COMBI170 220 70

COMBI180 220 80

COMBI190 220 90

Per piatti doccia  
For shower trays

P	L	P	L
67,5 / 77,5 / 87,5	120,5	70 / 80 / 90	123
	133,5		136
	146,5		149
	159,5		162
	172,5		175

Box doccia dx o sx in vetro temperato spess. 8 mm solo per piatti doccia Art. SM\_COMBI tra pareti in angolo, completo di profili a parete e distanziale in acciaio inox satinato AISI 304.

*Right or left shower enclosure in 8 mm tempered glass only for shower trays Art. SM\_COMBI within a corner complete with wall profile and satin stainless steel AISI 304 bar.*

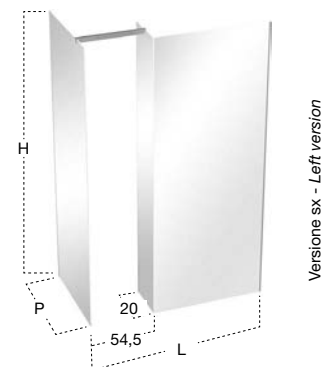

Versione sx - Left version



Vetro extrachiaro  
Extra-clear glass

Vetro acidato  
Acid glass

Vetro bronzo  
Bronze glass

Vetro fumé  
Fumé glass

Vetro riflettente fumé  
Reflective fumé glass



PIATTI BOX DOCCIA  
SHOWER ENCLOSURES

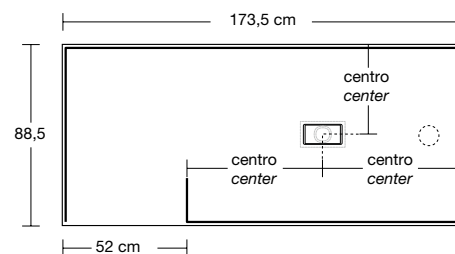

Versione sx - Left version

P	H	L	art.
88,5	2	173,5	SM_ISOLA

Piatto doccia rettangolare dx o sx da appoggio (A), da incasso (B) o da semincasso (\*C) in Moodlight spess. 2 cm, completo di sifone e piletta con scarico libero.

Solo per box doccia Art. ISOLA88.

N.B. Su richiesta è possibile realizzare foro per soffione Art. SHAWA2.

Right or left rectangular top mount (A), encased (B) or semi encased (\*C) shower tray in Moodlight 2 cm thick, complete with siphon and open drain.

Only for shower enclosures Art. ISOLA88.

P.S. Showerhead hole Art. SHAWA2 upon request.

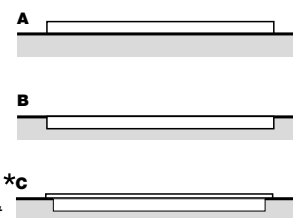

\* Lavorazione su richiesta - Manufacturing upon request

P	H	L	art.
86,3	197,5	171,3	ISOLA88

Box doccia dx o sx ad isola in vetro temperato spess. 8 mm solo per piatto doccia Art. SM\_ISOLA completo di distanziale in acciaio inox satinato AISI 304.

Right or left freestanding shower enclosure in tempered glass 8 mm thick only for shower trays Art. SM\_ISOLA, complete with satin stainless steel AISI 304 bar.

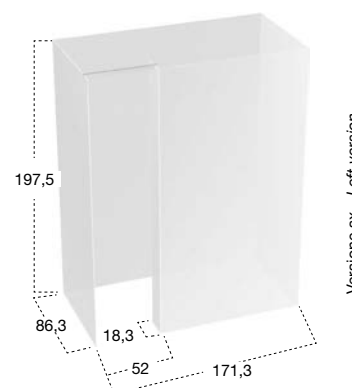

Versione sx - Left version





Vetro extrachiaro  
Extra-clear glass

Vetro acidato  
Acid glass

Vetro bronzo  
Bronze glass

Vetro fumé  
Fumé glass

Vetro riflettente fumé  
Reflective fumé glass

## PENISOLA design Nevio Tellatin



PIATTE BOX DOCCIA  
SHOWER ENCLOSURES

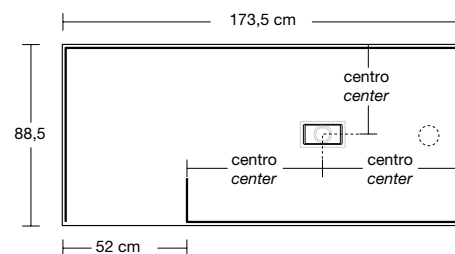

Versione sx - Left version

P	H	L	art.
88,5	2	173,5	SM_PENISOLA

Piatto doccia rettangolare dx o sx da appoggio (A), da incasso (B) o da semincasso (\*C) in Moodlight spess. 2 cm, completo di sifone e piletta con scarico libero.

Solo per box doccia Art. PENISOLA88.

N.B. Su richiesta è possibile realizzare foro per soffione Art. SHAWA2.

Right or left rectangular top mount (A), encased (B) or semi encased (\*C) shower tray in Moodlight 2 cm thick, complete with siphon and open drain.

Only for shower enclosures Art. PENISOLA88.

P.S. Showerhead hole Art. SHAWA2 upon request.

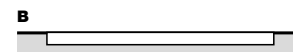

\* Lavorazione su richiesta - Manufacturing upon request

P	H	L	art.
86,3	197,5	171,3	PENISOLA88

Box doccia dx o sx a penisola in vetro temperato spess. 8 mm solo per piatto doccia Art. SM\_PENISOLA, completo di profili a parete e distanziale in acciaio inox satinato AISI 304.

Right or left shower enclosure in tempered glass 8 mm thick only for shower trays Art. SM\_PENISOLA, complete with wall profiles and satin stainless steel AISI 304 bar.

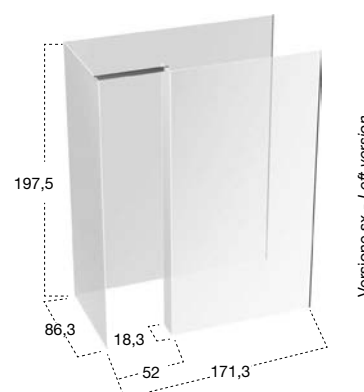

Versione sx - Left version





PIATTE BOX DOCCIA  
SHOWER ENCLOSURES

H	P	L	art.
3	70	90	ZEROMATT7090
		100	ZEROMATT70100
		120	ZEROMATT70120
		140	ZEROMATT70140

H	P	L	art.
3	80	80	ZEROMATT8080
		100	ZEROMATT80100
		120	ZEROMATT80120
		140	ZEROMATT80140
		160	ZEROMATT80160

H	P	L	art.
3	90	90	ZEROMATT9090
		100	ZEROMATT90100
		120	ZEROMATT90120
		140	ZEROMATT90140
		160	ZEROMATT90160

H	P	L	art.
3	100	100	ZEROMATT100100
		120	ZEROMATT100120
		140	ZEROMATT100140
		160	ZEROMATT100160

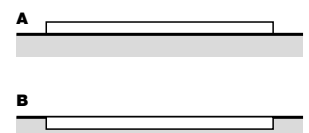
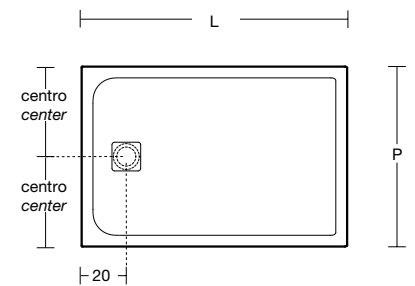
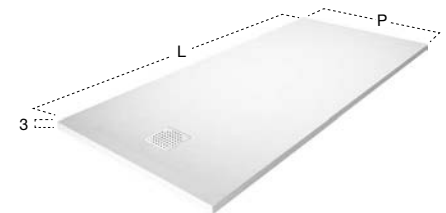

Piatto doccia rettangolare da appoggio (A) o da incasso (B) in Ceramilux in finitura opaca, completo di sifone e piletta con scarico libero.

Rectangular top mount (A) or encased (B) shower tray in Ceramilux in matt finish, complete with siphon and open drain.





PIATTE BOX DOCCIA  
SHOWER ENCLOSURES

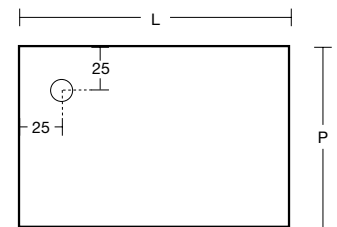
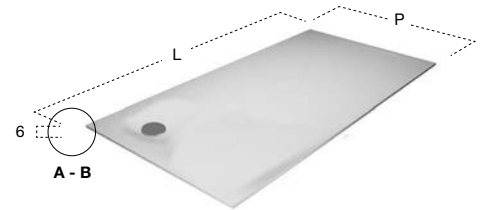

Versione dx - Right version

H	P	L	art.
6	70	90	00_ST1
	80	110	00_ST2
	80	120	00_ST3
	80	140	00_ST4
	90	90	00_ST5
	90	140	00_ST6

Piatto doccia rettangolare dx o sx da appoggio (A) o da incasso (B) termoformato in Corian, con supporto poliuretano completo di sifone e piletta con scarico libero.

Right or left rectangular top mount (A) or encased (B) shower tray completely in Corian with polyurethane support complete with siphon and open drain.

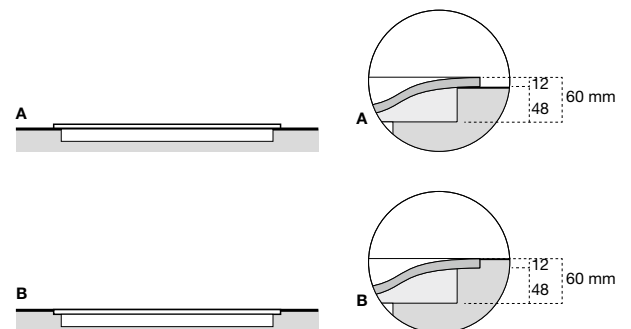





PIATTE BOX DOCCIA  
SHOWER ENCLOSURES

art.	P
00_XL70	70
00_XL80	80
00_XL90	90
00_XL100	100
00_XL110	110
00_XL120	120
00_XL130	130
00_XL140	140

H	L
6	80/90
	91/100
	101/110
	111/120
	121/130
	131/140
	141/150
	151/160
	161/170
	171/180
	181/190 **
	191/200 **
	201/210 **
	211/220 **
	221/230 **
	231/240 **
	241/250 **
	251/260 **
	261/270 **
	271/280 **
	281/290 **
	291/300 **

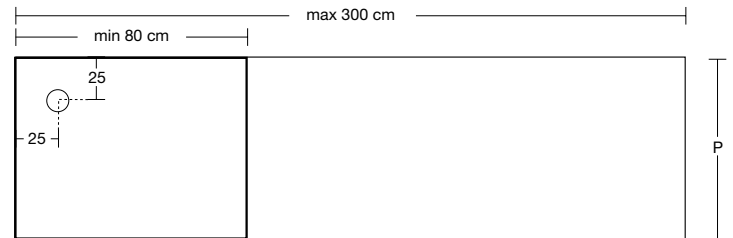
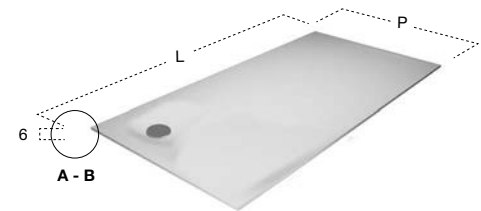

Versione dx - Right version

\*\* N.B. Su richiesta è possibile inserire un secondo scarico completo di piletta sifonata. (La pendenza sarà divisa per due).  
P.S. Upon request it is possible to have a second drain complete with trap and plug (the slope will be divided in half).

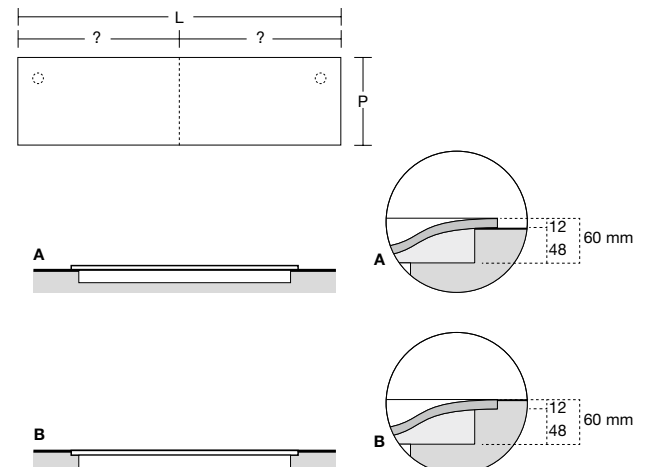

Piatto doccia rettangolare dx o sx a misura, da appoggio (A) o da incasso (B) termoformato in Corian, con supporto poliuretano completo di sifone e piletta con scarico libero.

Right or left rectangular top mount (A) or encased (B) shower tray completely in Corian with polyurethane support complete with siphon and open drain.

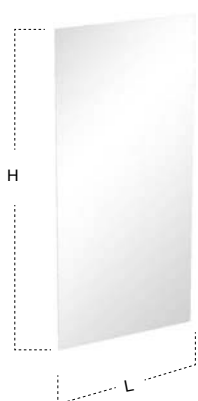

H	L	art.
195	77,5	VB13
	87,5	VB14
	97,5	VB15
	107,5	VB16
	117,5	VB17
220	127,5	VB18
	137,5	VB19
	77,5	VB3
	87,5	VB4
	97,5	VB5
	107,5	VB6
	117,5	VB7
	127,5	VB8
	137,5	VB9

Vetro temperato spess. 8 mm solo per piatti doccia SUMISURA, ZEROMATT, 00\_XL e 00\_ST.

8 mm tempered glass only for shower trays SUMISURA, ZEROMATT, 00\_XL and 00\_ST.



Ø	L	art.	Per piatti doccia
			For shower trays
			P
2	64,4	POLE1	70
	74,4	POLE2	80
	84,4	POLE3	90
	94,4	POLE4	100
	104,4	POLE5	110

Asta distanziale per vetri box doccia in acciaio inox satinato AISI 304.

*Satin stainless steel AISI 304 shower bar for glass shower.*

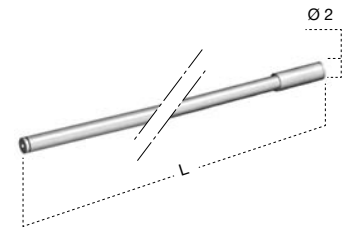

H	P	L	art.
195	2,8	1,8	PEG4
220	2,8	1,8	PEG3

Profilo in acciaio inox satinato AISI 304 per il fissaggio a parete dei vetri box doccia Art. VB.

*Glass wall fixing profiles in satin stainless steel AISI 304 for shower glass Art. VB.*

PEG design Nevio Tellatin

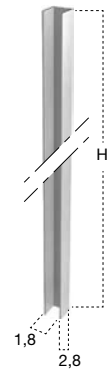

PIATTI BOX DOCCIA  
SHOWER ENCLOSURES



vetro extrachiario  
*extra-clear glass*



vetro acidato  
*acid glass*



vetro bronzo  
*bronze glass*



vetro fumé  
*fumé glass*



vetro riflettente fumé  
*reflective fumé glass*



# SANITARI *SANITARY-WARE*

# KOMODO / CABO

SISTEMA "LESS\_RING"

*"LESS\_RING" FLUSHING SYSTEM*

Il vaso in ceramica, utilizza il sistema LESS\_RING che oltre a garantire una perfetta pulizia del volume interno e massima capacità di sciacquo, dona all'insieme un'immagine finale gradevole. Il movimento circolare consente di lavare in modo preciso e senza spruzzi tutta la superficie, contrariamente a quanto avveniva con i normali vasi con la brida, per un'igiene del 100%.

*The ceramic water closet, uses the LESS\_RING system that ensures perfect internal cleaning and a maximum ability to rinse. The circular movement allows to wash in a precise manner and without splashing, contrary to what happens with standard water closets with a rim, to assure 100% hygiene.*



SANITARI  
SANITARY - WARE

# FLAT

\_2017

design

Daniel Debiasi

Federico Sandri



KOMODO / CABO

Sedile con sistema di sganciamento rapido.  
*Seat and cover with quick release system.*

Sedile con chiusura rallentata "soft-close".  
*Seat and cover with soft closing hinges.*



# KOMODO

\_2011

design  
AL Studio







SANITARI  
SANITARY - WARE

# KOMODO



SISTEMA "LESS\_RING" / "LESS\_RING" FLUSHING SYSTEM

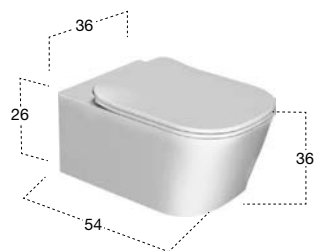

H	P	L	art.	
26	54	36	KOMODO1	Ceramica Lucida / High gloss Ceramic
26	54	36	KOMODO3	Ceramica Satinata / Satin Ceramic

Vaso in ceramica lucida o satinata, sospeso con scarico a parete e sistema senza brida, completo di sedile avvolgente FLAT con sistema di sganciamento rapido, realizzato in resina termoindurente con chiusura rallentata "soft-close".

*High gloss or satin suspended ceramic water closet with wall drain and washdown rimless flushing, complete with seat and cover FLAT made of thermosetting resin, quick release system and soft closing hinges.*

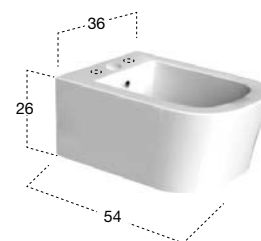

H	P	L	art.	
26	54	36	KOMODO2	Ceramica Lucida / High gloss Ceramic
26	54	36	KOMODO4	Ceramica Satinata / Satin Ceramic

Bidet monoforo in ceramica lucida o satinata, sospeso con scarico a parete (predisposto per 3 fori rubinetteria).

*High gloss or satin suspended ceramic bidet with wall drainage and single tap hole (prepared for 3 tap hole).*

# CABO

\_2017

design

Daniel Debiasi

Federico Sandri

Una forma scultorea fatta di superfici sinuose e continue, una silhouette raffinata che esalta le potenzialità del materiale ceramico ed esprime una sensazione di leggerezza sia nella versione sospesa che in quella a terra. Cabo è la collezione di sanitari che associa estetica sofisticata e massima igiene, grazie all'assenza nel wc della brida tradizionale.

Il vaso in ceramica della collezione Cabo, utilizza il sistema LESS\_RING che oltre a garantire una perfetta pulizia del volume interno e massima capacità di sciacquo, dona all'insieme un'immagine finale gradevole. Il movimento circolare consente di lavare in modo preciso e senza spruzzi tutta la superficie, contrariamente a quanto avveniva con i normali vasi con la brida, per un'igiene del 100%.

*A sculptural form made of sinuous and continuous surfaces, a refined silhouette that enhances the potential of ceramic material and expresses a feeling of lightness available in both the suspended version and in the floor version. Cabo is the collection of sanitary ware that combines sophisticated aesthetics and maximum hygiene thanks to the absence of the traditional toilet rim. The ceramic water closet, from the Cabo collection, uses the LESS\_RING system that ensures perfect internal cleaning and a maximum ability to rinse. The circular movement allows to wash in a precise manner and without splashing, contrary to what happens with standard water closets with a rim, to assure 100% hygiene.*



SANITARI  
SANITARY - WARE





SANITARI  
SANITARY - WARE



SISTEMA "LESS\_RING" / "LESS\_RING" FLUSHING SYSTEM



H	P	L	art.	
26	54	36,6	CAB01	Ceramica Lucida / High gloss Ceramic
26	54	36,6	CAB03	Ceramica Satinata / Satin Ceramic

Vaso in ceramica lucida o satinata, sospeso con scarico a parete e sistema senza brida, completo di sedile avvolgente FLAT con sistema di sganciamento rapido, realizzato in resina termoindurente con chiusura rallentata "soft-close".

*High gloss or satin suspended ceramic water closet with wall drain and washdown rimless flushing, complete with seat and cover FLAT made of thermosetting resin, quick release system and soft closing hinges.*



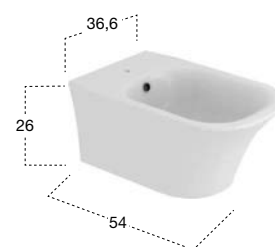

H	P	L	art.	
26	54	36,6	CABO2	Ceramica Lucida / High gloss Ceramic
26	54	36,6	CABO4	Ceramica Satinata / Satin Ceramic

Bidet monoforo in ceramica lucida o satinata, sospeso con scarico a parete.

*High gloss or satin suspended ceramic bidet with wall drainage and single tap hole.*



SISTEMA "LESS\_RING" / "LESS\_RING" FLUSHING SYSTEM



H	P	L	art.	
42	54	36,6	CAB021	Ceramica Lucida / High gloss Ceramic
42	54	36,6	CAB023	Ceramica Satinata / Satin Ceramic

Vaso in ceramica lucida o satinata, da terra con scarico a pavimento o a parete e sistema senza brida, completo di sedile avvolgente FLAT con sistema di sganciamento rapido, realizzato in resina termoindurente con chiusura rallentata "soft-close".

*High gloss or satin freestanding ceramic water closet with floor or wall drain and washdown rimless flushing, complete with seat and cover FLAT made of thermosetting resin, quick release system and soft closing hinges.*



H	P	L	art.	
42	54	36,6	CAB022	Ceramica Lucida / High gloss Ceramic
42	54	36,6	CAB024	Ceramica Satinata / Satin Ceramic

Bidet monoforo in ceramica lucida o satinata, da terra con scarico a parete (predisposto per 3 fori rubinetteria).

*High gloss or satin freestanding ceramic bidet with wall drainage and single center tap hole (prepared for 3 tap hole).*

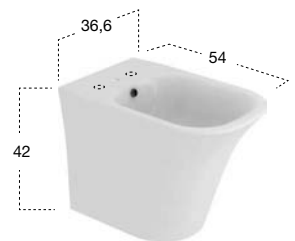

# RAPIDO

\_2018

design  
GI-RA

Essenziale, rigoroso, pulito nel suo minimalismo assoluto per integrarsi alla perfezione dal punto di vista stilistico con gli altri accessori che compongono l'ambiente bagno contemporaneo di antoniolupi. Una presenza discreta ma elegante allo stesso tempo, un oggetto funzionale che diventa un elemento della composizione. Materia e geometria sono protagoniste del nuovo scopino Rapido disegnato da GI-RA Design. Una perfetta forma cilindrica in acciaio inox satinato nella quale si inserisce un'asta sottile, sempre in acciaio con l'inedita spatola in silicone che garantisce la massima igiene oltre che conferire una forma slanciata all'insieme. Un coordinamento materico assoluto, un segno chiaro e lineare per un oggetto flessibile che può essere posizionato a terra o sospeso per amplificare la funzionalità.

*Essential, rigorous, clean in its absolute minimalism to integrate perfectly from the stylistic point of view with the other accessories that make up the contemporary bathroom of antoniolupi. A discreet but elegant presence at the same time, a functional object that becomes an element of the composition. Matter and geometry are the protagonists of the new Rapido brush designed by GI-RA Design. A perfect cylindrical shape in satin stainless steel in which inserted is a thin steel rod with the new silicone spatula that guarantees maximum hygiene as well as giving a slender shape. An absolute coordination of materials, a clear and linear sign for a flexible object that can be placed on the floor or suspended to amplify functionality.*



SANITARI  
SANITARY - WARE





RAPIDO



H	Ø	art.
43,5	8	RAPIDO1

Porta scopino da appoggio in acciaio inox satinato AISI 304.  
*Freestanding toilet brush and holder in satin stainless steel AISI 304.*





H	Ø	art.
43,5	4	RAPIDO2

Porta scopino con supporto a parete in acciaio inox satinato AISI 304.

*Wall hanging toilet brush and holder in satin stainless steel AISI 304.*



# ONDA

\_2010

design

Nevio

Tellatin



Una linea che rompe gli equilibri lasciando immutata la sensazione di armonia, un segno che esprime eleganza senza perdere la funzionalità dell'insieme, un tratto deciso e dinamico che si sviluppa con continuità e si integra perfettamente, sovrapponendosi, all'essenzialità di una geometria pura. Organicità ed essenzialità convivono in un elemento tecnico che diventa espressivo. Onda è la placca di comando in acciaio inox per cassetta wc nella quale si esprime tutta la pulizia formale di antoniolupi, l'attenzione ai dettagli, la qualità dei materiali e delle superfici riservata anche agli accessori. Un disegno semplice ma allo stesso tempo innovativo, un equilibrio proporzionale perfetto che trasmette immediatamente la funzione per la quale è stata pensata senza per questo ridurla a mero elemento tecnico. Un gesto semplice, un tasto unico basculante che assicura una piacevolezza tattile che diventa ergonomia e facilità d'uso. Onda è disponibile nella finitura lucida o satinata.

*A harmonious item, a sign that expresses elegance without losing its function, a decisive and dynamic trait that develops continuously and seamlessly integrating perfectly within the space, overlapping essence of pure geometry. Organic and simplicity coexist in a technical element which becomes meaningful. Onda is a flush plate in stainless steel for water cisterns which expresses the formal clean lines of antoniolupi, attention to detail, the quality of materials, also reserved for accessories.*

*A simple design but at the same time innovative, a perfect proportional balance that immediately transmits the function for which it was conceived without reducing it to a mere technical element. A simple gesture, a single button that provides a pleasing touch that becomes ergonomic and easy to use. Onda is available in polished or in a satin finish.*



H	L	art.
15,5	27	ONDA

Placca di comando per cassetta wc a tasto unico basculante per il risciacquo a due quantità in acciaio inox AISI 304 satinato, lucido o grafite, completa di kit adattatore di montaggio.

*Mechanical dual flush plate for toilet cisterns in satin, polished stainless steel AISI 304 or graphite complete with installation adapter kit.*

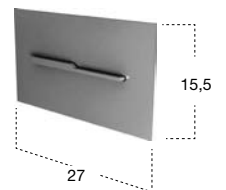

# TENSO / CARTATENSO

\_2017

design

GI-RA

Modello e design registrato, brevetto depositato  
*Registered model and design, patent filed*

## TENSO

Un nuovo concetto di idroscopino in acciaio inox, con la sicurezza della doppia chiusura: ruotando la placchetta di 90°, contemporaneamente si apre l'acqua e la finestra che lo nasconde con il suo flessibile... basta ruotare la testina per dare il via al getto.

Una volta ruotata di nuovo la testina e riposto velocemente l'idroscopino nel suo alloggiamento, ruotando la placchetta, chiudiamo insieme, con un unico gesto, acqua e finestra.

*A new concept of hydrobrush in satin stainless steel with double locking security: by rotating the plate 90°, water and the window that contains it with a flexible hose will open simultaneously... simply rotate the head for water flow.*

*Once rotated the head again and stowed quickly away, rotate the plate and close with one single step, water and window.*

## CARTATENSO

Doppia funzione in un unico vano per un complemento che uniforma ingombri e incassi per conferire un'immagine pulita e omogenea alla parete. Cartatenso racchiude in sé porta rotolo e idroscopino da incasso in acciaio inox satinato AISI 304 con doppio sistema di apertura e chiusura acqua e flessibile di 85 cm ad alta pressione.

La placca che ospita le due funzioni propone un'estetica essenziale e rigorosa, grazie a una superficie satinata che ben dialoga con gli altri materiali che compongono l'ambiente bagno. Un elemento che testimonia ancora una volta l'attenzione di antoniolupi ai dettagli, agli elementi funzionali, anche verso gli accessori che sembrano essere secondari ma che in realtà fanno la differenza, definendo uno stile che è in realtà un modo d'essere.

*Dual function in a single room that brings together dimensions and encasing to give a clean image and smooth wall. Cartatenso embodies a toilet roll holder and built in hydrobrush in brushed stainless steel AISI 304 with dual system of opening and closing and high pressure flexible hose of 85 cm.*

*The plate that houses the two functions proposes an essential and rigorous aesthetic, with a satin surface that interacts well with the other materials that make up the bathroom. An element which demonstrates once again the attention of antoniolupi to detail, the functional elements, including the accessories that appear to be minor but actually make a difference, by defining a style which is actually a lifestyle.*



SANITARI  
SANITARY - WARE





SANITARI  
SANITARY - WARE

H	P	L	art.
66	8	33	TENSO

Idroscopino da incasso in acciaio inox satinato o lucido AISI 304 con doppio sistema di apertura e chiusura acqua e flessibile 85 cm ad alta pressione.

*Encased hydrobrush in satin or polished stainless steel AISI 304 with double opening and closing water system and high pressure flexible hose 85 cm.*

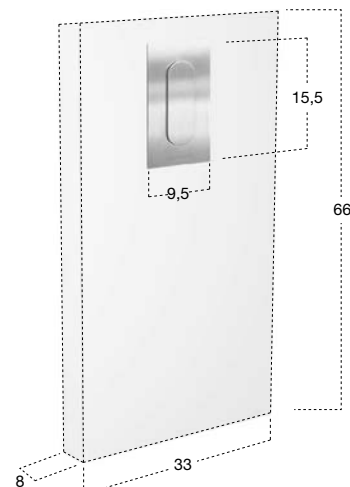







SANITARI  
SANITARY - WARE



H	P	L	art.
66	8	33	CARTATENSO

Porta carta e idroscopino da incasso in acciaio inox satinato o lucido AISI 304 con doppio sistema di apertura e chiusura acqua e flessibile di 85 cm ad alta pressione.

*Encased hydrobrush cleaner and paper roll holder in satin or polished stainless steel AISI 304 with double opening and closing water system and high pressure flexible hose 85 cm.*

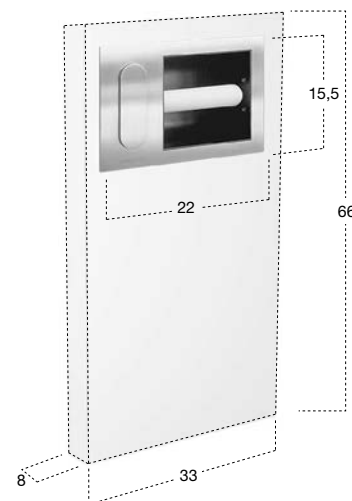

# INTENSO / CARTAINTENSO

\_2018

design  
GI-RA



INTENSO

CARTAINTENSO



SANITARI  
SANITARY - WARE

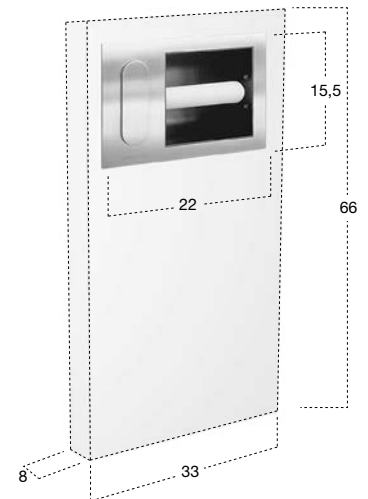
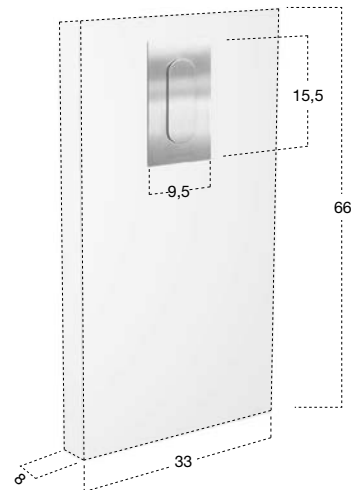

H	P	L	art.
66	8	33	INTENSO

H	P	L	art.
66	8	33	CARTAINTENSO

Doccetta igienica da incasso in acciaio inox satinato o lucido AISI 304, con doppio sistema di apertura e chiusura acqua e flessibile 85 cm, con getto nebulizzato.

*Encased hygienic shower in satin or polished stainless steel AISI 304, with double opening and closing water system and high pressure flexible hose 85 cm, with nebulized jet.*

Porta carta e doccetta igienica da incasso in acciaio inox satinato o lucido AISI 304 con doppio sistema di apertura e chiusura acqua e flessibile di 85 cm, con getto nebulizzato.

*Encased hygienic shower and paper roll holder in satin or polished stainless steel AISI 304 with double opening and closing water system and high pressure flexible hose 85 cm, with nebulized jet.*

# GIRO\_SCHIZZO / GIRO\_INTENSO

\_2017

design  
GI-RA



Un elemento tecnico che assume una valenza estetica nella definizione dell'immagine complessiva dello spazio, un complemento che propone una forma compatta e rigorosa nella quale le geometrie degli elementi che lo compongono, si integrano con equilibrio ed eleganza discreta. GIRO\_SCHIZZO è l'idroscopino da esterno in acciaio satinato AISI 316/L, completo di supporto e presa d'acqua a parete, con flessibile 100 cm ad alta pressione.

GIRO\_SCHIZZO non si nasconde nella parete, ma rivela sin da subito la propria presenza, perché anche gli elementi funzionali possano assumere una connotazione formale. La funzionalità rimane però l'obiettivo primario. Grazie a un getto potente e concentrato, permette di assolvere alle funzioni di pulizia in modo ottimale.

*A technical element that assumes value in the overall aesthetics when defining space, a complement which proposes a compact and rigorous form in which the geometries of the elements that compose it are integrated with balance and discreet elegance. GIRO\_SCHIZZO is a wall mounted hydrobrush in brushed steel AISI 316/L, complete with support and high pressure flexible hose 100 cm. GIRO\_SCHIZZO is not hidden in the wall but reveals its presence because even functional elements may take on a formal connotation. The functionality, however, remains the primary objective. With a powerful and concentrated jet optimal cleaning results are obtained.*



P	L	art.
9	6,5	GIRO_INTENSO

Doccetta igienica in acciaio inox satinato AISI 316/L con apertura acqua (2), supporto con chiusura integrata di sicurezza (1) e flessibile 100 cm, con getto nebulizzato.

*Hygienic shower with nebulizer jet in satin stainless steel AISI 316/L, water opening system (2), support with integrated security closure (1) and hose 100 cm.*



P	L	art.
9	6,5	GIRO_SCHIZZO

Idroscopino in acciaio inox satinato AISI 316/L con apertura acqua (2), supporto con chiusura integrata di sicurezza (1) e flessibile 100 cm ad alta pressione.

*Satin stainless steel AISI 316/L hydrobrush with water opening system (2), support with integrated security closure (1) and high pressure hose 100 cm.*

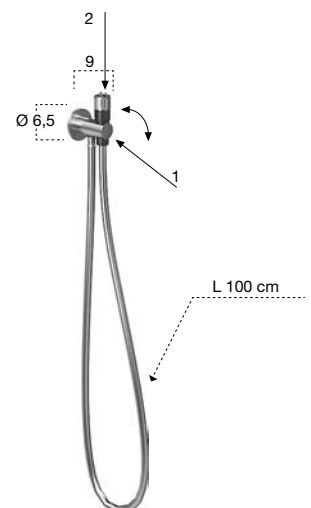



TERMOARREDI  
*DESIGNER RADIATORS*

# BITLIGHT / BIT

\_2013

design

Brian

Sironi

BITLIGHT e BIT sono monoliti realizzati al 100% in alluminio riciclato. Termoarredi facilmente inseribili in qualunque ambiente, personalizzabili con la stessa verniciatura della parete o in contrasto di colore. Le lievi sporgenze in sequenza ritmica, determinano un leggero gioco di ombre che li rendono scultorei, bassorilievi contemporanei, una citazione delle superfici monocromatiche in rilievo delle avanguardie minimaliste della seconda metà del '900.

*BITLIGHT and BIT are monoliths made of 100% recycled aluminum. Versatile designer radiators suitable in any space. The product can be customizable with the same coating as the wall or in a contrasting colour. The light protrusions in a rhythmic sequence create a game of shadows giving certain sculptural features as if it were a contemporary bas-relief, a quote of monochromatic surfaces typical of the avant-garde movement in the late '900s.*

## BITLIGHT

La famiglia dei termoarredi BIT si arricchisce della versione BITLIGHT, dello spessore di soli 7 cm. BITLIGHT è proposto nella versione ad acqua e in quella elettrica, è disponibile in tre altezze, 120 - 150 - 180 cm è più leggero, ha la parte elettrica a secco, resa termica aumentata, sonda elettrica locale, elettronica integrata, è gestibile anche con "fil pilote". Disponibile nella finitura Brown goffrato o colorato goffrato come da cartella colori.

*BIT radiators are enhanced with the BITLIGHT version only 7 cm thick. BITLIGHT is available in the water or electrical version in three heights 120 – 150 – 180 cm and much lighter, dry electricity, heat output increased, local electrical power probe, integrated electronics commanded with "fil pilote" Available in finishes embossed Brown or coloured as per our colour sample.*





TERMOARREDI  
DESIGNER RADIATOR

BIT è realizzato in alluminio 100% riciclato, con un risparmio del 95% rispetto alla produzione di alluminio primario ricavato in natura dalla bauxite.

*BIT is entirely made of recycled aluminium with a saving of 95% compared to the standard production made with primary aluminium naturally extracted from bauxite.*

 **AL > 95% AL**

L'alluminio pesa circa un terzo dell'acciaio (2,7 vs. 7,9 kg/dm<sup>3</sup>). L'alluminio è riciclabile all'infinito mantenendo inalterate le proprie caratteristiche.

*The weight of aluminium is one third if compared with steel (2,7 vs. 7,9 Kg/dm<sup>3</sup>). Aluminium can be recycled perpetually maintaining its characteristics.*

**AL =  AL**

Da 3 lattine di alluminio si ottiene un paio di occhiali, da 37 lattine una caffettiera, da 70 lattine una padella, DA 200 UN RADIATORE DI DESIGN, da 800 una bicicletta.

L'alluminio riciclato permette di risparmiare 4 alberi per ogni tonnellata di alluminio prodotta.

*From 3 cans of aluminium we obtain a pair of glasses, from 37 cans a coffee machine, from 70 cans a pan, FROM 200 CANS A DESIGNER RADIATOR, from 800 a bicycle. Recycled aluminium allows to save 4 trees for each ton of aluminium.*



Nel mondo si producono ca. 60 milioni di ton/anno di alluminio. Ca. il 33% della quantità di alluminio prodotta è ricavata da rottami (alluminio secondario). Un albero con una vita media di 30 anni è in grado di riconvertire ca. 700 kg di CO<sub>2</sub>, per ogni tonnellata di alluminio prodotta da rottame si evita l'emissione in atmosfera di 2000 kg di CO<sub>2</sub>.

*Every year around 60 million tons of aluminium are produced worldwide. About 33% of the quantity of aluminium produced is extracted from scrap metal (secondary aluminium). A tree with an average life of 30 years is able to convert around 700 kg. of CO<sub>2</sub>. For each ton of aluminium produced from scrap metal, an emission of 2000 kg. of CO<sub>2</sub> can be avoided.*

Ogni tonnellata di alluminio prodotto da rottame produce ca. 200 kg di CO<sub>2</sub> contro i 900 kg di CO<sub>2</sub> prodotti riciclando l'acciaio.

*Each ton of aluminium produced from scrap metal generates around 200 kg. of CO<sub>2</sub> versus 900 kg. of CO<sub>2</sub> produced recycling steel.*

A parità di ingombro un radiatore realizzato in alluminio rende mediamente il 17% in più rispetto ad uno in acciaio.

*Taking into consideration the same size, a radiator made of aluminium is 17% more efficient than one made of steel.*

A parità di resa termica un radiatore in alluminio pesa mediamente la metà di uno in acciaio.

*With the same thermal efficiency, the weight of a radiator made of aluminium is half the weight of one made of steel.*

La flessibilità del radiatore realizzato in alluminio nel reagire alle diverse richieste termiche è doppia rispetto ad un radiatore realizzato in acciaio.

*The flexibility in terms of reaction to different thermal demands of a radiator made of aluminium is double when compared to a radiator made of steel.*

#### MINORE QUANTITÀ D'ACQUA

A parità di resa termica i radiatori in alluminio contengono una quantità d'acqua decisamente inferiore rispetto ai radiatori in acciaio o in ghisa, questo si traduce in tempi inferiori di riscaldamento e minore utilizzo della caldaia, con conseguente riduzione dei costi energetici.

#### LESS QUANTITY OF WATER

*On equal thermal efficiency the radiators made of aluminium contain a decisively lower quantity of water compared to radiators made of steel or cast iron. This means that the time necessary to heat is less with less use of a boiler with a consequent reduction of energy costs.*



ferro / ghisa  
iron / cast iron

alluminio  
aluminum

BIT

#### ANCHE IL 20% DEI COSTI IN MENO

Rispetto ai pannelli radianti, studi certificati hanno dimostrato che a parità di condizioni di funzionamento, gli impianti con pannelli radianti hanno un consumo energetico superiore ad un impianto realizzato con radiatori in alluminio. Il risparmio con i radiatori in alluminio arriva addirittura a un 20% quando la temperatura dei locali viene modificata durante la giornata.

#### 20% COSTS REDUCTION

*Certified studies have demonstrated that on equal conditions of functioning, the systems with radiant panels have higher energy consumption if compared to aluminium radiators. With aluminium radiators energy savings reach up the 20% even when the temperature is modified during the whole day.*

## I 14 PUNTI DI FORZA DELL'ALLUMINIO IN RAFFRONTO ALL'ACCIAIO

## THE 14 ADVANTAGES OF ALUMINIUM IF COMPARED TO STEEL

- |  |  |
|--|--|
| <b>1</b> BIT e BITLIGHT sono realizzati al 100% in alluminio riciclato.  | <b>1</b> BIT and BITLIGHT are made of 100% recycled aluminum.  |
| <b>2</b> BIT e BITLIGHT sono riciclabili all'infinito (questo li rende ecologici in quanto produrre una tonnellata di alluminio riciclato genera 0,1 tonnellate di CO <sub>2</sub> contro 1,9 tonnellate di CO <sub>2</sub> dell'acciaio riciclato). | <b>2</b> BIT and BITLIGHT can endlessly be recycled (making them environmentally friendly since a ton of recycled aluminum generates 0,1 ton of CO <sub>2</sub> versus 1,9 tons of CO <sub>2</sub> produced by steel). |
| <b>3</b> BIT e BITLIGHT pesano circa 1/3 rispetto ai radiatori in acciaio (a parità di dimensioni).  | <b>3</b> BIT and BITLIGHT weigh 1/3 of steel radiators (of the same size).   |
| <b>4</b> BIT e BITLIGHT contengono 1 litro d'acqua per ogni kW termico generato, mentre mediamente un radiatore in acciaio necessita di 15 litri d'acqua per ogni kW termico generato (riducendo la bolletta energetica).                            | <b>4</b> BIT and BITLIGHT contain 1 liter of water for every kW of heat generated, while on average a steel radiator requires 15 liters of water for every kW of heat generated (hence reduces energy consumption).    |
| <b>5</b> BIT e BITLIGHT hanno la conducibilità termica 10 volte migliore dell'acciaio (22 contro 204 W/m°C).   | <b>5</b> BIT and BITLIGHT have 10 times better thermal conductivity than steel (22 to 204 W / m° C).   |
| <b>6</b> BIT e BITLIGHT a parità di forma e dimensione rendono mediamente il 17% in più rispetto ad uno in acciaio.  | <b>6</b> BIT and BITLIGHT produce on average 17% more heat when compared to steel in equal sizes.  |
| <b>7</b> BIT e' realizzato in un singolo pezzo a differenza del radiatore in acciaio realizzato saldando piu' elementi.  | <b>7</b> BIT is made of a single block instead of being composed of various elements welded together like steel radiators.   |
| <b>8</b> BIT non avendo saldature non ha residui e scorie tipiche dell'acciaio che sono causa di ostruzioni nelle caldaie e nel circuito idraulico.  | <b>8</b> BIT does not have welded parts and therefore it does not produce residuals typical of steel. Residuals are the cause of obstructions of boilers and plumbing systems.   |
| <b>9</b> BIT e BITLIGHT, a differenza dei radiatori in acciaio, non arrugginiscono.  | <b>9</b> BIT and BITLIGHT, unlike steel radiators, do not rust.  |
| <b>10</b> BIT e BITLIGHT hanno una vita molto piu' lunga grazie allo spessore del passaggio dell'acqua di 6 mm contro lo spessore dell'acciaio di circa 1 mm.  | <b>10</b> BIT and BITLIGHT have a longer life thanks to the 6 mm water passage versus the 1 mm water passage of steel radiators.   |
| <b>11</b> BIT con il suo spessore importante permette l'utilizzo in circuiti ad elevata pressione anche fino a 16 atmosfere contro le 6 del normale radiatore in acciaio.  | <b>11</b> BIT, thanks to its thickness, allows the use of high pressure circuits up to 16 Atmospheres against 6 of standard steel radiators.   |
| <b>12</b> BIT e BITLIGHT hanno tempi ridotti di riscaldamento a Messa a Regime (da 5°C a 21°C):<br>- alluminio 48 min<br>- acciaio o ghisa 78 min  | <b>12</b> BIT and BITLIGHT have reduced heating times (from 5° C to 21° C):<br>- Aluminium 48 min<br>- Steel or cast iron 78 min   |
| <b>13</b> BIT si adatta ad impianti idraulici monotubo o bitubo.   | <b>13</b> BIT can be used both with single and double pipe water systems.  |
| <b>14</b> BITLIGHT versione elettrica ha:<br>- parte elettrica a secco<br>- sonda termica locale<br>- elettronica integrata<br>- gestione con file pilote per impianti predisposti.  | <b>14</b> BITLIGHT in the electric version has:<br>- Electrical part is Dry<br>- Local thermal probe<br>- Integrated electronics<br>- Management with "file pilote" with a predisposed system.                         |

BITLIGHT / BIT



Verniciabile esternamente in tutti i colori del nostro campionario  
*Can be externally lacquered in all colors of our collection*



TERMOARREDI  
DESIGNER RADIATOR





TERMOARREDI  
DESIGNER RADIATOR







TERMOARREDI  
DESIGNER RADIATOR





H	P	L	art.
120	7	45	BITL120E
150	7	45	BITL150E
180	7	45	BITL180E

Termoarredo in alluminio versione elettrica, completo di cronotermostato (1), Brown o colorato gofrato come da nostra cartella colori laccati.

*Aluminium designer radiator, electric version, complete with programmable thermostat (1), Brown or lacquered embossed as per our colour chart.*

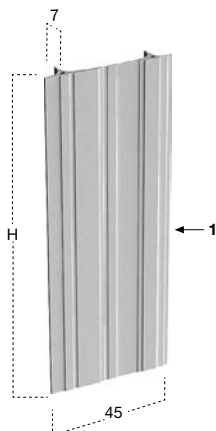

H	P	L	art.
120	7	45	BITL120A
150	7	45	BITL150A
180	7	45	BITL180A

Termoarredo in alluminio versione ad acqua, Brown o colorato gofrato come da nostra cartella colori laccati.

*Aluminium designer radiator, water version, Brown or lacquered embossed as per our colour chart.*

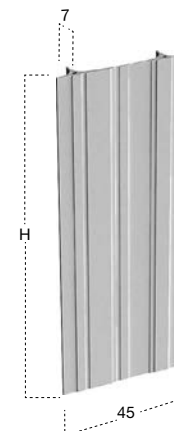

art.  
BIT\_TT

Testa termostatica con sensore a liquido per art. BIT\_TERM0 e art. BIT\_REMO per termoarredo versione ad acqua in finitura cromo lucido o acciaio satinato.

*Thermostatic head with liquid sensor for art. BIT\_TERM0 and art. BIT\_REMO for water version radiators in polished chrome finish or satin steel finish.*



art.  
BIT\_REMO

Gruppo valvola remoto termostattizzabile ad incasso con attacchi 1/2" F per impianto bitubo, per termoarredo versione ad acqua, in finitura cromo lucido.

*Remote thermostatic radiator valve to be encased with 1/2" F connectors for two-pipe system, for water version radiators in polished chrome finish.*



art.  
BIT\_TERM0

Gruppo valvola termostattizzabile e detentore 50 mm a squadra, con kit raccordi intercambiabili per tubo in rame ø 10-12-14 e multistrato ø 10/14 - 12/16, in finitura cromo lucido o acciaio satinato.

*Thermostatic radiator valve and angle lockshield 50 mm with interchangeable fittings kit for copper tube ø 10-12-14 and plywood ø 10/14 - 12/16, in polished chrome finish or satin steel finish.*

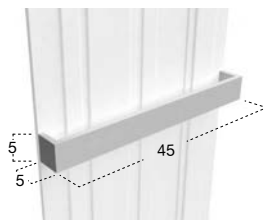

H	P	L	art.
5	5	45	BITBARRA

Porta salviette per termoarredo in acciaio inox satinato AISI 304, Brown o colorato gofrato come da nostra cartella colori laccati.

*Towel holder for radiator in satin stainless steel AISI 304, Brown or lacquered embossed as per our colour chart.*

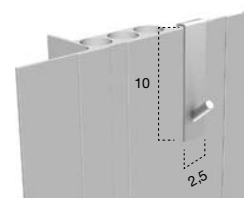

H	L	art.
10	2,5	GANCIOLIGHT

Appendi abiti per termoarredo in acciaio inox satinato AISI 304, Brown o colorato gofrato come da nostra cartella colori laccati.

*Clothes hook for radiators in satin stainless steel AISI 304, Brown or lacquered embossed as per our colour chart.*



## BIT

I termoarredi nella versione bianco opaco (RAL 9010) possono essere personalizzati con l'utilizzo di vernici quali:

- smalto al solvente satinato, antigraffio e anticorrosivo.
- smalto ad acqua antigraffio.

I termoarredi nella versione colorato gofrato sono verniciati come da nostra cartella colori mobili.

*Designer radiators in matt white finishing (RAL 9010) can be customized using paintings like:*

- *satin solvent-based lacquer, anti-scratch and anticorrosive.*
- *anti-scratch water-based lacquer.*

*Designer radiators in embossed lacquered version can be painted as per our furniture colour chart.*

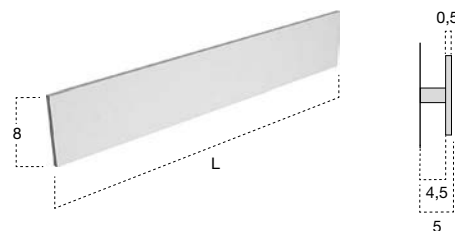

H	P	L	art.
8	5	54	RETTA454
		72	RETTA472
		90	RETTA490
		108	RETTA4108

Porta salviette in alluminio verniciato bianco, nero opaco o colorato gofrato come da nostra cartella colori laccati.

*Towel holder in aluminium lacquered matt white, black or embossed as per our colour chart.*

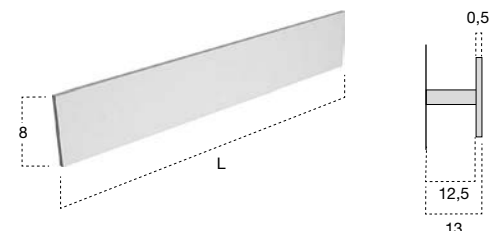

H	P	L	art.
8	13	54	RETTA1254
		72	RETTA1272
		90	RETTA1290
		108	RETTA12108

Porta salviette in alluminio verniciato bianco, nero opaco o colorato gofrato come da nostra cartella colori laccati.

*Towel holder in aluminium lacquered matt white, black or embossed as per our colour chart.*

Misure standard.

Standard measurements



H	P	L	art.
60	8,2	45	BIT60A
90	8,2	45	BIT90A
120	8,2	45	BIT120A
150	8,2	45	BIT150A
180	8,2	45	BIT180A

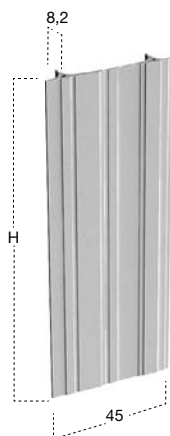

A misura.

Made to measure



H	P	L	art.
45	8,2	45	BIT45E
60	8,2	45	BIT60E
90	8,2	45	BIT90E
120	8,2	45	BIT120E
150	8,2	45	BIT150E
180	8,2	45	BIT180E

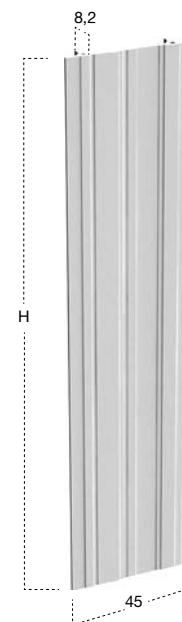

H	P	L	art.
60	8,2	45	BIT60AE
90	8,2	45	BIT90AE
120	8,2	45	BIT120AE
150	8,2	45	BIT150AE
180	8,2	45	BIT180AE

Termoarredo in alluminio versione ad acqua, elettrica o mista acqua/elettrica, bianco opaco RAL 9010 o colorato gofrato come da nostra cartella colori laccati.

Aluminium designer radiator, water, electric, or combined water/electric version, matt white RAL 9010 or lacquered embossed as per our colour chart.



H	P	L	art.
61/149	8,2	45	BIT1A
151/200	8,2	45	BIT2A
201/300	8,2	45	BIT3A

Termoarredo in alluminio versione ad acqua con altezza H a misura, bianco opaco RAL 9010 o colorato gofrato come da nostra cartella colori laccati.

Aluminium designer radiator, water version, with custom height H, matt white RAL 9010 or lacquered embossed as per our colour chart.



art.  
BIT\_REMO

Gruppo valvola remoto termostattizzabile ad incasso con attacchi 1/2" F per impianto bitubo, per termoarredo versione ad acqua, in finitura cromo lucido.

Remote thermostatic radiator valve to be encased with 1/2" F connectors for two-pipe system, for water version radiators in polished chrome finish.



art.  
BIT\_TT

Testa termostatica con sensore a liquido per art. BIT\_TERMO e art. BIT\_REMO per termoarredo versione ad acqua in finitura cromo lucido o acciaio satinato.

Thermostatic head with liquid sensor for art. BIT\_TERMO and art. BIT\_REMO for water version radiators in polished chrome finish or satin steel finish.



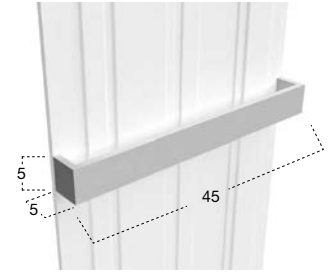

H	P	L	art.
5	5	45	BITBARRA

Porta salviette per termoarredo in acciaio inox satinato AISI 304, bianco opaco RAL 9010 o colorato gofrato come da nostra cartella colori laccati.

*Towel holder for radiator in satin stainless steel AISI 304, matt white RAL 9010 or lacquered embossed as per our colour chart.*

Possibile posizionamento per porta salviette Art. BITBARRA.

*Possible position of towel holder Art. BITBARRA.*

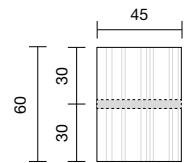
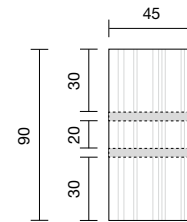
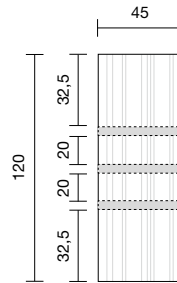
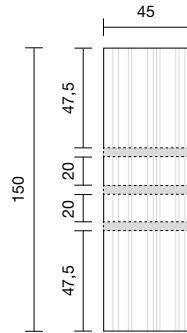
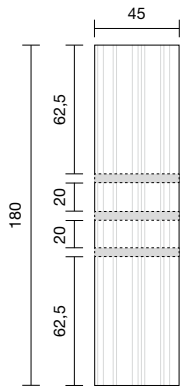

TERMOARREDI  
DESIGNER RADIATOR

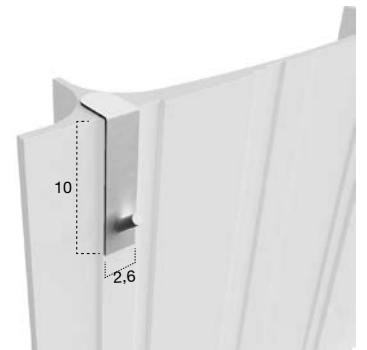

H	L	art.
10	2,6	BITGANCIO

Appendi abiti per termoarredo in acciaio inox satinato AISI 304, bianco opaco RAL 9010 o colorato gofrato come da nostra cartella colori laccati.

*Clothes hook for radiators in satin stainless steel AISI 304, matt white RAL 9010 or lacquered embossed as per our colour chart.*







TERMOARREDI  
DESIGNER RADIATOR



H	P	L	art.
23	6,4	90	BITL190E
23	6,4	120	BITL1120E

Termoarredo orizzontale in alluminio versione elettrica, completo di portasalviette e cronotermostato (1), Brown o colorato gofrato come da nostra cartella colori laccati.

*Horizontal aluminium designer radiator, electric version, complete with towel holder and programmable thermostat (1), Brown or lacquered embossed as per our colour chart.*

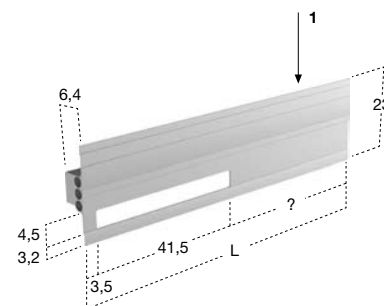

# STECCA

\_2019

design  
Nevio  
Tellatin

Stecca è uno scaldasalviette in alluminio dalla forma rettilinea che diventa un pratico porta salviette, ha il fronte solcato da leggeri segni paralleli che ne descrivono lo sviluppo longitudinale. Tre le lunghezze disponibili, 60/90/120 cm, per adattarsi al meglio alle richieste di spazio.

Il funzionamento elettrico viene regolato da un interruttore di accensione touch laterale, che può essere collocato indifferentemente a destra o a sinistra, a seconda delle esigenze dell'utente.

Anche la quota a cui viene posizionato Stecca sulla parete può essere scelta in base alle esigenze del cliente e alla composizione dell'area lavabo.

La massima personalizzazione riguarda ovviamente anche gli aspetti cromatici. Lo scaldasalviette è disponibile nella versione base in colore Bianco RAL 9010, che su richiesta può essere in smalto al solvente satinato, antigraffio e anticorrosivo, oppure in smalto ad acqua antigraffio; mentre nella versione laccato goffrato è disponibile in tutta la cartella colori di antoniolupi.

*Stecca is an aluminum towel warmer with straight lines which becomes a functional towel holder as well. The surface is characterised by light parallel lines creating a longitudinal pattern. Available in three lengths, 60/90/120 cm, it is easily adaptable to different spaces.*

*This electric towel rail is switched on and off through a lateral touch control which can be placed on the right or the left side, according to the customer's needs.*

*Also the height to install Stecca on the wall is variable and can be chosen by the client depending also on the sink position. The highest customization concerns the colour: the towel rail is available in the basic version, White colour RAL 9010, but upon request can be in satin solvent-based varnish to grant an anti-scratch and anticorrosive action, or in anti-scratch water-based varnish; the lacquered version is embossed and available in all colours of antoniolupi chart.*



TERMOARREDI  
DESIGNER RADIATOR





TERMOARREDI  
DESIGNER RADIATOR



H	P	L	art.
12	7	60	STECCA60
		90	STECCA90
		120	STECCA120

Scaldasalviette orizzontale in alluminio versione elettrica, completo di interruttore laterale di accensione touch (1). Bianco opaco RAL 9010 o colorato gofrato come da nostra cartella colori laccati.

Horizontal aluminum towel rail, electric version, with side switch touch (1). Matt white RAL 9010 or lacquered embossed as per our colour chart.

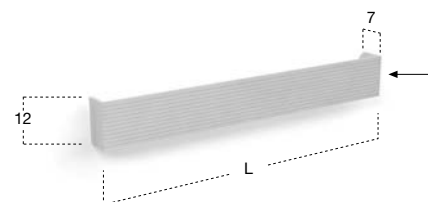

# CRISTALMOOD

\_2018

design  
AL Studio

Resistente come la pietra, trasparente come il cristallo.  
*Resistant as stone, clear as crystal.*



# VASCHE *TUBS*



Il Cristalmood è una resina di nostra creazione che viene colata manualmente negli stampi. Gli oggetti una volta estratti, devono essere rifiniti manualmente mediante carteggiatura per togliere tutte le imperfezioni sia all'interno che all'esterno. Come se fosse di pietra, ogni prodotto risulta così unico, le leggere differenze di colore, di dimensione, o le piccole bolle d'aria che possono formarsi, danno anima e autenticità ad ogni oggetto.

*Cristalmood is a resin of our own creation that is manually poured into molds. Once extracted, the objects must be finished manually by sanding them to remove all imperfections both inside and out. As if it were made of stone, each product is unique, the slight differences in color, size, or small air bubbles that can form, give soul and authenticity to each object.*





# REFLEX

\_2018

design  
AL Studio

Leggerezza e solidità, rigore ed espressività, materia e colore, la poetica degli opposti. Un nuovo materiale frutto della ricerca antoniolupi, si aggiunge al Flumood e al Quarzomood. Denominato Cristalmood per le sue caratteristiche di trasparenza e lucentezza, è una resina di nuova generazione, colorabile, resistente, versatile. Cristalmood è una resina colorata, trasparente, a finitura lucida, composta da resina poliestere di alta qualità e pigmenti coloranti; ha superato i test anticorrosione (nebbia salina) e può essere pulita con tutti i detergenti più comuni, resistendo anche ad alcool denaturato, acetone, olii, benzene o gasolio. Reflex è una vasca dal disegno minimale, con un bordo importante: una vasca che ha l'impatto della pietra, la trasparenza del cristallo e invece, grazie alla sua composizione, un peso inferiore di circa il 30% rispetto ai solid surface come il nostro Flumood.

*Lightness and solidity, rigor and expressiveness, material and color, poetry of opposites. A new material, result of the antoniolupi research is added to Flumood and Quarzomood. It is named Cristalmood due to its transparency and sheen, a new generation colored resin, resistant and versatile. Cristalmood is a colored resin, transparent with a glossy finish, composed of high quality polyester resin and coloring pigments; has passed the anti-corrosion tests (salt spray) and can be cleaned with all the most common detergents, also resisting to rubbing alcohol, acetone, oils, gasoline or diesel fuel. Reflex has a minimal design and an important border: a bathtub which has the impact of stone and transparency of crystal, instead thanks to its composition, has an inferior weight of almost 30% with respect to solid surfaces such as our Flumood.*





VASCHE  
TUBS

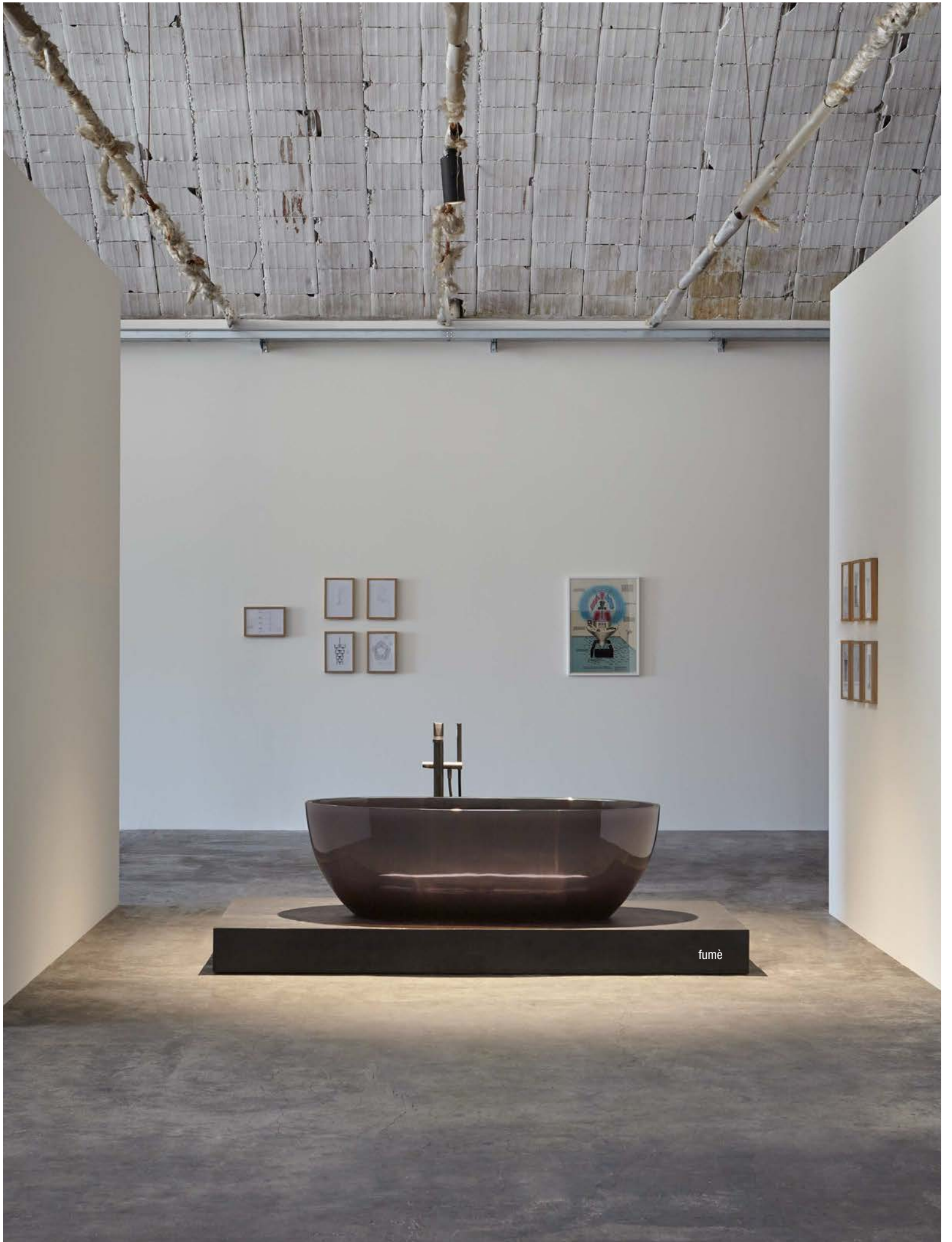



ginger

REFLEX



nebbia



ocra



petrolio



bottiglia



lime



cobalto



sangria



ambra







fumè

VASCHE  
TUBS

H	P	L	art.
53	86	167	REFLEX

Vasca da bagno ovale in Cristalmood, disponibile nei colori del nostro campionario, completa di piletta con sistema di scarico a pressione klik clak, sifone e tubo flessibile.

Peso vasca: 121 kg  
Capacità: 350 l

*Oval Cristalmood bathtub available in various colors complete with drain and pressure plug, siphon and flexible hose.*

*Weight: 121 kg  
Capacity: 350 l*

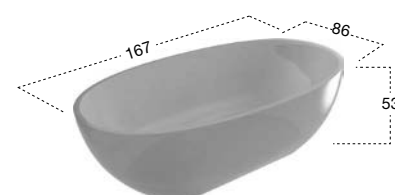





Verniciabile esternamente in tutti i colori del nostro campionario  
*Can be externally lacquered in all colors of our collection*

VASCHE  
TUBS

H	P	L	art.
53	86	167	REFLEXMOOD

Vasca da bagno ovale in Flumood, completa di piletta con sistema di scarico a pressione clik clak, sifone e tubo flessibile.

Peso vasca: 110 kg  
 Capacità: 350 l

*Oval Flumood bathtub, complete with drain and pressure plug, siphon and flexible hose.*

*Weight: 110 kg  
 Capacity: 350 l*

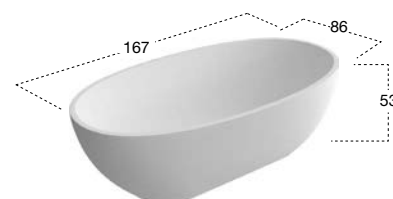

# DUNE

\_2009

design  
Mario  
Ferrarini

Organica nella forma, naturale nello sviluppo delle linee, morbida e accogliente nel suo segno distintivo. Un'oasi di benessere originata da una forma circolare e definita da un bordo sinusoidale.

La metafora della natura guida il progetto Dune, declinato in una vasca dall'immagine morbida che custodisce un bene prezioso in un perimetro mosso e articolato. Accogliente e priva di discontinuità, non presenta un fronte privilegiato e può assumere configurazioni diverse sia nella versione free standing che in quella a semi incasso. Le continue variazioni di altezza del bordo è il tratto distintivo di una proposta di carattere ma allo stesso tempo versatile e flessibile.

*Organic in shape natural development of lines, soft and cozy in its hallmark. An oasis of well-being originated from a circular shape and defined by a sinusoidal edge. Welcoming and free of discontinuities, it doesn't have a privileged side and can assume different configurations both in the freestanding version as the semi-recessed one. The continuous variation in height of the edge is the hallmark of a proposal of character but at the same time flexible and versatile.*



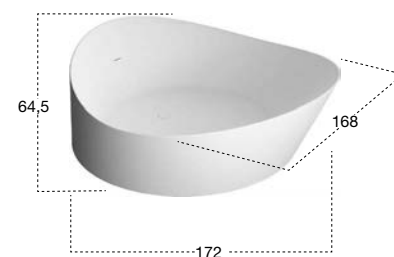

H	P	L	art.
64,5	168	172	DUNE1

Vasca da bagno tonda in Cristalplant, completa di piletta con sistema di scarico a pressione clik-clak, sifone e tubo flessibile.

Peso vasca: 191 kg.

Capacità: 430 L.

*Round Cristalplant bathtub complete with drain pipe fitting and pressure plug, siphon and flexible hose.*

*Weight: 191 kg.*

*Capacity: 430 L.*



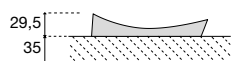

H	P	L	art.
64,5	168	172	DUNE2

Vasca da bagno tonda a semincasso in Cristalplant, completa di piletta con sistema di scarico a pressione klik-clak, sifone e tubo flessibile.

Peso vasca: 142 kg.

Capacità: 430 L.

*Semi-encased round Cristalplant bathtub complete with drain pipe fitting and pressure plug, siphon and flexible hose.*

*Weight: 142 kg.*

*Capacity: 430 L.*

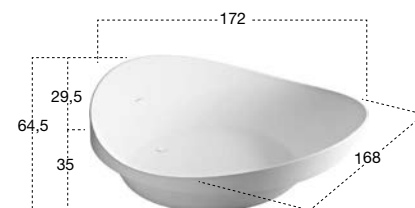

# MASTELLO

\_2019

design  
Mario  
Ferrarini

Un elemento conosciuto da tutti, un nome che rimanda immediatamente a tempi lontani, alla memoria del rito del lavarsi in un'epoca nella quale l'acqua corrente era davvero un lusso. Un oggetto che diventava "luogo", perché proprio il mastello, collocato al centro della stanza diventava il fulcro della scena, attorno al quale giocare, raccontare storie, condividere emozioni.

antonio lupi e Mario Ferrarini ne reinterpretano il significato con Mastello, la vasca-tinozza in Flumood dall'immagine elegante, fatta di linee fluide, forme morbide e candide superfici che si sviluppano senza soluzione di continuità. Una forma pura, organica e accogliente, nella quale anche i dettagli contribuiscono al salto temporale. Dal salto di quota interno che facilita la posizione seduta al gradino esterno in legno che permette a tutti di accedere facilmente all'interno della vasca.

Mastello è una vasca ergonomica, grazie alla comodità della seduta integrata e al bordo che si innalza dolcemente verso una delle estremità e funge da poggiatesta, ma è anche un elemento funzionale e capiente. Con i suoi 135 cm può essere installata infatti in ambienti bagno dalle dimensioni contenute, ma può ospitare comodamente al suo interno persone alte più di 195 cm. Una micro oasi di relax per tutti, un benessere garantito per il corpo ma anche per la mente, un "rinfrescare" una memoria fatta di gesti semplici che davano valore alle cose.





*A micro oasis of relaxation for everyone, a well-being guaranteed for body and mind, a refreshing memory made of simple gestures that gave value to true things.*

*“Mastello” in Italian is an old wooden tub used in the past for bathing. The name of the new product immediately recalls the ritual of bathing in an era in which running water was truly a luxury. An object that became a “place “ because the Mastello (tub), placed in the middle of the room, became the centre of the scene around which to play, tell stories, and share emotions.*

*antoniolupi and Mario Ferrarini reinterpret its meaning with a new elegant bathtub called Mastello. The new bathtub in Flumood, is made of fluid lines, soft shapes and candid surfaces that develop without interruptions.*

*A bathtub with pure shapes, natural and welcoming, that revisits the essence of traditional old Mastello tub. The internal step facilitates the sitting position as well as the external wooden step allows everyone to easily access the bathtub.*

*Mastello is an ergonomic bathtub yet at the same time functional, thanks to the comfortable integrated seat and the edge that rises gently towards one of the ends and acts as a headrest. It is a capacious bathtub, with its 135 cm. it can in fact be installed also in smaller bathrooms, but it can comfortably accommodate people over 195 cm. tall.*



MASTELLO





Anche una persona alta oltre 190 cm può comodamente fare il bagno.  
*Even a person taller than 190 cm can comfortably take a bath.*





Verniciabile esternamente in tutti i colori del nostro campionario  
 Can be externally lacquered in all colors of our collection

H	P	L	art.
15	20	70	PEDANA

Accessorio in massello di Rovere naturale per vasca.

*Solid oak accessory for bathtub.*

H	P	L	art.
87	75	135	MASTELLO

Vasca da bagno ovale in Flumood completa di piletta con sistema di scarico a pressione clik clak, sifone e tubo flessibile.

Peso vasca: 120 kg

Capacità: 275 l

*Oval Flumood bathtub complete with drain and pressure plug, siphon and flexible hose.*

*Weight: 120 kg*

*Capacity: 275 l*

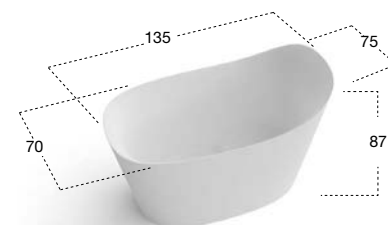
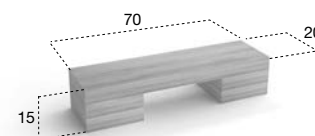

# ECLIPSE

\_2017

design  
Marco  
Di Paolo

Elegante e funzionale, dalla forte presenza scenica ma allo stesso tempo capace di inserirsi in contesti diversi: Eclipse è una vasca avvolgente dalla forma a uovo che accoglie e protegge ergonomicamente il corpo. La continuità delle linee e delle superfici resa possibile dall'utilizzo del Cristalplant descrive un volume organico e capiente che può occupare con personalità il centro della stanza ma anche accostarsi a una parete secondo una disposizione personalizzata, non avendo in sé alcuna gerarchia dei fronti come nell'essenza del "tutto tondo".

Ad accrescere la funzionalità della vasca è stata sviluppata una piccola mensola portaoggetti, integrata nel volume con armonia e misura. Una traccia che ingentilisce il bordo e diventa un segno distintivo di raffinatezza, un dettaglio prezioso che sottolinea la forma senza rimanere fine a sé stesso ma al contrario diventa pratica base da appoggio per ospitare tutti gli accessori in un relax davvero completo.

*Elegant and functional, with strong stage presence but at the same time able to fit in different contexts: Eclipse is an enveloping egg-shaped tub that welcomes and ergonomically protects the body.*

*The continuity of the lines and surfaces made possible by the use of Cristalplant describes a large volume that can occupy the center of the room with personality but also be placed in a personalized arrangement. To increase the functionality of the bathtub, a small storage shelf has been developed and integrated into its volume with harmony and measure.*

*A trace that softens the edge and becomes a distinctive sign of refinement, a precious detail that emphasizes the shape and becomes a practical shelf to accommodate all the accessories for a truly complete relaxation.*





VASCHE  
TUBS

ECLIPSE







VASCHE  
TUBS





Verniciabile esternamente in tutti i colori del nostro campionario  
*Can be externally lacquered in all colors of our collection*

VASCHE  
TUBS

H	P	L	art.
53	95,5	185	ECLIPSE

Vasca da bagno ovale in Cristalplant, completa di piletta con sistema di scarico a pressione klik clak, sifone e tubo flessibile.

Peso vasca: 141 kg.

Capacità: 350 L.

*Oval Cristalplant bathtub complete with drain and pressure plug, siphon and flexible hose.*

*Weight: 141 kg.*

*Capacity: 350 L.*

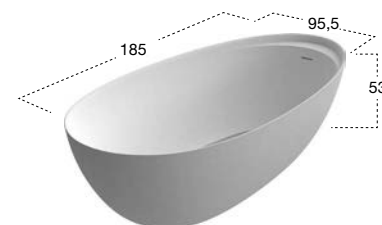

# ECLIPSE SMALL

\_2018

design  
Marco  
Di Paolo

Realizzata in Cristalplant, elegante e funzionale come la sorella più grande, anche Eclipse Small è una vasca avvolgente dalla forma a uovo che accoglie e protegge ergonomicamente il corpo. Collocabile facilmente anche in ambienti più piccoli, con la sua lunghezza di 160 cm, non fa rimpiangere vasche che occupano molto più spazio. Ad accrescerne la funzionalità, Eclipse Small ha una piccola mensola portaoggetti integrata che ne impreziosisce il bordo e che può ospitare quanto serve per avere tutto a portata di mano.

*Made of Cristalplant, elegant and functional like its bigger sister, Eclipse Small is also an enveloping egg-shaped bathtub that ergonomically welcomes and protects the body.*

*Can be easily placed even in smaller spaces, with a length of 160 cm, it doesn't make you regret larger bathtubs.*

*To increase its functionality, Eclipse Small has an integrated shelf that embellishes the edge and that can accommodate everything you need at your fingertips.*





Anche una persona alta oltre 190 cm può comodamente fare il bagno.  
*Even a person taller than 190 cm can comfortably take a bath.*



VASCHE  
TUBS





Verniciabile esternamente in tutti i colori del nostro campionario  
*Can be externally lacquered in all colors of our collection*

VASCHE  
 TUBS

H	P	L	art.
53	75	160	ECLIPSES

Vasca da bagno ovale in Cristalplant, completa di piletta con sistema di scarico a pressione klik clak, sifone e tubo flessibile.

Peso vasca: 80 kg  
 Capacità: 240 l

*Oval Cristalplant bathtub, complete with drain and pressure plug, siphon and flexible hose.*

*Weight: 80 kg  
 Capacity: 240 l*

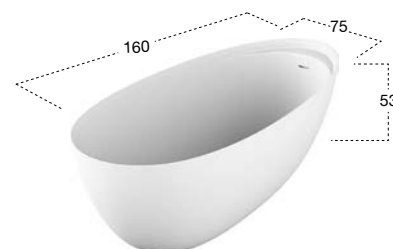

# DAFNE

\_2016

design

Daniel Debiasi

Federico Sandri

Una forma naturale, sobria ma allo stesso tempo organica, un progetto che attraverso piccole variazioni sul tema esprime un perfetto connubio tra estetica e funzionalità. Una vasca elegante, dall'immagine leggera, rassicurante e dalla forma compatta, che gioca su un delicato equilibrio dimensionale per dar vita a un elemento confortevole e accattivante: Dafne trova nel bordo che si alza leggermente in corrispondenza di uno dei lati uno dei tratti distintivi del progetto, non solo dal punto di vista formale ma anche un sotto l'aspetto funzionale perchè aumenta il comfort complessivo. Il bordo sollevato accoglie infatti comodamente le spalle, mentre le linee curve del bacino che si sviluppano senza soluzione di continuità invitano ad immergersi per piacevoli momenti di relax.

*Natural form, sober yet organic, a project that through small variations expresses a perfect combination of aesthetics and functionality. An elegant bathtub seemingly light and compact in size that plays upon a delicate dimensional balance to give life to a comfortable and attractive element: one side slightly raised is the hallmark of the project increasing the overall comfort. This raised part accommodates the shoulders while the curved lines of the bottom invite you to immerse in wonderful moments of relaxation.*







VASCHE  
TUBS





H	P	L	art.
56	71,6	170	DAFNE

Vasca da bagno ovale in Cristalplant, completa di piletta con sistema di scarico a pressione klik clak, sifone e tubo flessibile.

Peso vasca: 110 kg.

Capacità: 275 L.

*Oval Cristalplant bathtub complete with drain and pressure plug, siphon and flexible hose.*

*Weight: 110 kg.*

*Capacity: 275 L.*

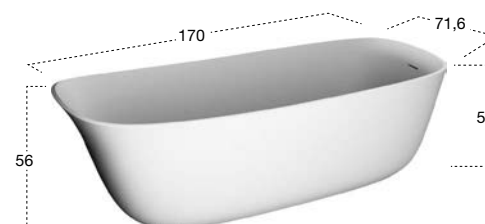

# BAIA

\_2004

design  
Carlo  
Colombo

Essenziale ma con una forte personalità, pura nelle forme ma organica nel suo sviluppo complessivo, moderna pur nell'impronta classica, continua nell'assoluta assenza di spigoli. Un capolavoro di antoniolupi, un progetto che ha segnato un'inizio, anzi l'inizio del modo nuovo di concepire l'oggetto vasca. Prodotto per la prima volta nel 2004 Baia è ancor oggi una delle assolute protagoniste della gamma e uno dei modelli più venduti.

Design pulito ed elegante, armonia e minimalismo accentuati dall'impiego del Cristaplast o arricchiti da sfumature uniche e tracce irripetibili qualora venga realizzata in pietra. Gli spessori sottilissimi garantiti dall'impiego del solid surface, aumentano considerevolmente quando viene impiegato il materiale naturale. L'eterea presenza e il candore di Baia, nella versione "artificiale" lasciano spazio alla solidità e al lusso concreto della versione in pietra. La base di dimensioni ridotte garantisce leggerezza alla composizione e interrompe la continuità del volume per sottolineare l'importanza della matrice generativa.



art. BAiA  
L 185 \_ P 90 \_ H 50

*Basic but with a strong personality pure in form but organic in its overall development. Modern yet classic with an absolute absence of sharp edges. A masterpiece by antoniolupi, a project that has marked a beginning, indeed that of a new way of conceiving the bathtub. Introduced in 2004, Baia, is still today one of the absolute protagonists of the range and one of the best selling models. Clean and elegant design harmony and minimalism marked by the use of Cristalplant or enriched by unique shades and unrepeatability trace when made of stone. Thin borders guaranteed by the use of solid surface significantly increase with natural stone. The ethereal presence and the candor of Baia in the artificial version give way to solid and concrete luxury of stone. The smaller version guarantees lightness to the composition and breaks the continuity of the volume.*

# BAIA SMALL

\_2014

design  
Carlo  
Colombo



VASCHE  
TUBS





Verniciabile esternamente in tutti i colori del nostro campionario  
*Can be externally lacquered in all colors of our collection*

VASCHE  
 TUBS



H	P	L	art.
50	90	185	BAIA

Vasca da bagno ovale in Cristalplant, completa di piletta con sistema di scarico a pressione clik-clak, sifone e tubo flessibile.

Peso vasca: 90 kg.

Capacità: 400 L.

*Oval Cristalplant bathtub complete with drain pipe fitting and pressure plug, siphon and flexible hose.*

*Weight: 90 kg.*

*Capacity: 400 L.*







Verniciabile esternamente in tutti i colori del nostro campionario  
*Can be externally lacquered in all colors of our collection*

VASCHE  
TUBS



H	P	L	art.
53	70	170	BAIAS

Vasca da bagno ovale in Cristalplant, completa di piletta con sistema di scarico a pressione clik-clak, sifone e tubo flessibile.

Peso vasca: 78 kg.

Capacità: 247 L.

*Oval Cristalplant bathtub complete with drain pipe fitting and pressure plug, siphon and flexible hose.*

*Weight: 78 kg.*

*Capacity: 247 L.*

# AGO

\_2015

design  
Mario  
Ferrarini

Un'immagine contemporanea nata dall'equilibrata fusione di geometrie, linee curve e rette; un bordo sottile che identifica un perimetro e definisce un limite; una forma compiuta e avvolgente; vasca in Cristalplant dalla geometria ovale, perfetta sintesi tra parti curve ad ampio raggio e lati inclinati che dalla base salgono ad incontrare la parte curva.

*A contemporary image created by the balanced fusion of geometrical shapes, curves and straight lines; a thin edge that identifies the perimeter and defines a limit; a complete and enveloping shape. A bathtub in Cristalplant with an oval shape, perfect synthesis between curves and sloping sides.*





VASCHE  
TUBS





Verniciabile esternamente in tutti i colori del nostro campionario  
*Can be externally lacquered in all colors of our collection*

VASCHE  
TUBS

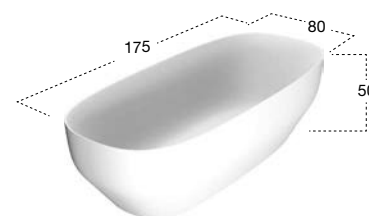

H	P	L	art.
50	80	175	AG04

Vasca da bagno ovale in Cristalplant, completa di piletta con sistema di scarico a pressione clik-clak, sifone e tubo flessibile.

Peso vasca: 131 kg.

Capacità: 345 L.

*Oval Cristalplant bathtub complete with drain and pressure plug, siphon and flexible hose.*

*Weight: 131 kg.*

*Capacity: 345 L.*

# FUNNY WEST

\_2009

design  
Paolo Cappello  
Federico Sandri



Un'onda appena annunciata, un bordo che cresce in altezza e si trasforma da elemento contenitivo in schienale senza soluzione di continuità. Funny West trasmette un'immagine un pò scanzonata, uno stile informale ma elegante allo stesso tempo, un profilo a metà tra un fenomeno naturale e la scocca di un bolide che percorre le highway correndo verso la West Coast. Una piccola ma grande vasca, lunga solo 151 cm ma in grado di ospitare comodamente due persone grazie a un progetto attento alle proporzioni e all'ergonomia, caratteri imprescindibili di tutti i prodotti antoniolupi.

*A wave just reported, an edge that increases in height and is transformed from a restraining element in the backrest without solution of continuity. Funny West transmits an image a little carefree, casual yet elegant somewhere between a natural phenomenon and the body of a fireball that travels the highway running to the West Coast.*



VASCHE  
TUBS

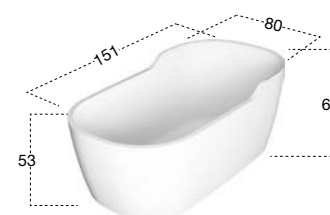

H	P	L	art.
60	80	151	FUNNY WEST

Vasca da bagno ovale in Cristalplant, completa di piletta con sistema di scarico a pressione clik-clak sifone e tubo flessibile.

Peso vasca: 95 kg.

Capacità: 292 L.

*Oval Cristalplant bathtub complete with drain and pressure plug, siphon and flexible hose.*

*Weight: 95 kg.*

*Capacity: 292 L.*

# WANDA

\_2011

design  
Daniel Debiasi  
Federico Sandri

I bordi sinuosi si alzano asimmetricamente su uno dei lati, quello naturalmente predisposto ad appoggiarvi la schiena. Le linee fluide accompagnano questa crescita assecondando il gesto del corpo che si immerge nella vasca. Dall'altra parte l'altezza rimane invariata a testimoniare lo sviluppo longitudinale della parte che ospita le gambe. Wanda esprime fin da subito la scansione gerarchica del progetto, con una scelta immediata e di facile lettura in merito al suo utilizzo. Ne rimane un oggetto scultoreo ed ergonomico, una vasca dall'immagine sinuosa, femminile, accattivante.

*The edges rise symmetrically on one side to naturally lean back upon. The flowing lines accompany this growth favoring the gesture of the body immersed in the bath. Wanda expresses the perfect Antoni Lupi concept. It remains a sculpture, an ergonomic object, a winding bath, feminine and attractive.*











H	P	L	art.
77,2	84	178	WANDA

Vasca da bagno ovale in Ceramilux, completa di piletta con sistema di scarico a pressione klik-clak, sifone e tubo flessibile.

Peso vasca: 120 kg.

Capacità: 384 L.

*Oval Ceramilux bathtub complete with drain and pressure plug, siphon and flexible hose.*

*Weight: 120 kg.*

*Capacity: 384 L.*

# SOLIDEA

2013

design  
Carlo  
Colombo

Nasce da una deformazione della materia. Parte da una forma, da una geometria, per assumerne un'altra. Trasformista, ibrida e per questo contemporanea, interprete di una materia mutevole, che si plasma per esprimere dinamismo. Si parte da una base rettangolare, dagli spigoli arrotondati; poi le pareti si deformano progressivamente e lentamente fino a raggiungere l'ovale del bordo della vasca. La materia si tende come fosse un telo elastico, le forze disegnano una nuova forma irregolare, ma fatta di armonia e nuovi equilibri proporzionali. Solidea è realizzata in Cristalplant o marmo ed esprime tutta la ricerca plastica di antoniolupi che si traduce in forme inedite ed evolute.

*This bathtub comes from a deformation of the material. It starts as one shape to finish in another. Transformer, hybrid and for this modern. Interpreter of a changeable matter molded to express dynamism. Beginning from a rectangular base with rounded edges; the walls deform gradually and slowly to reach the oval border of the bathtub. Matter stretches like an elastic cloth, forces design a new irregular shape yet harmonious and proportionally balanced. Solidea is made of Cristalplant or marble and expresses all the research by antoniolupi resulting in new and evolved forms.*



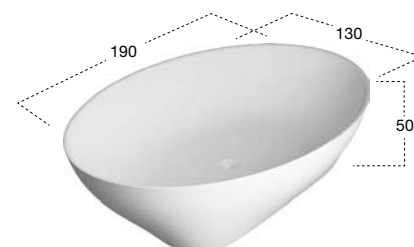

H	P	L	art.
50	130	190	SOLIDEA1

Vasca da bagno ovale in Cristalplant, completa di piletta con sistema di scarico a pressione clik-clak, sifone e tubo flessibile.

Peso vasca: 141 kg.

Capacità: 500 L.

*Oval Cristalplant bathtub complete with drain pipe fitting and pressure plug, siphon and flexible hose.*

*Weight: 141 kg.*

*Capacity: 500 L.*

# EDONIA

\_2014

design  
Mario  
Ferrarini

Una forma inedita, una base rettangolare che viene plasmata e “stirata” per modificarne la percezione e rendere meno statica la composizione. Una vasca senza tempo, comoda, elegante e pratica. Si parte da un blocco rettangolare, se ne addolciscono le linee, gli angoli, i bordi. Si curvano leggermente i lati, sia quelli lunghi che i due corti. Si alleggerisce l’immagine complessiva rialzando la vasca su quattro zampe angolari che la tengono sollevata da terra e generano negli spigoli un effetto “vela” che contribuisce ad accentuare la sensazione di leggerezza e dinamicità.

*An unusual shape, rectangular at its base, shaped and stretched to change its perception seemingly timeless, comfortable, elegant and practical. Starting from a rectangular block the lines, corners and edges are softened. It has slightly curved sides. The overall effect is very light and raised off the ground on four corner legs.*

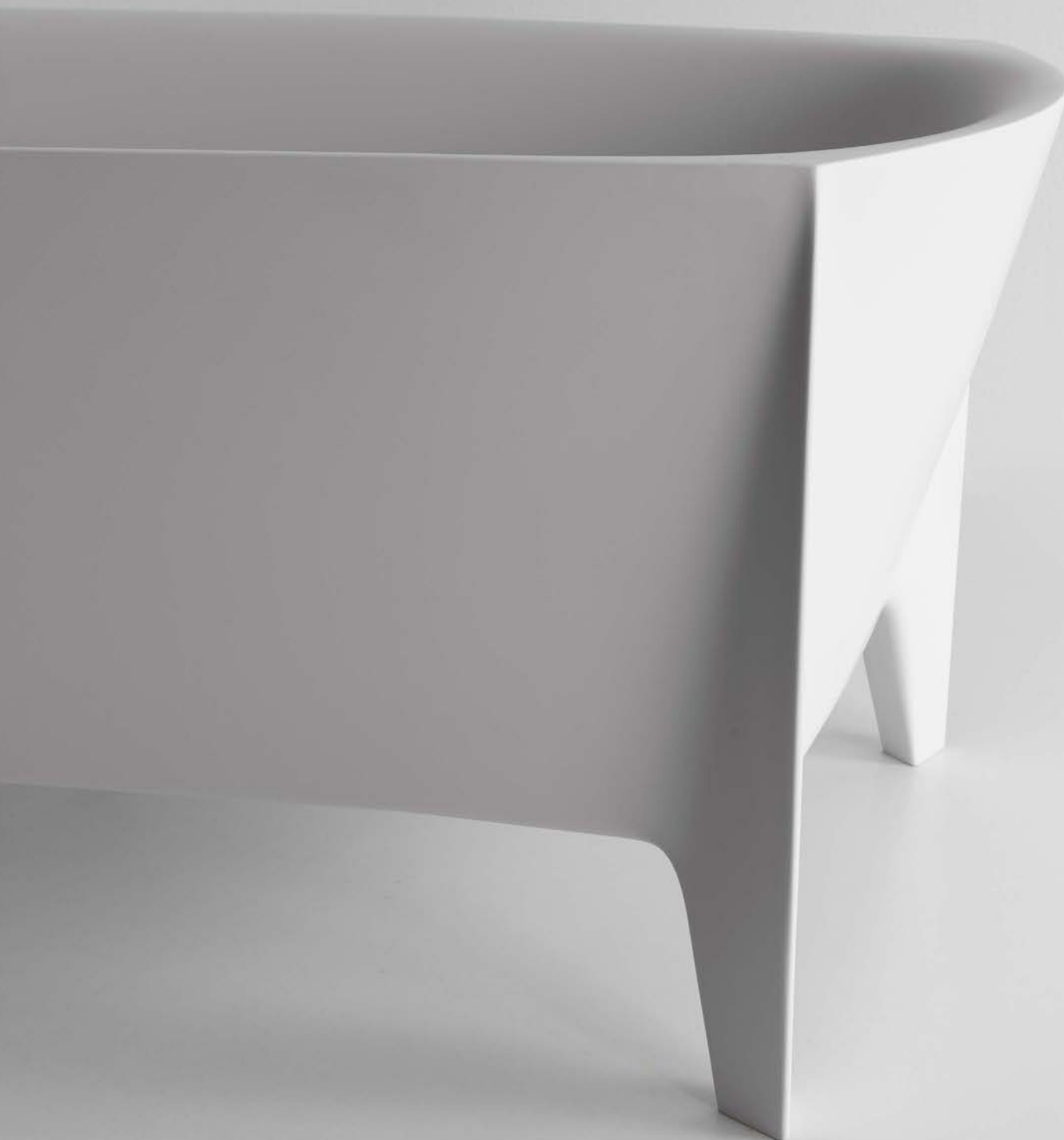



VASCHE  
TUBS







Verniciabile esternamente in tutti i colori del nostro campionario  
*Can be externally lacquered in all colors of our collection*

VASCHE  
TUBS



H	P	L	art.
60	76	172	EDONIA

Vasca da bagno rettangolare in Cristalplant con piedini, completa di piletta con sistema di scarico a pressione klik- clak, sifone e tubo flessibile.

Peso vasca: 125 kg.

Capacità: 272 L.

*Rectangular Cristalplant bathtub with feet, complete with drain with pressure plug, siphon and flexible tube.*

*Weight: 125 kg.*

*Capacity: 272 L.*

# SUITE

\_2014

design  
Roberto  
Lazzeroni

Effetto retrò, immagine che rimanda ad atmosfere lontane nel tempo ma rivista in chiave contemporanea, con personalità, stile e capacità di inserirsi in ambienti bagno di gusto borghese.

Morbida, avvolgente, testimone di un passato che si inserisce nel presente con personalità e identità. Realizzata in Cristalplant, Suite è la vasca dalle linee sinuose che trova nell'ampio bordo ripiegato all'indietro uno dei tratti distintivi. Un dettaglio che diventa simbolo, un elemento estetico e funzionale che delimita il perimetro della vasca e invita ad entrare, un segno forte che ne completa l'originale presenza insieme all'inedita forme della scocca e alla presenza dei piedini che la tengono sospesa da terra. Un dettaglio classico rivisitato e riattualizzato.

*Retro style, and image that remembers long ago but revised in a contemporary manner, with personality, style and ability to fit in the bathroom environments of a bourgeois taste.*

*Soft, enveloping, fitness of a past brought to the present with personality and identity. Made from Cristalplant, Suite is a bathtub with sinuous lines and large fold back as its main features. A detail that becomes a symbol, an aesthetic and functional element that defines the perimeter of the bathtub and invites you to enter. A strong sign that completes the presence of an original and new shell shape with legs. A classical revisited and refreshed idea.*



VASCHE  
TUBS





Verniciabile esternamente in tutti i colori del nostro campionario  
*Can be externally lacquered in all colors of our collection*

H	P	L	art.
78	90	192	SUITE248
78	90	192	SUITE310

Vasca da bagno ovale in Cristalplant con piedini, completa di piletta con sistema di scarico a pressione klik- clak, sifone e tubo flessibile.

Art. SUITE248

Peso vasca: 80 kg.

Capacità: 248 L.

Art. SUITE310

Peso vasca: 80 kg.

Capacità: 310 L.

*Oval Cristalplant bathtub with feet, complete with drain with pressure plug, siphon and flexible tube.*

*Art. SUITE248*

*Weight: 80 kg.*

*Capacity: 248 L.*

*Art. SUITE310*

*Weight: 80 kg.*

*Capacity: 310 L.*



# SARTO

\_2008

design  
Carlo  
Colombo

Il trasformismo è il suo mestiere, la versatilità delle forme il modo di esprimersi, la capacità di interpretare qualsiasi esigenza progettuale la sua vera forza. Sartoriale, di nome e di fatto. Freestanding, totalmente o parzialmente incassata, rettangolare nel suo volume pulito o morbida nel suo inserirsi nello spazio, insomma capace di assumere forme e composizioni diverse per soddisfare qualsiasi esigenza del progetto, sia dal punto di vista stilistico, sia per quanto riguarda il suo inserimento dello spazio. La disposizione asimmetrica del bacino della vasca rispetto al volume complessivamente occupato determina di fatto una gerarchia dei fronti e dal punto di vista funzionale un bordo di dimensioni considerevoli che diventa pratico piano d'appoggio. Nella versione freestanding la possibilità di presentare l'intero blocco vasca o al contrario di lasciare il bacino nudo determina un aspetto scultoreo differente, quasi come se la forma fosse ottenuta per sottrazione modellando un blocco grezzo.

*Transformation at its best, versatility of shape and expression, the ability to interpret any project requirement are a few strengths. Tailoring, in name and in fact. Freestanding, totally or partially recessed capable of assuming different shapes and compositions to meet all needs of the project. In the freestanding version, the opportunity of presenting the entire block as opposed to leaving the bowl bare determines a different sculptural appearance almost as if the shape was obtained by subtraction molding a rough block of material.*





H	P	L	art.
55	140	200	SARTO MAXI2

Vasca da bagno rettangolare freestanding o da incasso in Cristalplant completa di piletta con scarico a pressione klik-clak, sifone e tubo flessibile.

Peso vasca: 157 kg.

Capacità: 511 L.

*Rectangular Cristalplant freestanding or encased bathtub, complete with drain and pressure plug, siphon and flexible hose.*

*Weight: 157 kg.*

*Capacity: 511 L.*

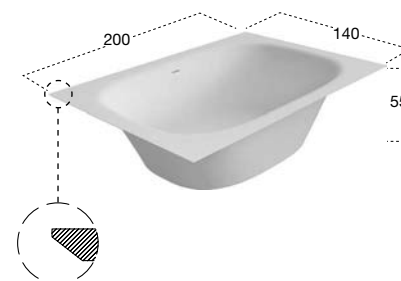





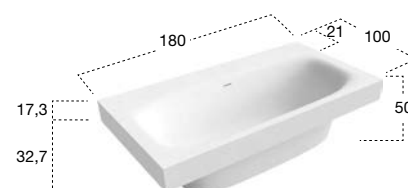
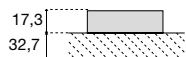

H	P	L	art.
50	100	180	SARTO36

Vasca da bagno rettangolare a semincasso in Cristalplant, con bordo per rubinetteria sul retro, completa di piletta con scarico a pressione klik-clak, sifone e tubo flessibile.

Peso vasca: 152 kg.

Capacità: 290 L.

*Semi-encased rectangular Cristalplant bathtub with back rim for tap mounting, complete with drain and pressure plug, siphon and flexible hose.*

*Weight: 152 kg.*

*Capacity: 290 L.*





Verniciabile esternamente in tutti i colori del nostro campionario  
*Can be externally lacquered in all colors of our collection*

VASCHE  
 TUBS

H	P	L	art.
50	100	190	SART015

Vasca da bagno ovale freestanding o da incasso in Cristalplant, con bordo per rubinetteria sul retro completa di piletta con scarico a pressione klik-clak, sifone e tubo flessibile.

Peso vasca: 130 kg.

Capacità: 290 L.

*Oval Cristalplant freestanding or encased bathtub with back rim for tap mounting, complete with drain and pressure plug, siphon and flexible hose.*

*Weight: 130 kg.*

*Capacity: 290 L.*

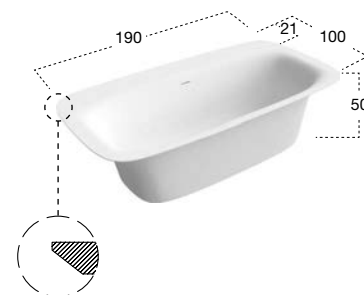

# SARTO

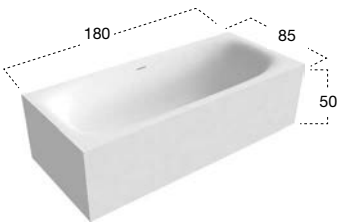

H	P	L	art.
50	85	180	SARTO47

Vasca da bagno rettangolare freestanding in Cristalplant completa di piletta con sistema di scarico a pressione clik-clak, sifone e tubo flessibile.  
Peso vasca: 183 kg.  
Capacità: 290 L.

*Rectangular Cristalplant freestanding bathtub, complete with drain and pressure plug, siphon and flexible hose.  
Weight: 183 kg.  
Capacity: 290 L.*

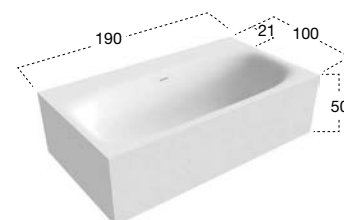

H	P	L	art.
50	100	190	SART017

Vasca da bagno rettangolare freestanding in Cristalplant, con bordo per rubinetteria sul retro, completa di piletta con scarico a pressione klik-clak, sifone e tubo flessibile.

Peso vasca: 203 kg.

Capacità: 290 L.

*Rectangular Cristalplant freestanding bathtub with back rim for tap mounting, complete with drain and pressure plug, siphon and flexible hose.*

*Weight: 203 kg.*

*Capacity: 290 L.*



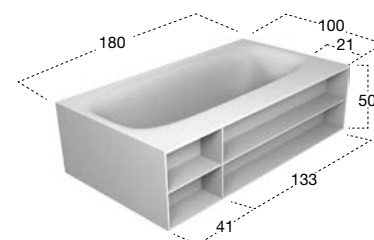

H	P	L	art.
50	100	180	SART053

Vasca da bagno rettangolare in Cristalplant, con vani a giorno frontali dx o sx e piletta con scarico a pressione clik-clak.

Peso vasca: 240 kg.

Capacità: 290 L.

*Rectangular Cristalplant bathtub with front, right or left open compartments and pressure drain.*

*Weight: 240 kg.*

*Capacity: 290 L.*

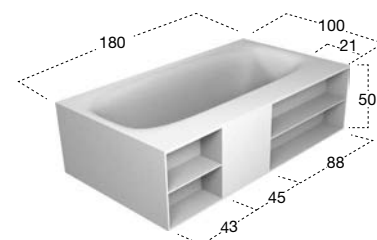

H	P	L	art.
50	100	180	SART0153

Vasca da bagno rettangolare in Cristalplant con vani a giorno frontali, alloggiamento per rubinetteria dx o sx e piletta con scarico a pressione clik-clak.

Peso vasca: 260 kg.

Capacità: 290 L.

*Rectangular Cristalplant bathtub with front open compartments, right or left tap border and pressure drain.*

*Weight: 260 kg.*

*Capacity: 290 L.*



# SARTORIALE

## art. SART015

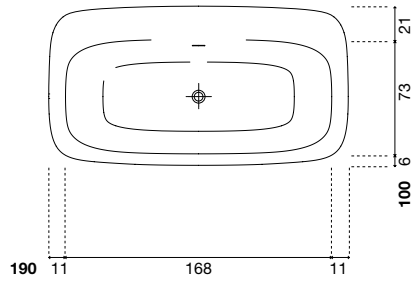

**SART015** H 50 P 100 L 190



## art. SART040/20

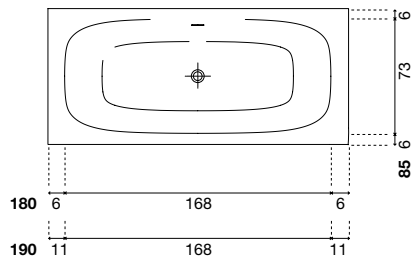

**SART040** H 50 P 85 H L 180  
**SART020** H 50 P 85 H L 190

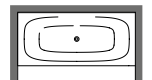
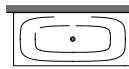

## art. SART030/10

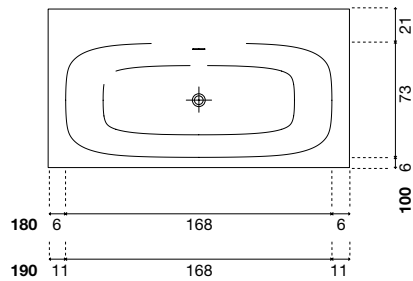

**SART030** H 50 P 100 L 180  
**SART010** H 50 P 100 L 190

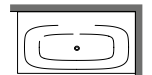
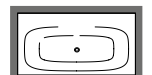
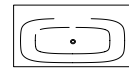

## art. SART046

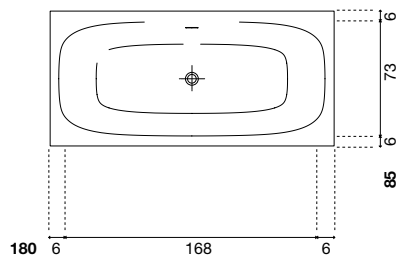

**SART046** H 50 P 85 L 180

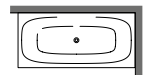
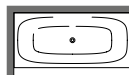
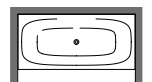
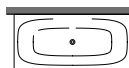
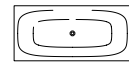
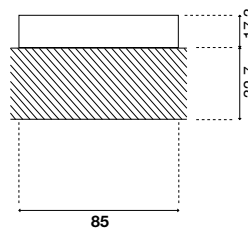

VASCHE  
TUBS

art. SART036



SART036 H 50 P 100 L 180

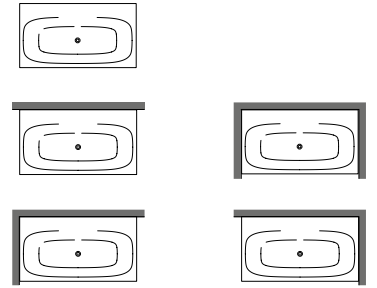
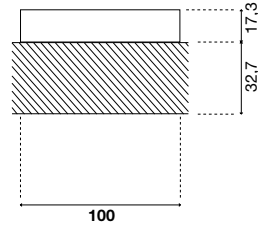
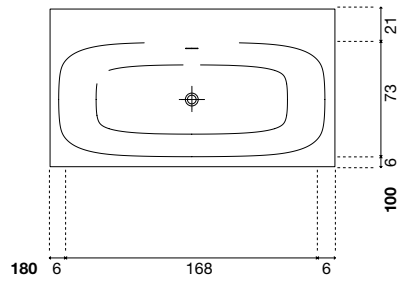

art. SART047/27



SART047 H 50 P 85 L 180  
SART027 H 50 P 85 L 190

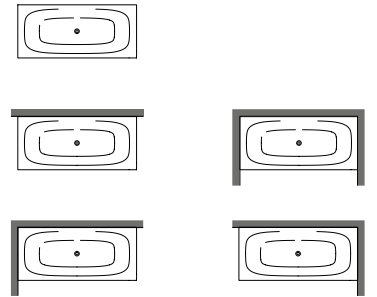
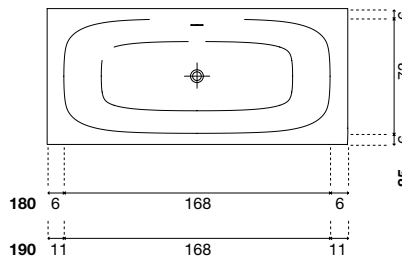

art. SART037/17



SART037 H 50 P 100 L 180  
SART017 H 50 P 100 L 190

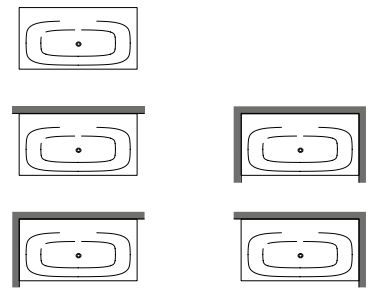
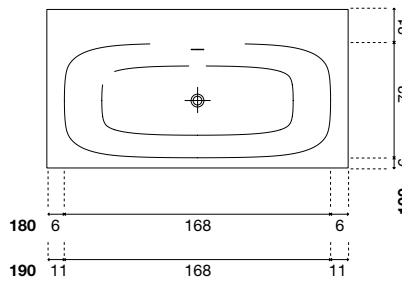

art. SARTO MAXI2



SARTO MAXI2 H 55 P 140 L 200

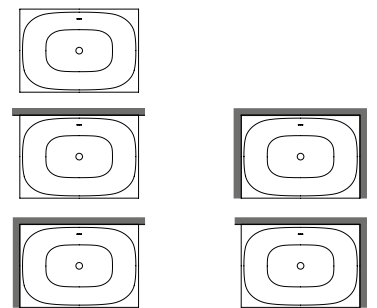
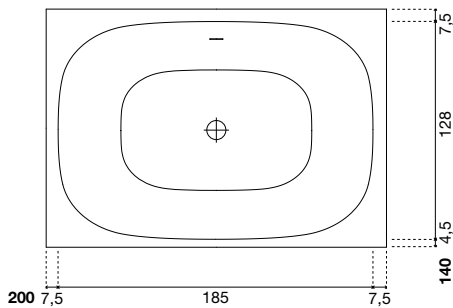

art. SART053

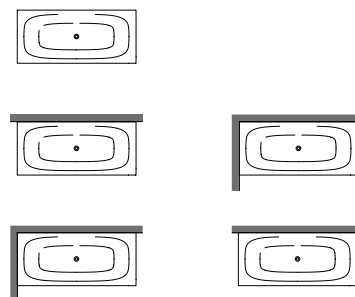
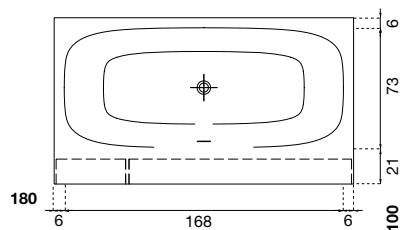

art. SART053 H 50 P 100 L 180

art. SART0153

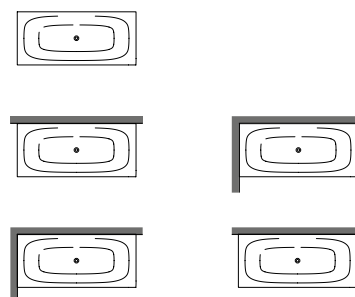
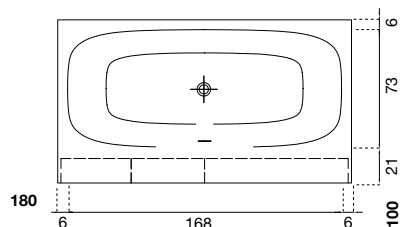

art. SART0153 L 180 P 100 H 50

## POSIZIONAMENTO RUBINETTERIA / TAP POSITION

Vista dall'alto e laterale del posizionamento del rubinetto sul bordo da 21 cm lato lungo vasca opzioni **A-B** degli Art. **BK701**, **AY701SA** e **AY701LU**.

Top and side view of tap position on border 21 cm. long side options **A-B** of Art. **BK701**, **AY701SA** and **AY701LU**.

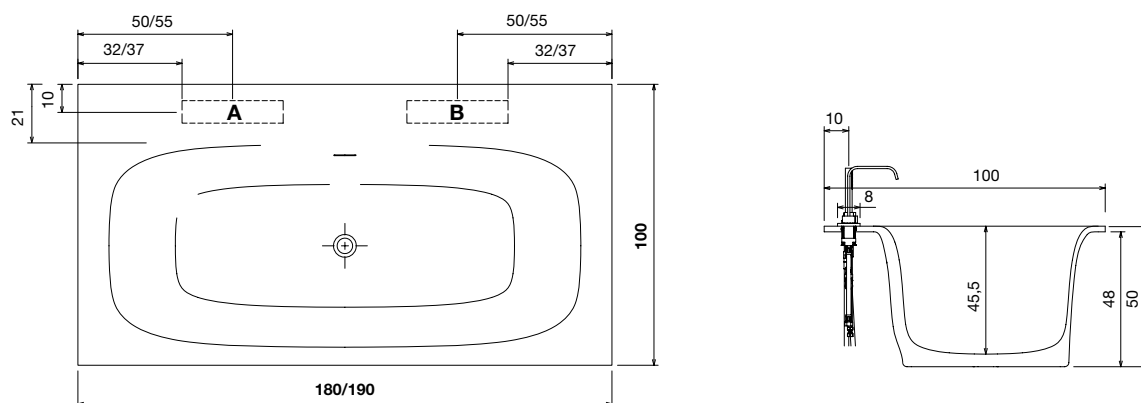

art. BK701

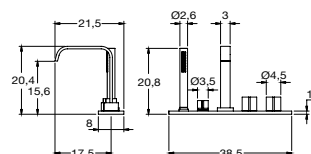

art. AY701SA  
art. AY701LU

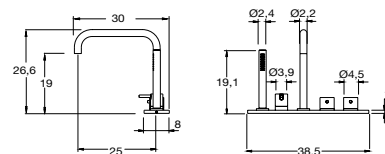

# BIBLIO

\_2007

design  
Nevio  
Tellatin

Ampia, rigorosa nella sua geometria pura, negli spigoli vivi, nel linguaggio essenziale. Ricca, di nuovi significati, di spazi accessori, di superfici d'appoggio. Biblio è realizzata in Corian e può ospitare lungo due lati funzionali una serie di vani a giorno per riporre libri, oggetti e accessori. Spazi utili per organizzare lo spazio ma anche per personalizzare l'esperienza, volumi ricavati nel fianco che si allarga e diventa un pratico piano d'appoggio. Versatile perché può essere posizionata free standing o incassata, può integrare un piano rialzato a cui accedere con uno scalino. Democratica, perché può essere inoltre accostata a parte su qualsiasi lato, scegliendo il fronte tradizionale o quello nel quale sono ospitati i libri. Personalizzabile, perché la piccola libreria integrata può assumere un carattere diverso qualora venga rivestita con essenze o definita da colori particolari.

*Large, rigorous in its pure shape with sharp corners. Rich with new meanings, space for accessories and surfaces. Biblio is made of Corian and can accommodate along two sides open compartments for books, objects and accessories. Useful spaces to organize and personalize your experience. Versatile because can be freestanding or embedded, democratic because approachable by either side. Customizable because the small built in library can take on a different character if covered with wood.*





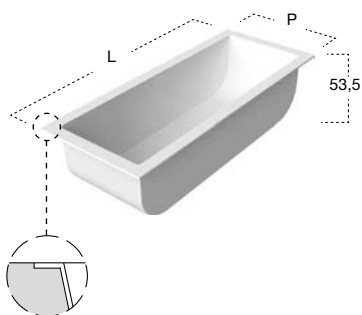

H	P	L	art.
53,5	70	170	BIBLI010
	80	180	BIBLI011

Vasca da bagno rettangolare da incasso in Corian, completa di piedini regolabili e piletta con scarico a pressione klik-clak.  
 Art. BIBLI010  
 Peso vasca: 81 kg.  
 Capacità: 288 L.  
 Art. BIBLI011  
 Peso vasca: 82 kg.  
 Capacità: 362 L.

*Encased rectangular Corian bathtub, complete with regulating feet and drain with pressure plug.  
 Art. BIBLI010  
 Weight: 81 kg.  
 Capacity: 288 L.  
 Art. BIBLI011  
 Weight: 82 kg.  
 Capacity: 362 L.*



H	P	L	art.
53,5	80	170	BIBLIO20
	90	180	BIBLIO21

Vasca da bagno rettangolare da incasso in Corian, con bordo per rubinetteria sul retro, completa di piedini regolabili e piletta con scarico a pressione klik-clak.

Art. BIBLIO20

Peso vasca: 75 kg.

Capacità: 288 L.

Art. BIBLIO21

Peso vasca: 90 kg.

Capacità: 362 L.

*Encased rectangular Corian bathtub with back rim for tap mounting, complete with regulating feet and drain with pressure plug.*

*Art. BIBLIO20*

*Weight: 75 kg.*

*Capacity: 288 L.*

*Art. BIBLIO21*

*Weight: 90 kg.*

*Capacity: 362 L.*

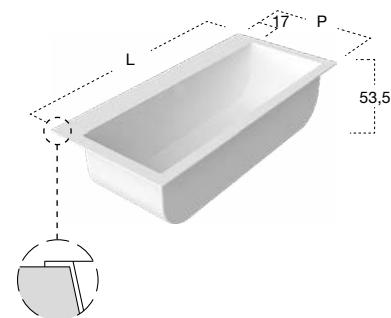

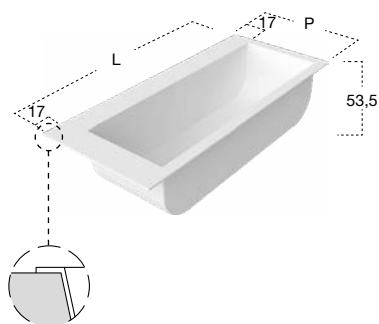

H	P	L	art.
53,5	80	180	BIBLI030
	90	190	BIBLI031

Vasca da bagno rettangolare da incasso in Corian, con bordo per rubinetteria sul retro e laterale dx o sx, completa di piedini regolabili e piletta con scarico a pressione klik-clak.  
 Art. BIBLI030  
 Peso vasca: 92 kg.  
 Capacità: 288 L.  
 Art. BIBLI031  
 Peso vasca: 95 kg.  
 Capacità: 362 L.

*Encased rectangular Corian bathtub with back and right or left side rim for tap mounting, complete with regulating feet and drain with pressure plug.  
 Art. BIBLI030  
 Weight: 92 kg.  
 Capacity: 288 L.  
 Art. BIBLI031  
 Weight: 95 kg.  
 Capacity: 362 L.*



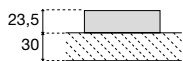

	H	P	L	art.
	53,5	80	180	BIBLIO80
		90	190	BIBLIO81

Vasca da bagno rettangolare da incasso in Corian, completa di piedini regolabili e piletta con scarico a pressione clik-clak.

Art. BIBLIO80

Peso vasca: 105 kg.

Capacità: 288 L.

Art. BIBLIO81

Peso vasca: 121 kg.

Capacità: 362 L.

*Encased rectangular Corian bathtub, complete with regulating feet and drain with pressure plug.*

*Art. BIBLIO80*

*Weight: 105 kg.*

*Capacity: 288 L.*

*Art. BIBLIO81*

*Weight: 121 kg.*

*Capacity: 362 L.*

art. BRIDGE

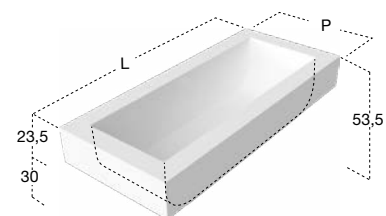

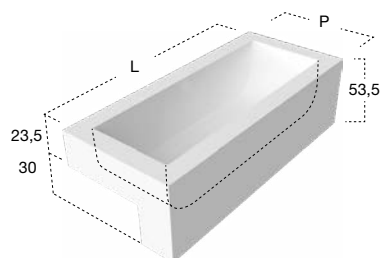
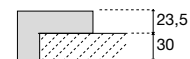

art. BRIDGE

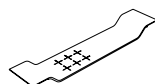

H	P	L	art.
53,5	80	180	BIBLI070
	90	190	BIBLI071

Vasca da bagno rettangolare da semincasso frontale in Corian, completa di piedini regolabili e piletta con scarico a pressione klik-clak.

Art. BIBLI070

Peso vasca: 118 kg.

Capacità: 288 L.

Art. BIBLI071

Peso vasca: 131 kg.

Capacità: 362 L.

*Semi-encased rectangular Corian bathtub complete with regulating feet and drain with pressure plug.*

*Art. BIBLI070*

*Weight: 118 kg.*

*Capacity: 288 L.*

*Art. BIBLI071*

*Weight: 131 kg.*

*Capacity: 362 L.*

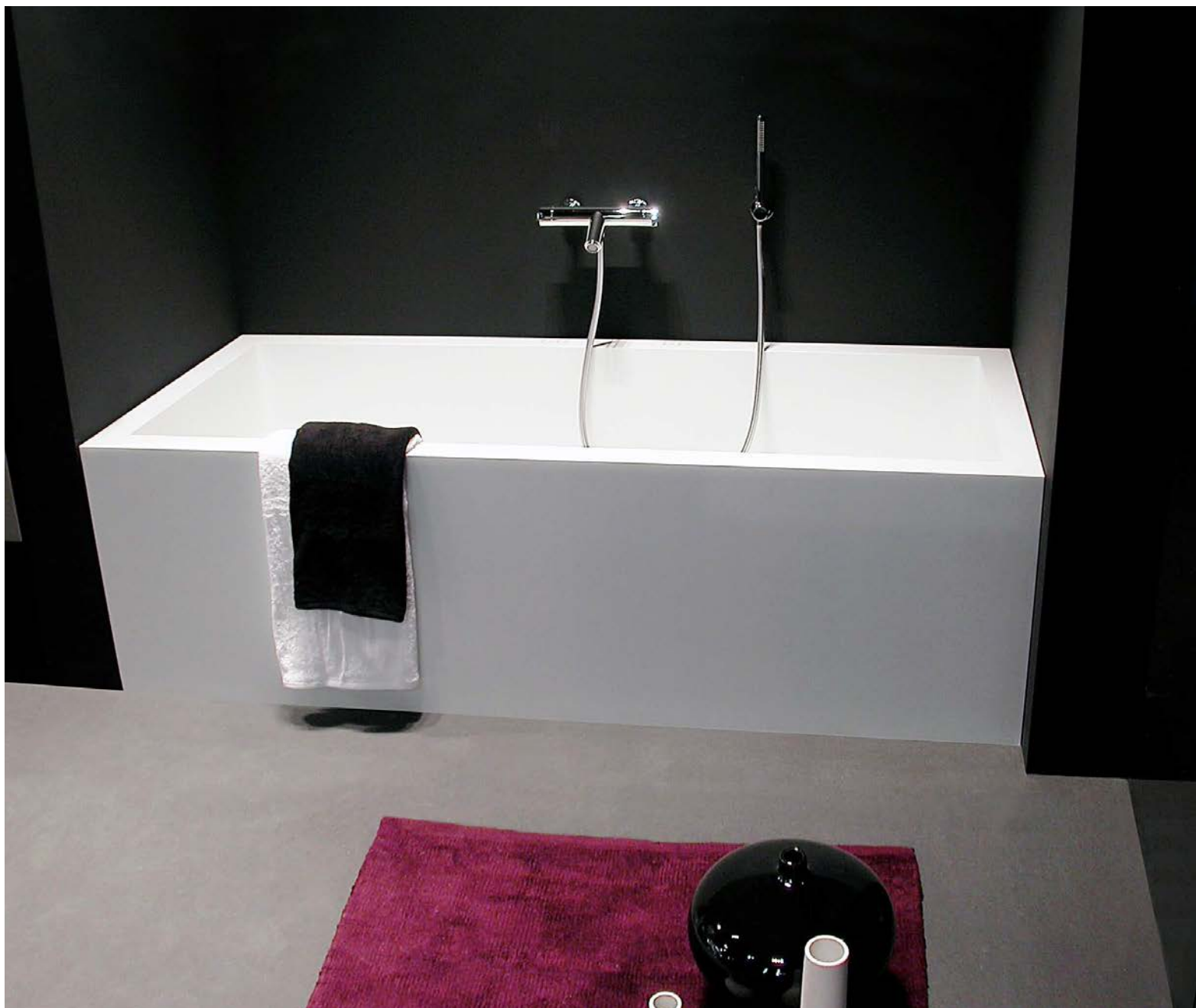

H	P	L	art.
53,5	70	170	BIBLIO12
	80	180	BIBLIO13

Vasca da bagno rettangolare in Corian, completa di piedini regolabili e piletta con scarico a pressione klik-clak.

Art. BIBLIO12

Peso vasca: 101 kg.

Capacità: 288 L.

Art. BIBLIO13

Peso vasca: 142 kg.

Capacità: 362 L.

*Rectangular Corian bathtub, complete with regulating feet and drain with pressure plug.*

*Art. BIBLIO12*

*Weight: 101 kg.*

*Capacity: 288 L.*

*Art. BIBLIO13*

*Weight: 142 kg.*

*Capacity: 362 L.*

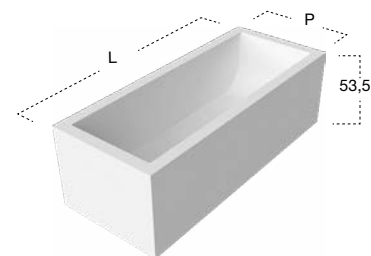

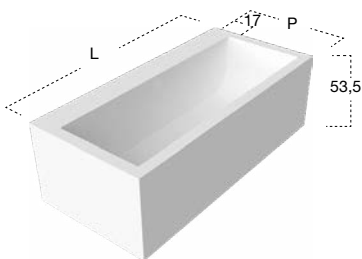

art. BRIDGE

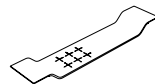

H	P	L	art.
53,5	80	170	BIBLIO22
	90	180	BIBLIO23

Vasca da bagno rettangolare in Corian, con bordo per rubinetteria sul retro, completa di piedini regolabili e piletta con scarico a pressione klik-clak.  
 Art. BIBLIO22  
 Peso vasca: 152 kg.  
 Capacità: 288 L.  
 Art. BIBLIO23  
 Peso vasca: 160 kg.  
 Capacità: 362 L.

*Rectangular Corian bathtub with back rim for tap mounting, complete with regulating feet and drain with pressure plug.  
 Art. BIBLIO22  
 Weight: 152 kg.  
 Capacity: 288 L.  
 Art. BIBLIO23  
 Weight: 160 kg.  
 Capacity: 362 L.*



H	P	L	art.
53,5	90	180	BIBLI062
	100	190	BIBLI063

Vasca da bagno rettangolare in Corian con vani a giorno frontali e bordo per rubinetteria laterale dx o sx, completa di piedini regolabili e piletta con scarico a pressione klik-clak.

Art. BIBLI062

Peso vasca: 158 kg.

Capacità: 288 L.

Art. BIBLI063

Peso vasca: 167 kg.

Capacità: 362 L.

*Rectangular Corian bathtub with front open shelves and right or left side rim for tap mounting, complete with regulating feet and drain with pressure plug.*

*Art. BIBLI062*

*Weight: 158 kg.*

*Capacity: 288 L.*

*Art. BIBLI063*

*Weight: 167 kg.*

*Capacity: 362 L.*

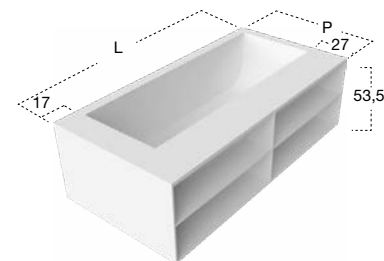





H	P	L	art.
53,5	90	170	BIBLI052
	100	180	BIBLI053

Vasca da bagno rettangolare in Corian, con vani a giorno frontali, completa di piedini regolabili e piletta con scarico a pressione klik-clak.

Art. BIBLI052

Peso vasca: 128 kg.

Capacità: 288 L.

Art. BIBLI053

Peso vasca: 133 kg.

Capacità: 362 L.

*Rectangular Corian bathtub with front open shelves, complete with regulating feet and drain with pressure plug.*

*Art. BIBLI052*

*Weight: 128 kg.*

*Capacity: 288 L.*

*Art. BIBLI053*

*Weight: 133 kg.*

*Capacity: 362 L.*

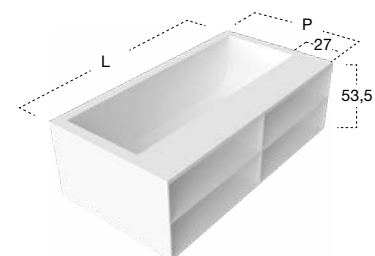

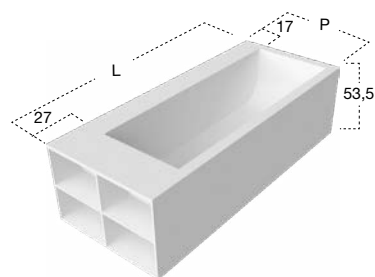

H	P	L	art.
53,5	80	190	BIBLI042
	90	200	BIBLI043

Vasca da bagno rettangolare in Corian, con bordo per rubinetteria sul retro e vani a giorno laterali dx o sx, completa di piedini regolabili e piletta con scarico a pressione klik-clak.  
 Art. BIBLI042  
 Peso vasca: 129 kg.  
 Capacità: 288 L.  
 Art. BIBLI043  
 Peso vasca: 138 kg.  
 Capacità: 362 L.

*Rectangular Corian bathtub with back rim for tap mounting and right or left side open shelves, complete with regulating feet and drain with pressure plug.  
 Art. BIBLI042  
 Weight: 129 kg.  
 Capacity: 288 L.  
 Art. BIBLI043  
 Weight: 138 kg.  
 Capacity: 362 L.*





H	P	L	art.
53,5	80	190	BIBLIO44
	90	200	BIBLIO45

Vasca da bagno rettangolare in Corian, con bordo per rubinetteria sul retro e vani a giorno laterali dx o sx, rivestita su 4 lati con pannelli in multistrato impiallacciati in essenza di legno, completa di piedini regolabili e piletta con scarico a pressione clik-clak.

Art. BIBLIO44

Peso vasca: 135 kg.

Capacità: 288 L.

Art. BIBLIO45

Peso vasca: 152 kg.

Capacità: 362 L.

Rectangular Corian bathtub with back rim for tap mounting and right or left side open shelves, covered on 4 sides with plywood panels veneered with wood essence complete with regulating feet and drain with pressure plug.

Art. BIBLIO44

Weight: 135 kg.

Capacity: 288 L.

Art. BIBLIO45

Weight: 152 kg.

Capacity: 362 L.

art. BRIDGE

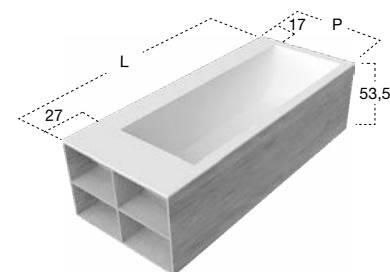



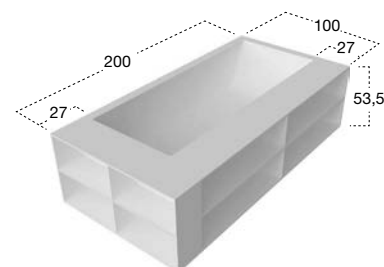

H	P	L	art.
53,5	100	200	BIBLIO103

Vasca da bagno rettangolare in Corian con vani a giorno frontali e laterali, completa di piedini regolabili e piletta con scarico a pressione klik-clak.

Peso vasca: 121 kg.

Capacità: 362 L.

*Rectangular Corian bathtub with front and lateral open shelves, complete with regulating feet and drain with pressure plug.*

*Weight: 121 kg.*

*Capacity: 362 L.*



H	P	L	art.
53,5	90	180	BIBLI064
	100	190	BIBLI065

Vasca da bagno rettangolare in Corian, con vani a giorno frontali e bordo per rubinetteria dx o sx, rivestita su 4 lati con pannelli in multistrato impiallacciati in essenza di legno, completa di piedini regolabili e piletta con scarico a pressione klik-clak.

Art. BIBLI064

Peso vasca: 122 kg.

Capacità: 288 L.

Art. BIBLI065

Peso vasca: 133 kg.

Capacità: 362 L.

*Rectangular Corian bathtub with front open shelves and right or left side rim for tap mounting, covered on 4 sides with plywood panels veneered with wood essence complete with regulating feet and drain with pressure plug.*

*Art. BIBLI064*

*Weight: 122 kg.*

*Capacity: 288 L.*

*Art. BIBLI065*

*Weight: 133 kg.*

*Capacity: 362 L.*

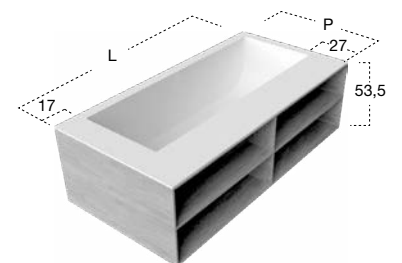

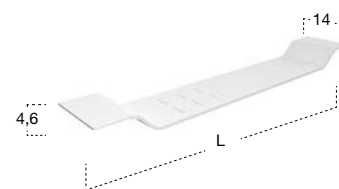

VASCHE  
TUBS

H	P	L	art.
4,6	14	70	BRIDGE10
4,6	14	80	BRIDGE11

Tavoletta sagomata in Corian portaoggetti, per vasca da bagno Art. BIBLIO.

Corian soap tray for bathtub Art. BIBLIO.

# BIBLIO

## art. BIBLIO10/11/12/13/14/15

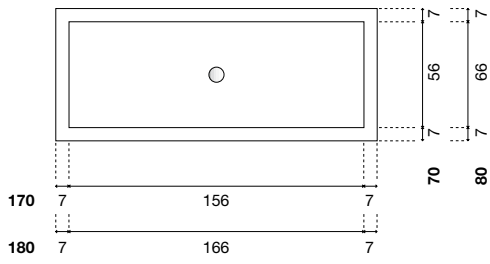

**BIBLIO10** H 53,5 P 70 L 170 cm  
**BIBLIO11** H 53,5 P 80 L 180 cm

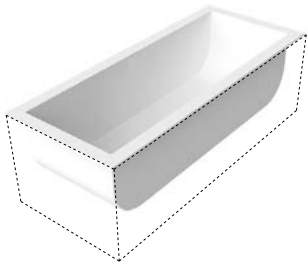

**BIBLIO12** H 53,5 P 70 L 170 cm  
**BIBLIO13** H 53,5 P 80 L 180 cm

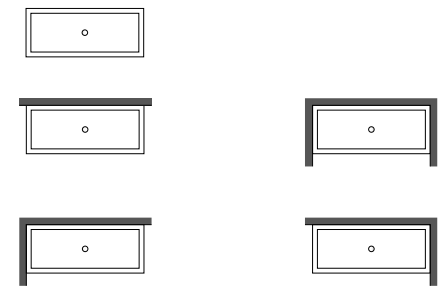

**BIBLIO14** H 53,5 P 70 L 170 cm  
**BIBLIO15** H 53,5 P 80 L 180 cm



## art. BIBLIO20/21/22/23/24/25

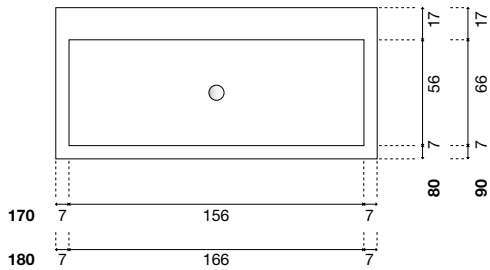

**BIBLIO20** H 53,5 P 80 L 170 cm  
**BIBLIO21** H 53,5 P 90 L 180 cm

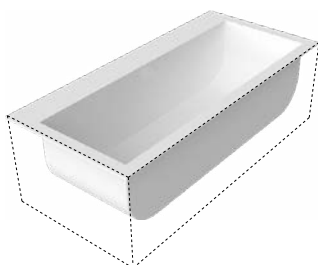

**BIBLIO22** H 53,5 P 80 L 170 cm  
**BIBLIO23** H 53,5 P 90 L 180 cm



**BIBLIO24** H 53,5 P 80 L 170 cm  
**BIBLIO25** H 53,5 P 90 L 180 cm



art. BIBLIO30/31/32/33/34/35

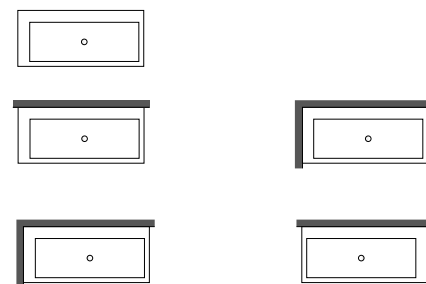
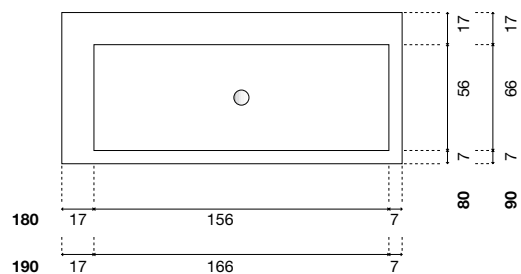

**BIBLIO30** H 53,5 P 80 L 180 cm  
**BIBLIO31** H 53,5 P 90 L 190 cm

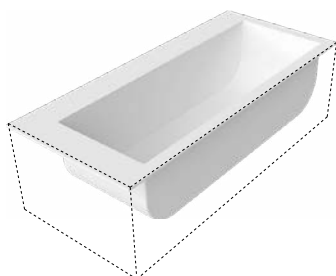

**BIBLIO32** H 53,5 P 80 L 180 cm  
**BIBLIO33** H 53,5 P 90 L 190 cm



**BIBLIO34** H 53,5 P 80 L 180 cm  
**BIBLIO35** H 53,5 P 90 L 190 cm



art. BIBLIO42/43/44/45

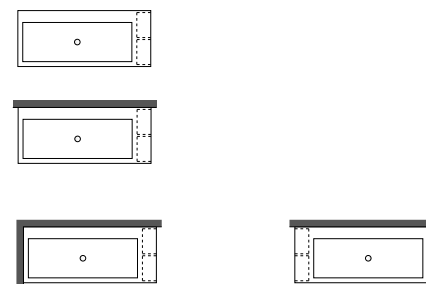
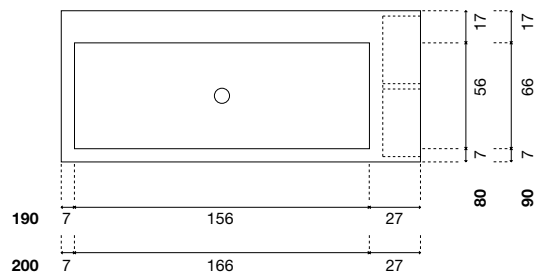

**BIBLIO42** H 53,5 P 80 L 190 cm  
**BIBLIO43** H 53,5 P 90 L 200 cm

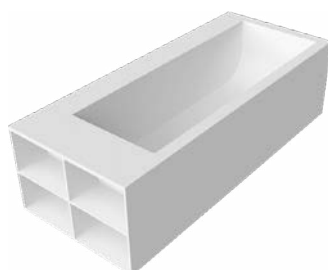

**BIBLIO44** H 53,5 P 80 L 190 cm  
**BIBLIO45** H 53,5 P 90 L 200 cm

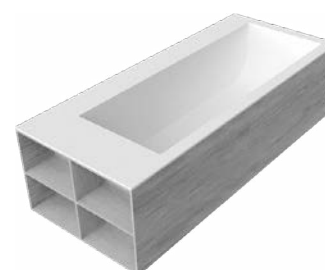

# BIBLIO

art. BIBLI052/53/54/55

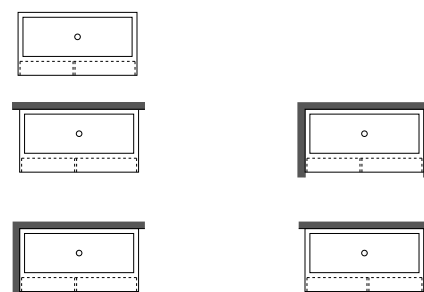
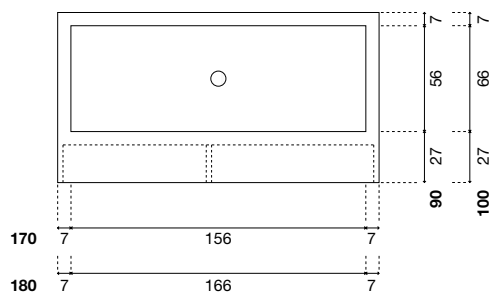

**BIBLI052** H 53,5 P 90 L 170 cm  
**BIBLI053** H 53,5 P 100 L 180 cm

**BIBLI054** H 53,5 P 90 L 170 cm  
**BIBLI055** H 53,5 P 100 L 180 cm



art. BIBLI060/61/62/63/64/65

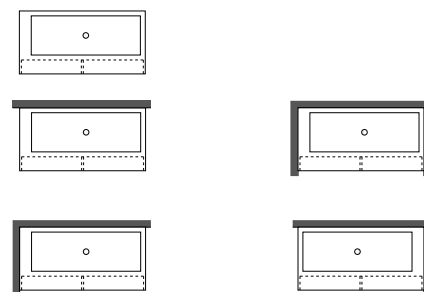
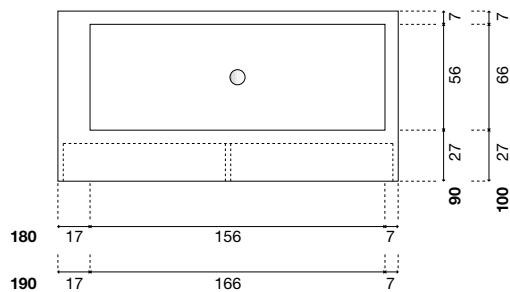

**BIBLI060** H 53,5 P 90 L 180 cm  
**BIBLI061** H 53,5 P 100 L 190 cm

**BIBLI062** H 53,5 P 90 L 180 cm  
**BIBLI063** H 53,5 P 100 L 190 cm

**BIBLI064** H 53,5 P 90 L 180 cm  
**BIBLI065** H 53,5 P 100 L 190 cm

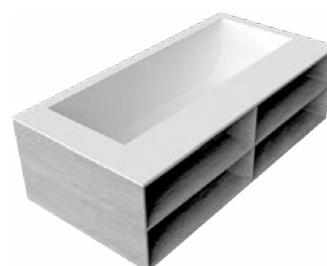
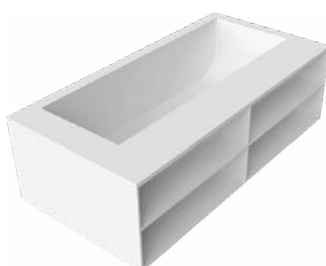
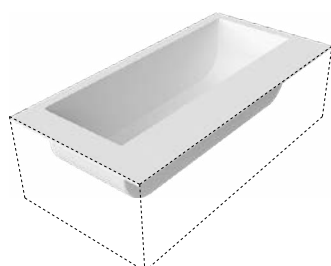



art. BIBLI070/71

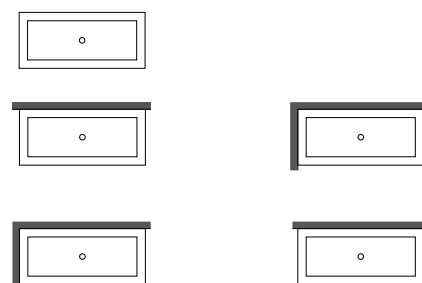
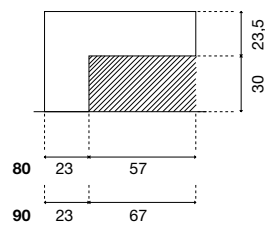
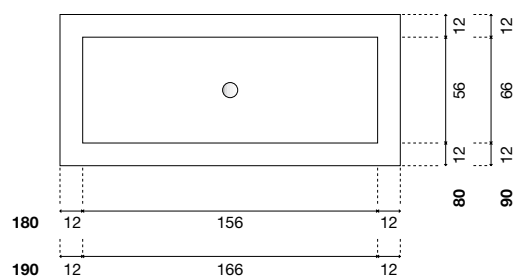

**BIBLI070** H 53,5 P 80 L 180 cm

**BIBLI071** H 53,5 P 90 L 190 cm

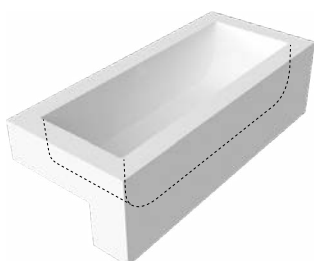

art. BIBLI080/81

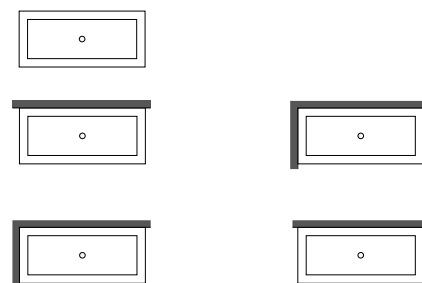
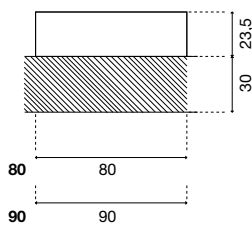
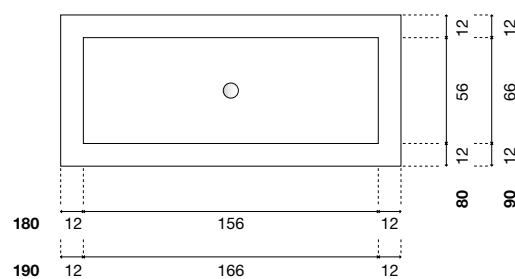

**BIBLI080** H 53,5 P 80 L 180 cm

**BIBLI081** H 53,5 P 90 L 190 cm



# BIBLIO

art. **BIBLIO103**

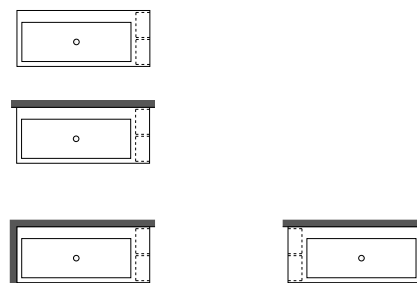
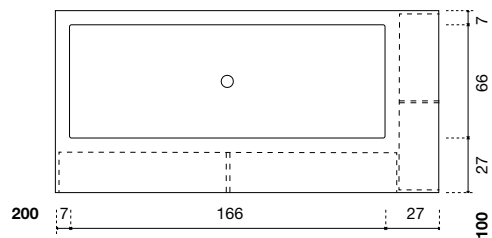

**BIBLIO103** H 53,5 P 100 L 200 cm



Vista dall'alto del posizionamento del rubinetto sul bordo da 17 cm lato lungo vasca opzioni **A-B-C** degli Art. **BK701, BK702, AY701SA, AY701LU, AY702SA, AY702LU, ND702LU, ND702SA e ND702GR.**

*Top view of tap position on border 17 cm long side options **A-B-C** of Art. **BK701, BK702, AY701SA, AY701LU, AY702SA, AY702LU, ND702LU, ND702SA and ND702GR.***

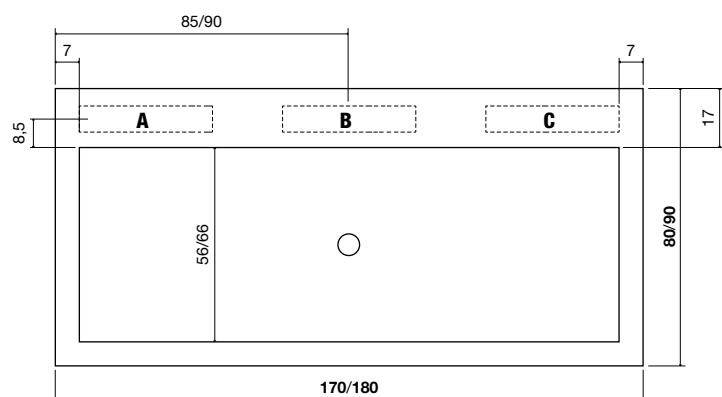

Vista dall'alto e laterale del posizionamento del rubinetto sul bordo da 17 cm lato corto vasca degli Art. **BK701, BK702, AY701SA, AY701LU, AY702SA, AY702LU, ND702LU, ND702SA e ND702GR.**

*Top and side view of tap position on center of border 17 cm short side of Art. **BK701, BK702, AY701SA, AY701LU, AY702SA, AY702LU, ND702LU, ND702SA and ND702GR.***

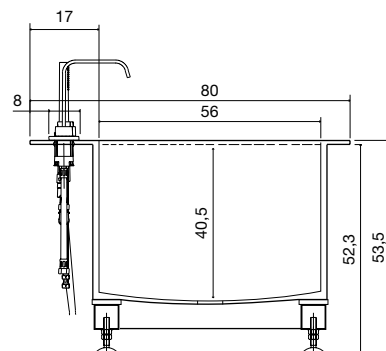
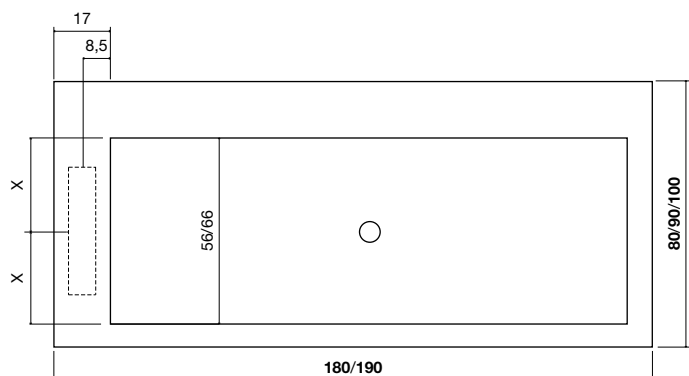

# BIBLIO

art. BK701

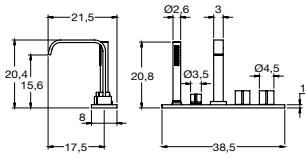

art. AY701SA  
art. AY701LU

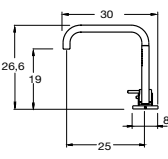

art. BK702

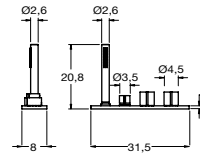
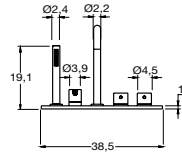

art. AY702SA  
art. AY702LU

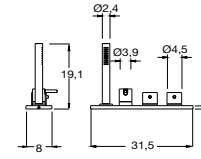

art. ND702SA  
art. ND702LU  
art. ND702GR

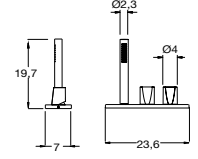

Tutti i modelli Art. **BIBLIO** sono corredati di un sistema di scarico illustrato di seguito, completo di troppopieno nascosto che funziona mediante l'utilizzo del principio dei vasi comunicanti (A), sifone (D), e piletta con scarico a pressione "klik-clak", che può svolgere anche la funzione di erogazione (B), da attivare solo in abbinamento ai rubinetti Art. **BK702**, **AY702SA**, **AY702LU**, **ND702SA**, **ND702LU** e **ND702GR** o a qualsiasi rubinetto bordo vasca sprovvisto di bocca di erogazione.

All models of the Art. **BIBLIO** bathtub come with a drainage system as illustrated below complete with a hidden overflow which functions utilizing the connection tubes (A), trap (D) and pressure plug which can also be used as a spout (B), to activate only in conjunction with Art. **BK702**, **AY702SA**, **AY702LU**, **ND702SA**, **ND702LU** and **ND702GR** or any bath rim mounting set without a bath spout according to instructions given below.

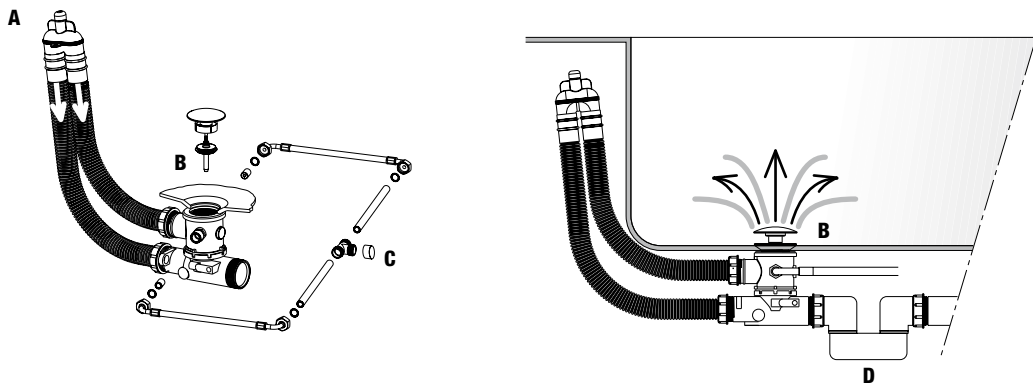

art. BK702

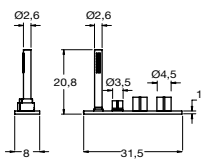

art. AY702SA  
art. AY702LU

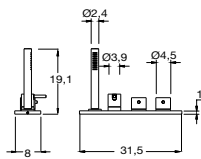

art. ND702SA  
art. ND702LU  
art. ND702GR

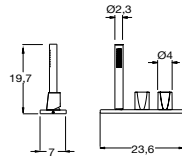

Con Art. **BK702** / **AY702SA** / **AY702LU** / **ND702LU** / **ND702SA** / **ND702GR**  
Per rendere attivo il sistema di erogazione direttamente dalla piletta di scarico (B), togliere il tappo "C" e collegare al carico dell'acqua.

With Art. **BK702** / **AY702SA** / **AY702LU** / **ND702LU** / **ND702SA** / **ND702GR**  
Remove cap "C" and connect to water outlet to activate directly from drain (B).

# SOLIDEA

2013

design  
Carlo  
Colombo





VASCHE  
TUBS



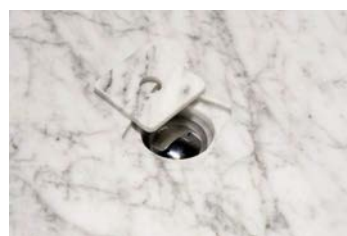

	H	P	L	art.
Marmo di Carrara / Stone Grey / Nero Marquinia	55	130	190	SOLIDEA190
Marmo di Carrara / Stone Grey / Nero Marquinia	55	130	210	SOLIDEA210

Vasca da bagno ovale in pietra, completa di piletta con sistema di scarico a pressione click-clack.

N.B. Per l'ispezione si consiglia di realizzare un pozzetto esterno (vedere schede tecniche).

Art. SOLIDEA190

Peso vasca: 900 kg.

Capacità: 550 L.

Art. SOLIDEA210

Peso vasca: 950 kg.

Capacità: 620 L.

*Oval stone bathtub complete with drain and pressure plug.*

*P.S. We advise an exterior inspection window (see technical drawings).*

*Art. SOLIDEA190*

*Weight: 900 kg.*

*Capacity: 550 L.*

*Art. SOLIDEA210*

*Weight: 950 kg.*

*Capacity: 620 L.*

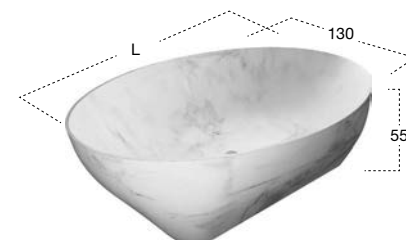

# BAÌA

\_2004

design  
Carlo  
Colombo





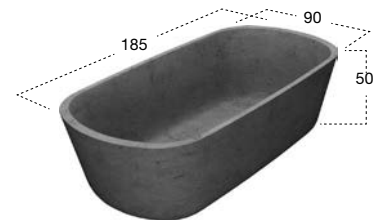

	H	P	L	art.
Pietra Luna / Stone Grey	50	90	185	BAiA

Vasca da bagno ovale in pietra, completa di piletta con sistema di scarico a pressione click-clack.

N.B. Per l'ispezione si consiglia di realizzare un pozzetto esterno (vedere schede tecniche).

Peso vasca: 800 kg.

Capacità: 400 L.

*Oval stone bathtub complete with drain and pressure plug.*

*P.S. We advise an exterior inspection window (see technical drawings).*

*Weight: 800 kg.*

*Capacity: 400 L.*

# VASCABARCA/ BARCAVASCA

\_2007

design  
Anne e Patrick  
Poirier

Per compiere un viaggio ci vuole un mezzo ma il viaggio si può compiere anche stando fermi, rilassandosi e spostandosi solo con la fantasia, esplorando con la mente nuovi territori, immergendosi nella storia e nella cultura di un paese. Una limited edition, un gesto scultoreo che prende forma e diventa oggetto, un blocco di pietra Stone Grey scavato e modellato per dare forma a uno scafo affusolato. Vascabarca/ barcavasca è una vasca dall'immagine simbolica ed evocativa, è un blocco massiccio del peso di 1600 kg con un ampio bordo a prua che permette di appoggiare accessori e oggetti. La fisicità e il peso della pietra naturale ribaltano il significato dell'oggetto, chiamato a un dialogo con l'acqua opposto rispetto alle normali convenzioni. La barca che dovrebbe galleggiare e non imbarcare acqua finisce di fatto per ospitarla, insieme con il suo equipaggio, che potrà goderne gli effetti rilassanti e rigeneranti. Perfetta per l'esterno è disponibile in dieci esemplari numerati e firmati dagli artisti.

*To make a journey you need a means or the journey can be made at a standstill, relaxing and moving only with your fantasy exploring new territories with your mind immersed in history and culture of a country.*

*A limited edition, a sculptural gesture that takes shape and become an object, a block of Stone Grey carved and molded to give shape to a streamlined hull. Vascabarca / barcavasca is symbolic and evocative, a solid block of stone weighing 600 kg with a wide border in the bow to support accessories and objects. Perfect also for outdoors, ten pieces available numbered and signed by the artist.*



EDIZIONE LIMITATA / LIMITED EDITION

	H	P	L	art.
Stone Grey	56	140	260	VASCABARCA/BARCAVASCA

Vasca da bagno completa di piletta con sistema di scarico a pressione click-clack.  
 N.B. Per l'ispezione, si consiglia di realizzare un pozzetto esterno (vedere schede tecniche).  
 Peso vasca: 1.600 kg.  
 Capacità: 400 L.

Di quest'opera saranno realizzati 10 esemplari in pietra, firmati e numerati in numeri romani dagli artisti; il committente potrà, se vorrà, personalizzare la propria vascabarca con un nome a sua scelta che sarà inciso a poppa.

*Stone bathtub complete with drain and pressure plug.  
 P.S. We advise an exterior inspection window (see technical drawings).  
 Weight: 1.600 kg.  
 Capacity: 400 L.*

*Of this masterpiece only 10 pieces will be made out of stone, signed and numbered with roman numbers from the artists; the buyer can choose, if wishes, to personalize their own vascabarca with a name which can be carved at stern.*

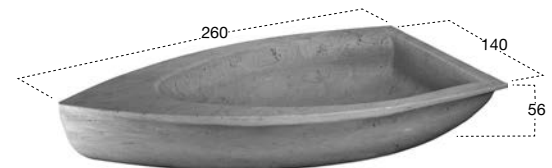



COMPLEMENTI E ACCESSORI  
*FURNISHINGS AND ACCESSORIES*

ICE  
\_2005

design  
Studio Carlesi Design

vetro extrachiario con schienale verniciato strada lucido  
*extra-clear glass with back panel lacquered glossy strada*



vetro extrachiaro con schienale verniciato opaco grigio piombo e matita  
extra-clear glass with back panel lacquered matt grey lead and matita



ICE

vetro bronzo con schienale verniciato ovatta opaco  
bronze glass with back panel lacquered matt ovatta





vetro fumé con schienale verniciato matita gofrato  
fumed glass with back panel lacquered embossed matita



vetro fumé con schienale verniciato cipria lucido  
*fumé glass with back panel lacquered glossy cipria*



vetro fumé con schienale verniciato creta opaco  
 fumé glass with back panel lacquered matt creta



Art. ICE4 / 5 / 6

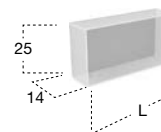

H	P	L	art.
25	14	27	ICE4
25	14	45	ICE5
25	14	72	ICE6

H	P	L	art.
50	14	27	ICE7
75	14	27	ICE8
100	14	27	ICE1
125	14	27	ICE2
150	14	27	ICE3

Pensili e colonne a giorno in vetro extrachiaro, vetro bronzo o fumé a 1, 2, 3, 4, 5 e 6 vani con schienale verniciato come da nostra cartella colori laccati.

Open wall cabinets in extra-clear glass, bronze or fume glass with 1, 2, 3, 4, 5 and 6 compartments and back panel lacquered as per our colour chart.

Art. ICE7

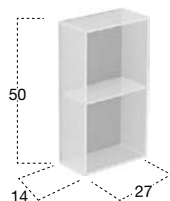

Art. ICE8

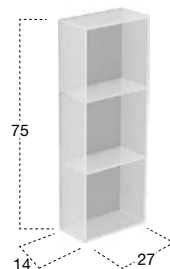

Art. ICE1

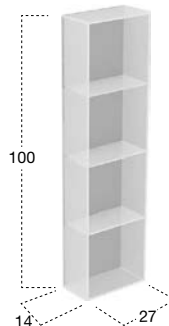

Art. ICE2

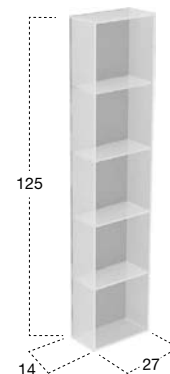

Art. ICE3

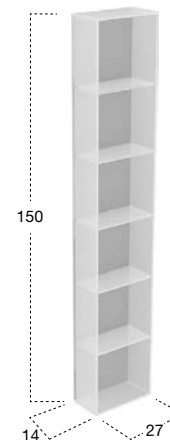

COMPLEMENTI E ACCESSORI  
 FURNISHINGS - ACCESSORIES



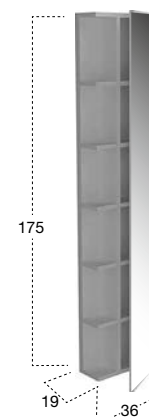
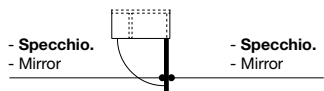

COMPLEMENTI E ACCESSORI  
FURNISHINGS - ACCESSORIES

H	P	L	art.
175	19	36	GIANO

Colonna dx o sx con anta a specchio bifacciale, 5 ripiani e un divisorio.

Right or left high cabinet with double faced mirror door, 5 internal shelves and 1 divider.



ACCESSORI  
*ACCESSORIES*

# OMBRA

\_2015

design  
Arkimera

Modello e design registrato, brevetto depositato  
*Registered model and design, patent filed*

Gioca sul rapporto tra pieni e vuoti mettendo in luce l'importanza dell'assenza, sottolinea l'essenza del segno conferendogli la terza dimensione, si esprime attraverso un perimetro che si fa volume, nasce dalla forza dell'ombra disegnata sulla parete che "sfonda" la superficie, diventando utile ed elegante contenitore: OMBRA è uno spazio accessorio ottenuto grazie all'incasso di un profilo in alluminio verniciato che permette di creare un vuoto utilizzabile per il posizionamento di tutti gli oggetti e accessori che possono trovare posto nell'ambiente bagno.

Una piccola nicchia funzionale e attrezzabile che può anche essere illuminata, un piccolo palcoscenico domestico sul quale vanno in scena i riti quotidiani legati al benessere quotidiano. Per far questo, gli accessori in tondino metallico verniciato alle polveri e i vassoi in Flumood, trovano posto all'interno dello spazio, personalizzandone l'utilizzo in base alle proprie esigenze e permettendo di trasformarlo rapidamente. Il vano può assumere lo stesso colore della parete per rivelarsi solo da vicino o al contrario differenziarsi cromaticamente dalla superficie, per sottolinearne in modo più incisivo la profondità. Ombra si configura soprattutto come valido aiuto del progettista nella risoluzione architettonica del contenimento degli oggetti. Il sistema ha infatti una vocazione sartoriale: oltre alle misure standard sarà possibile averlo della lunghezza desiderata dal cliente. Disponibile nelle versioni bianca o nera.





*A play on the relationship between solid and null, highlighting the importance of the absence is expressed through a perimeter that makes volume, stemming from the strength of the shadow drawn on the wall that breaks through the surface becoming a useful and elegant container: OMBRA is an accessory obtained from a collection of a painted aluminum profiles that allows you to create an empty space used for the positioning of all objects and accessories that can fit in the bathroom.*

*A small functional niche that can also be illuminated, a small domestic stage for everyday rituals. Lacquered metal rods and the trays in Flumood are placed inside the space to customize your needs. The compartment can have the same color of the wall or otherwise to emphasize depth for a more dramatic effect. Ombra is especially configured as a valid aid to the designer in the architectural resolution of accessorizing. The system has in fact a tailor vocation: in addition to the standard measures it will be possible in custom lengths. Available in black or white.*



su richiesta è possibile realizzare la mensola nella lunghezza desiderata.  
upon request it is possible to make the shelf in a customized length.









OMBRA

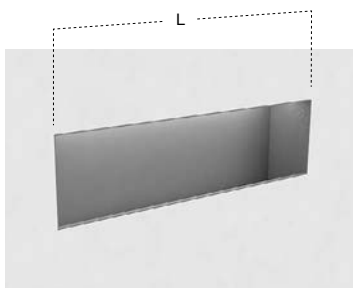
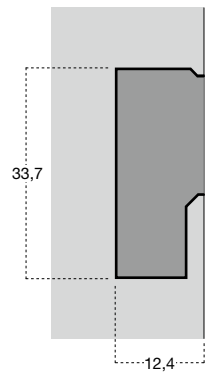

H	P	L	art.	art.
33,7	12,4	da / from 36 a / to 216	OMBRA	OMBRAL Con illuminazione a led / With led lighting

Mensola da incasso a parete con struttura in alluminio bianca o nera, con o senza illuminazione a led.

*Recessed wall shelf with white or black aluminum frame, with or without LED lighting.*

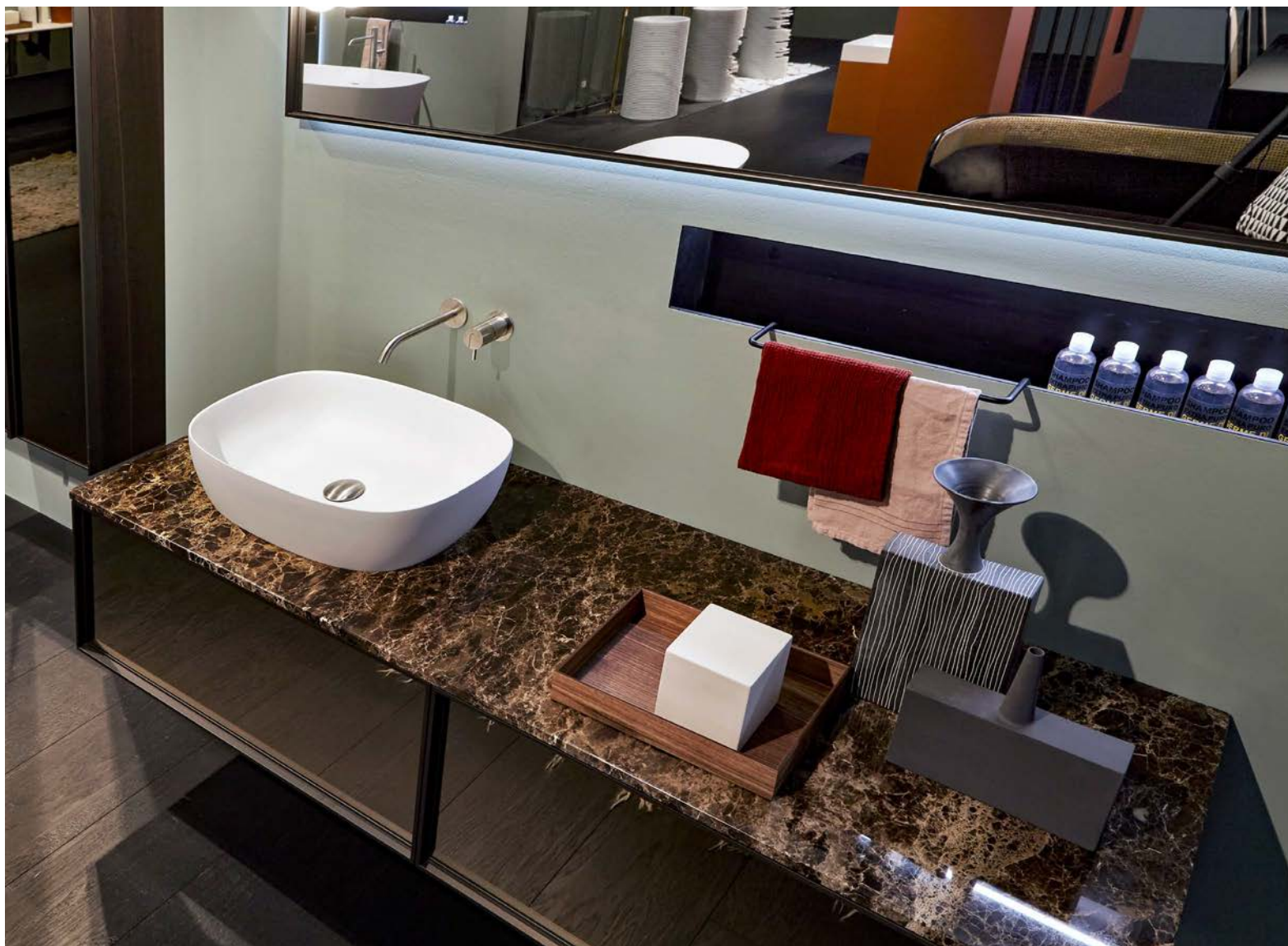

H	P	L	art.
10	12,8	27	OMBRAPS27
		36	OMBRAPS36
		54	OMBRAPS54

Porta salviette in alluminio bianco o nero per mensola Art. OMBRA e Art. OMBRAL.

*White or black aluminum towel holder for Art. OMBRA and Art. OMBRAL shelf.*

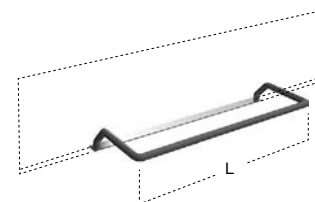

# TABULA

\_2016

design  
Mario  
Ferrarini

Modello e design registrato, brevetto depositato  
*Registered model and design, patent filed*



“In principio era Caos soltanto”, scrive Esiodo, poi finalmente è arrivata TABULA, una collezione di pianetti/vassoio in Flumood per organizzare gli oggetti di uso quotidiano in bagno e in qualunque altro ambiente. Componibile, trasportabile, multiuso, resistente agli urti, TABULA si integra e crea ordine, incorniciando e valorizzando gli oggetti.

*“In the beginning there was only Chaos”, Esiodo wrote, than TABULA finally arrived, a collection of trays made of Flumood to organize objects of everyday use in the bathroom or any other environment. Modular, portable, multipurpose, shock resistant, TABULA integrates and creates order, framing and enhancing objects.*



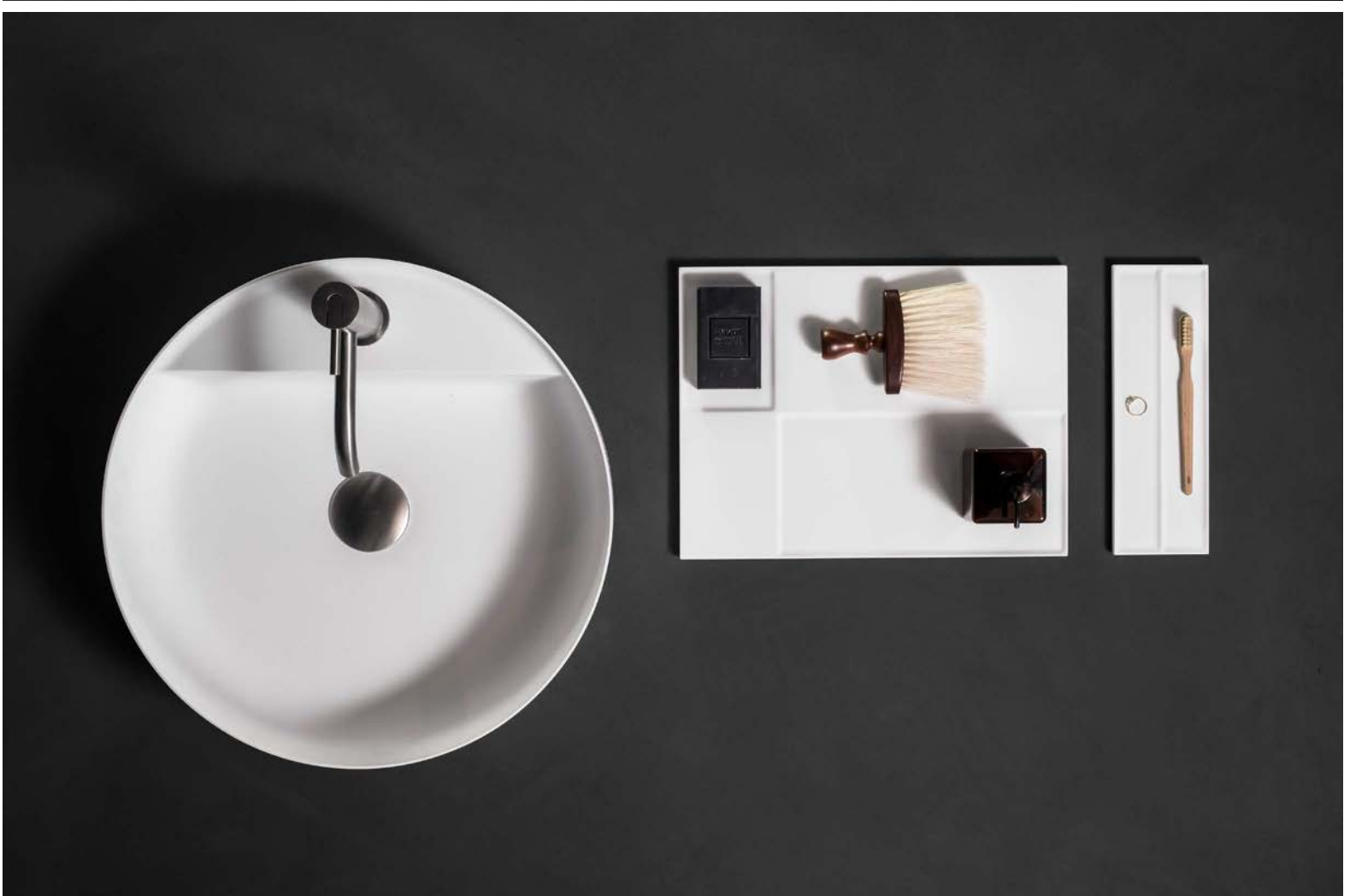



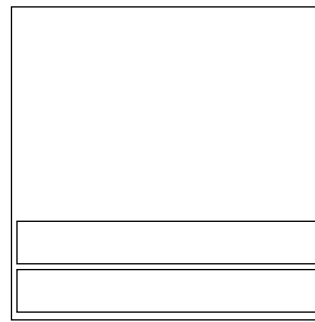

art.TAB1127 cm 27x27x1,2

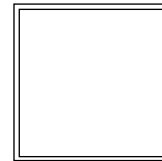

art.TAB213 cm 13,5x13,5x1,2

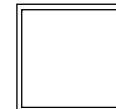

art.TAB209 cm 9x9x1,2

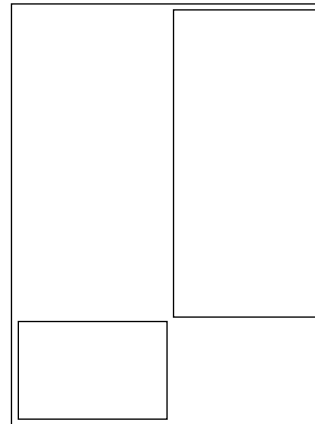

art.TAB3136 cm 27x36x1,2

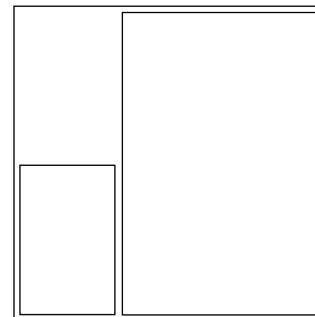

art.TAB4127 cm 27x27x1,2

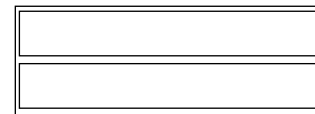

art.TAB5109 cm 27x9x1,2

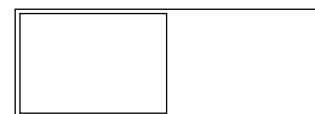

art.TAB6109 cm 27x9x1,2

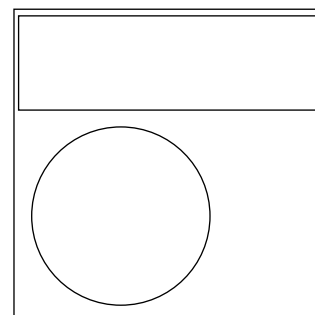

art.TAB7127 cm 27x27x1,2





# SESAMO

\_2012

design  
Arkimera

Modello e design registrato, brevetto depositato  
*Registered model and design, patent filed*

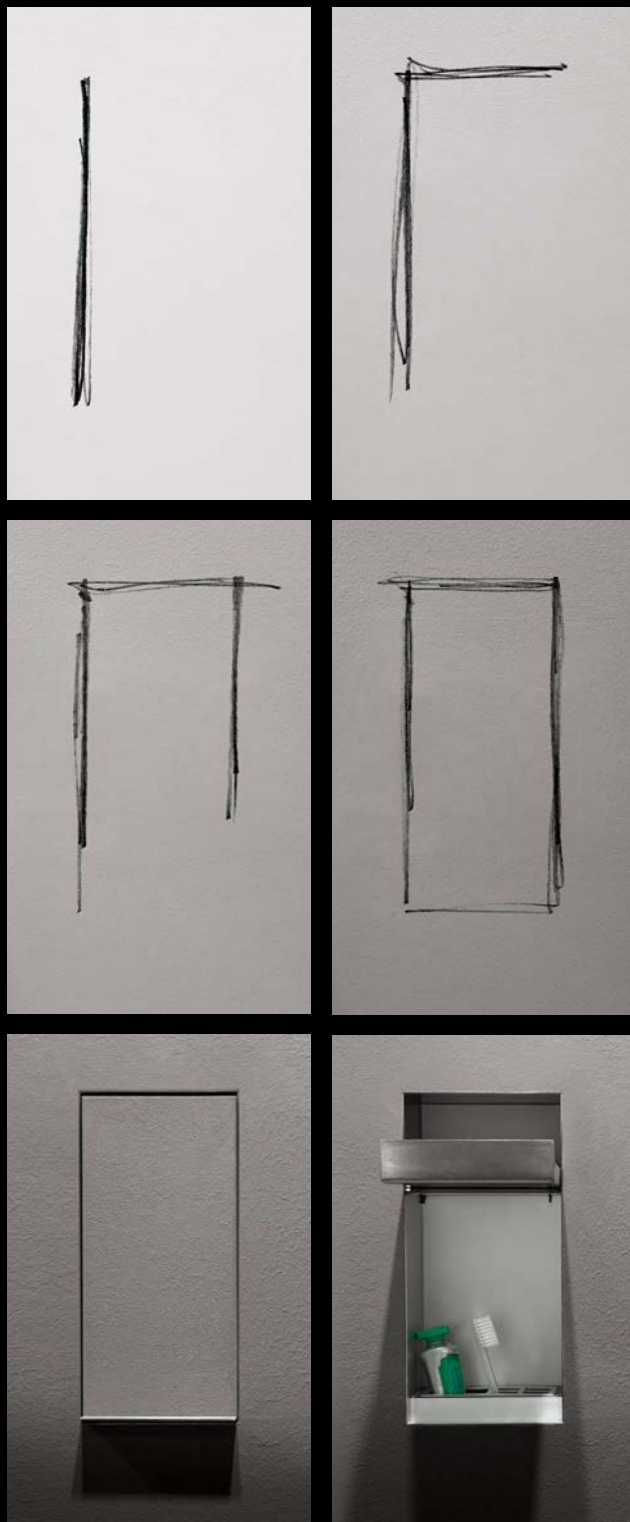

Sesamo è una collezione innovativa che supera il concetto di accessori per il bagno in modo radicale, li mantiene invisibili per poi renderli disponibili al momento dell'utilizzo. Le nicchie sono realizzate in acciaio inox e possono essere rivestite con lo stesso materiale della parete. Nessun limite per il tipo di finitura, massima igiene e funzionalità.

*Sesamo is an innovative collection that dramatically goes beyond the concept of bathroom accessories, making them invisible yet available only when necessary. The niches are made of stainless steel and can be coated with the same wall material. No limits to the type of finish, maximum hygiene and functionality.*

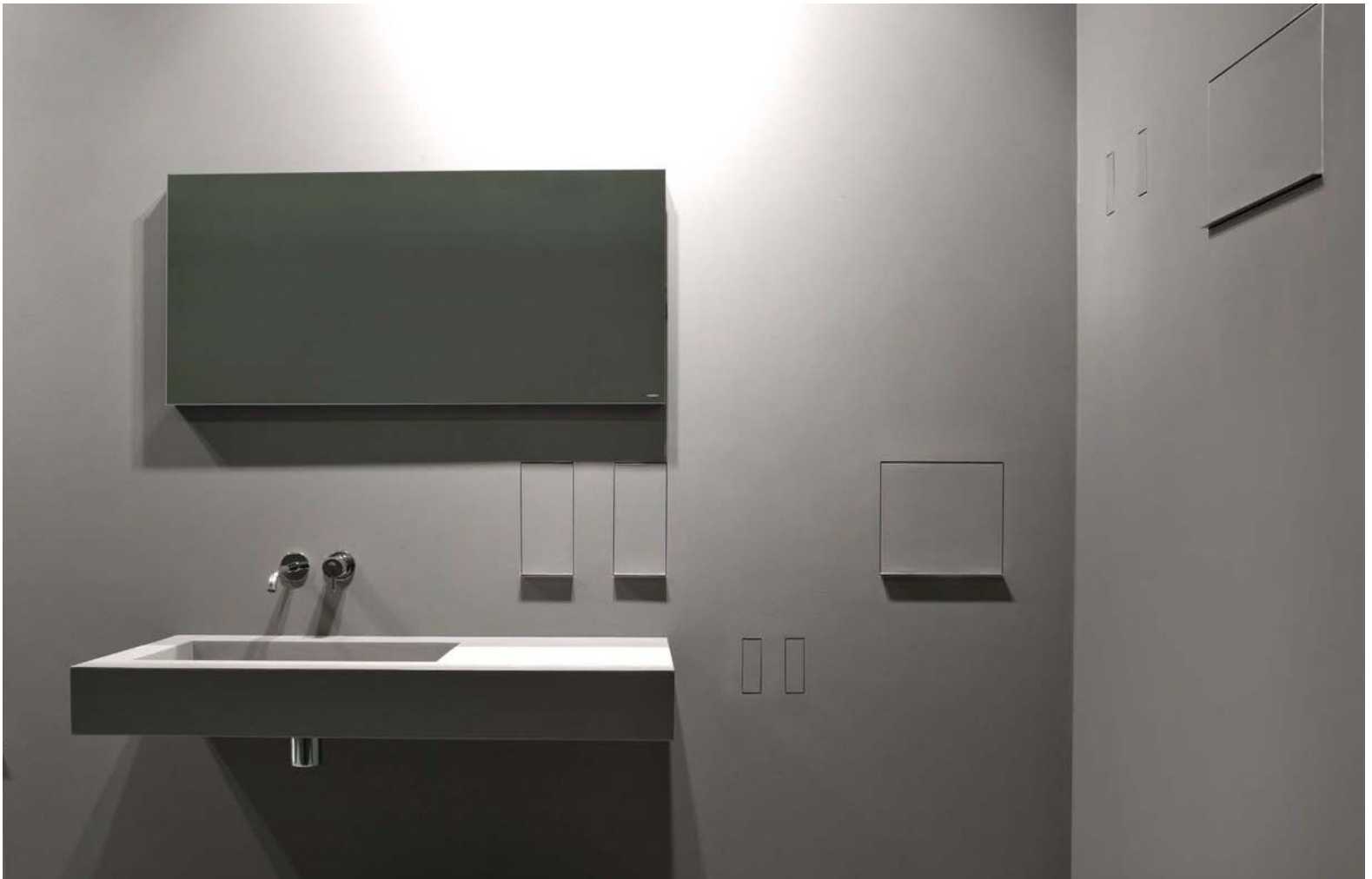

SESAMO







Spesso l'innovazione e la genialità si nascondono nelle cose semplici: Georges de Mestral inventò il velcro nel 1941 osservando, al ritorno da una gita in campagna, gli uncini sul calice dei fiori di bardana che erano rimasti attaccati alla sua giacca, Ruben Rausing utilizzando un sistema di rivestimento plastico della carta riuscì a renderla assolutamente impenetrabile all'aria, ponendo le basi dei contenitori per la conservazione degli alimenti più utilizzati e di un'azienda come la Tetra Pack. Sesamo nel suo piccolo è frutto di un'intuizione altrettanto geniale: osservando le cassette del wc incassate, allo studio Arkimera si è pensato di incassare e rendere invisibili gli accessori, antoniolupi ci ha creduto et voilà è nato Sesamo.

*Often innovation and cleverness lie behind simple things: Georges de Mestral invented Velcro in 1941 while observing, upon his return from a trip to the countryside, the seeds of the burdock plant that had attached themselves to his clothes, Ruben Rausing using a type of plastic coated paper was able to make it absolutely impenetrable to air, laying the foundations of containers for food storage of a company like Tetra Pack. Sesamo is the result of an equally brilliant intuition: observing the encased toilet cisterns, the Arkimera studio decided to encase and hide accessories of which antoniolupi supported the idea and voilà, Sesamo was born.*



- 1 SESAM05 Porta carta igienica con scorta / Toilet paper holder with spare
- 2 SESAM04 Porta carta igienica / Toilet paper holder - P 10,4 cm
- SESAM041 Porta carta igienica / Toilet paper holder - P 15 cm
- 3 SESAM06 Porta scopino / Toilet brush holder
- 4 SESAM07 Cestino rifiuti / Waste basket
- 5 SESAM02 Porta dispenser/spazzolini / Soap dispenser
- 6 SESAM03 Porta dispenser doppio / Double soap dispenser
- 7 SESAM01 Appendi abiti / Wall hook

SESAMO

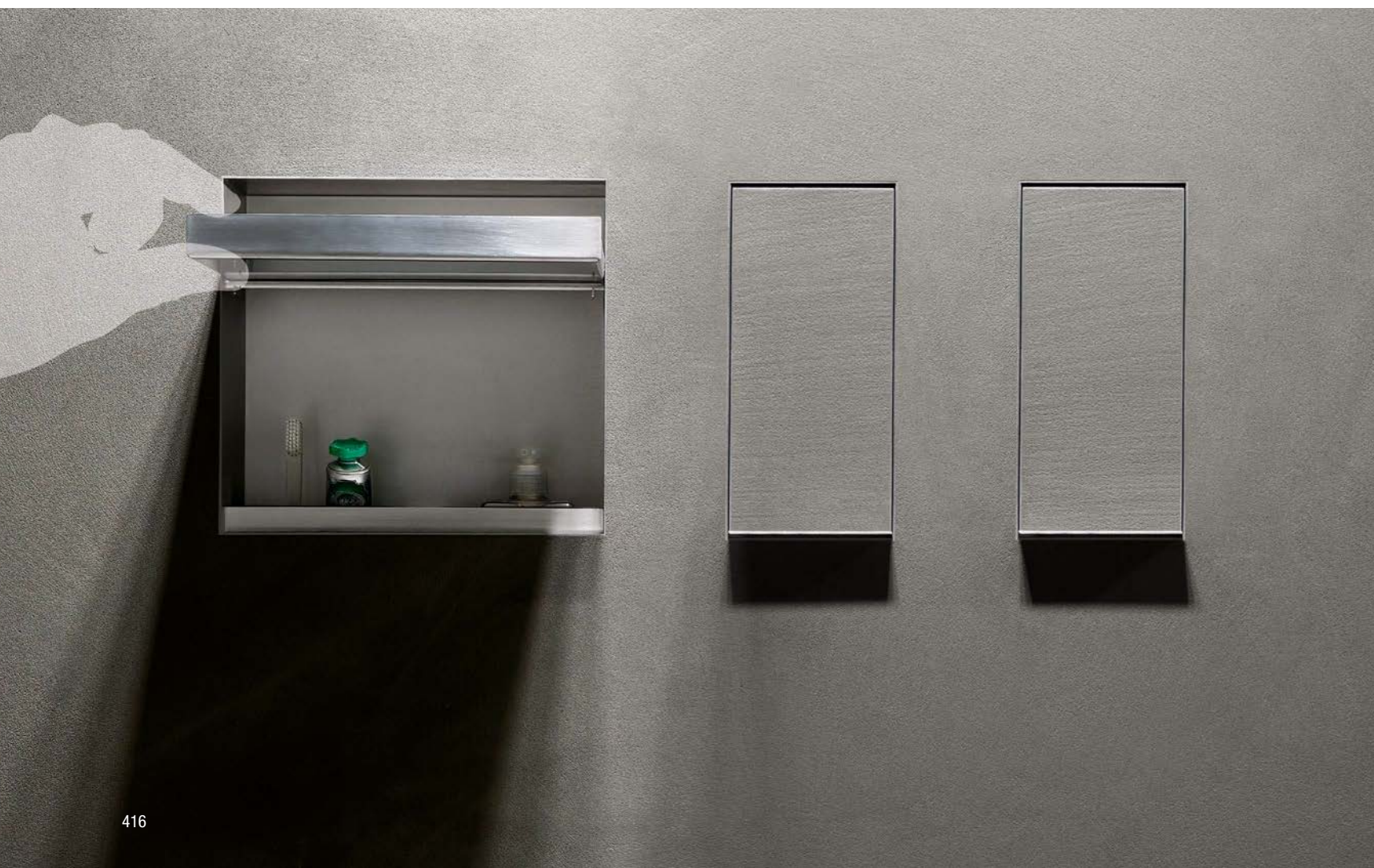
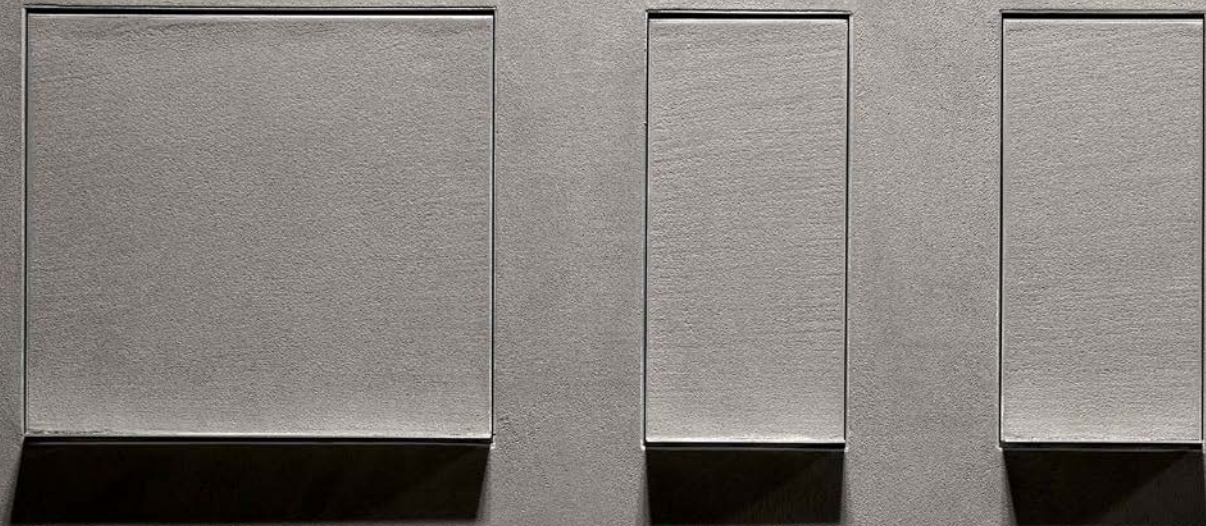

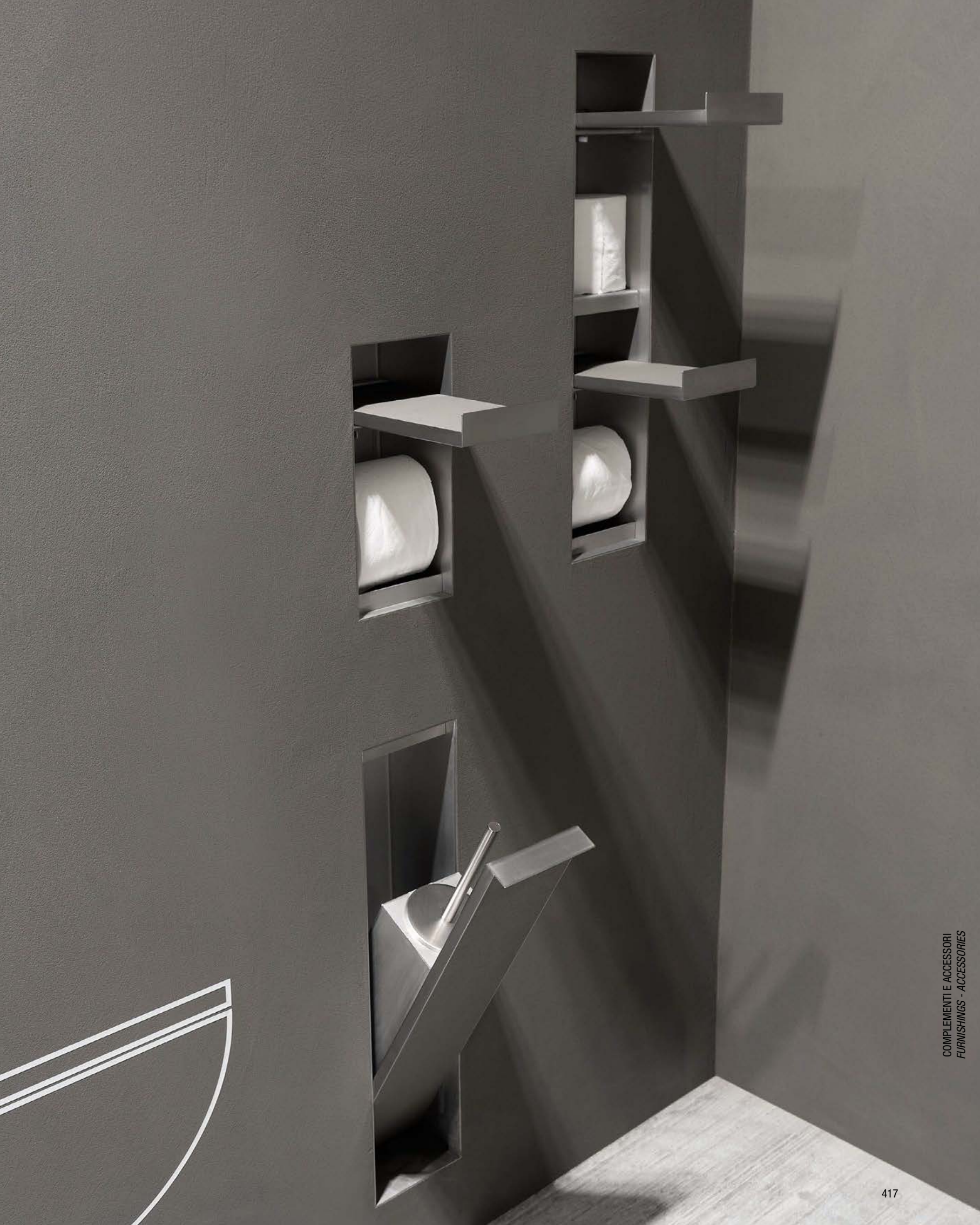



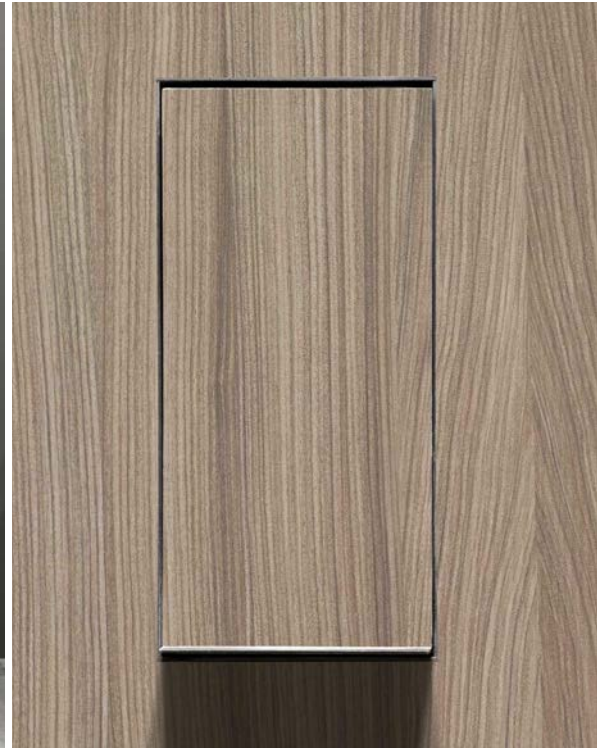

Sentitevi liberi di esprimere il vostro stile

*Feel free to express your style*

Sentitevi liberi di esprimere il vostro stile, Sesamo si inserisce perfettamente in ogni superficie, diventa pietra, legno, metallo, carta da parati... sentitevi liberi di inventare...  
*Feel free to express your style, Sesamo fits perfectly into any surface, like stone, wood, metal, wallpaper... feel free to use your imagination ...*

# SESAMO

Applicazione su cartongesso con finitura intonaco  
*Application on drywall with plaster finishing*

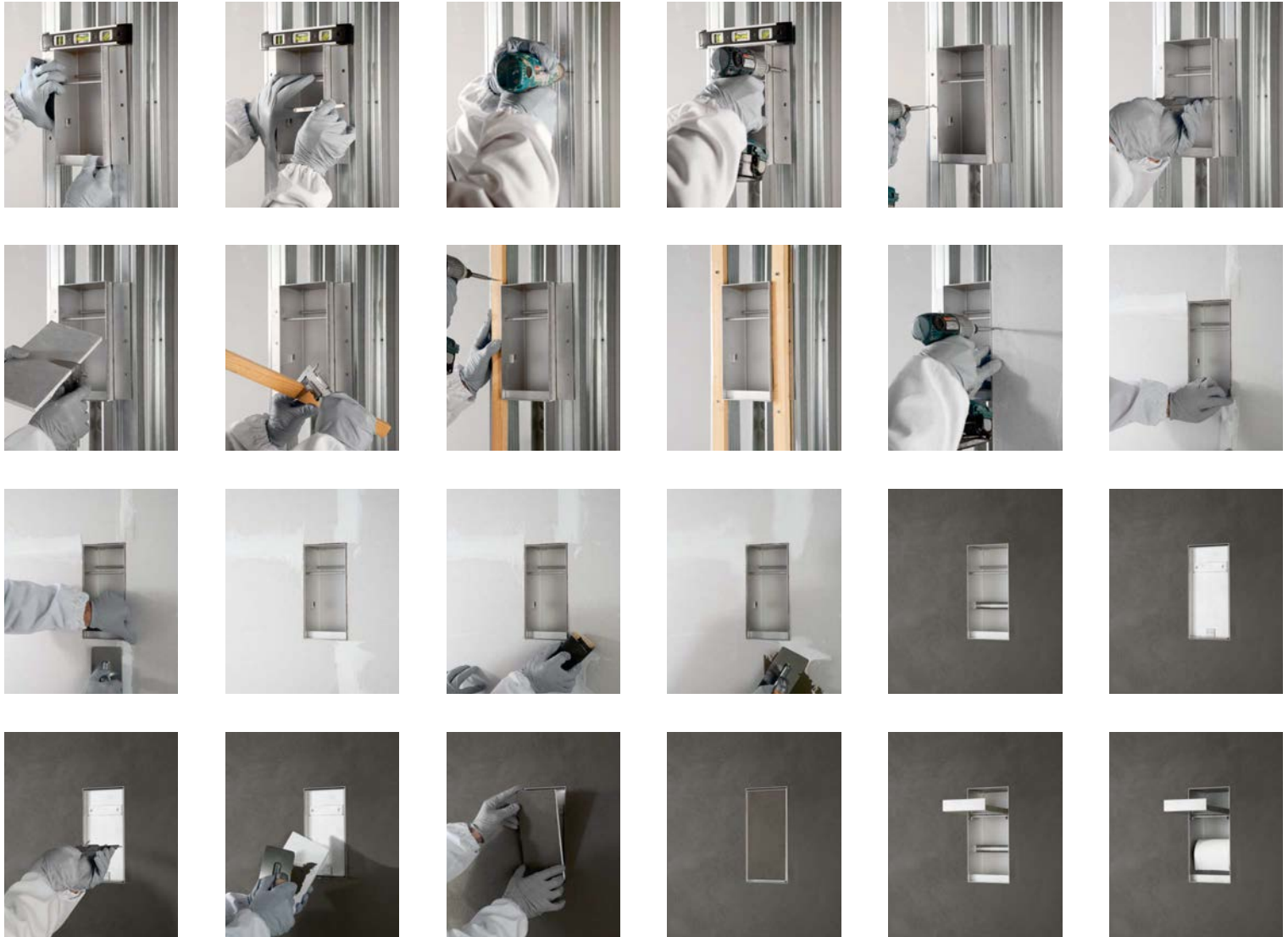

Applicazione su cartongesso con rivestimento marmo  
*Application on drywall with marble covering*

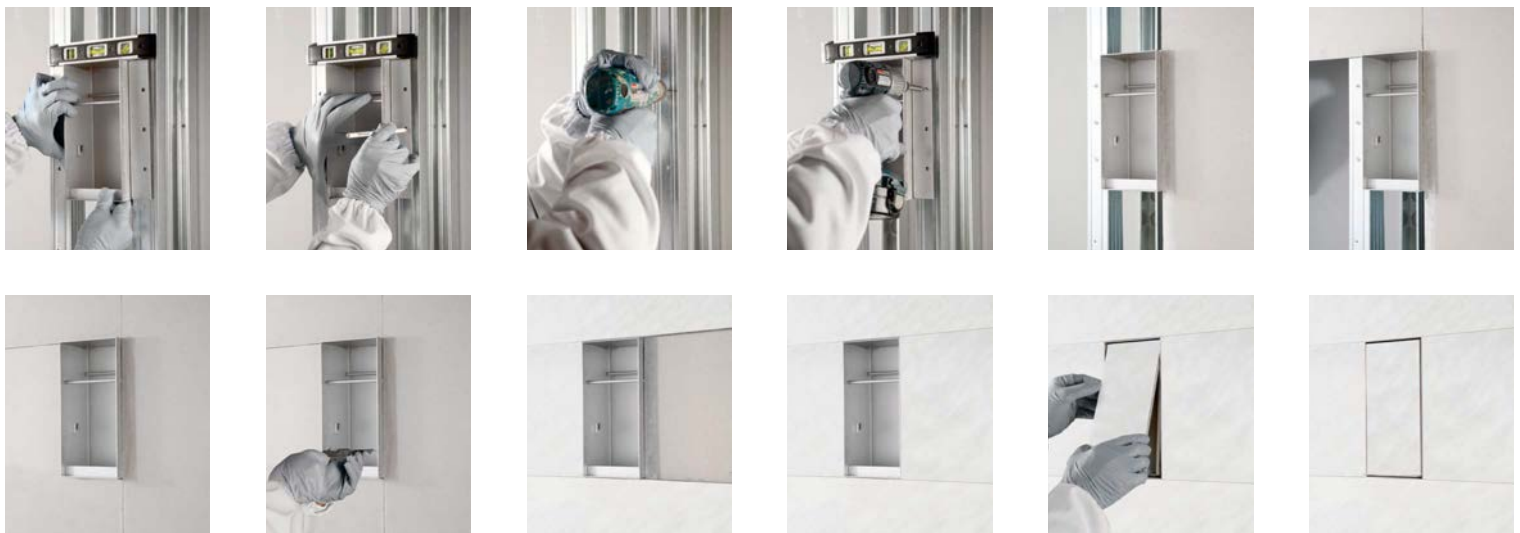

Appendi abiti da incasso a parete in acciaio inox AISI 304 finitura alluminio.

*Encased wall hook in stainless steel AISI 304 with an aluminum finish.*



H	P	L	art.
12,5	5,5	7,3	SESAM01

Porta dispenser o porta spazzolini da incasso a parete in acciaio inox AISI 304 finitura alluminio.

*Encased soap dispenser in stainless steel AISI 304 with an aluminum finish.*



H	P	L	art.
31,5	10,4	19,8	SESAM02

Porta scopino da incasso a parete in acciaio inox AISI 304 finitura alluminio.

*Encased toilet brush holder in stainless steel AISI 304 with an aluminum finish.*



H	P	L	art.
50	10,4	19,8	SESAM06

Porta carta con scorta da incasso a parete in acciaio inox AISI 304 finitura alluminio.

*Encased toilet paper holder and spare in stainless steel AISI 304 with an aluminum finish.*



H	P	L	art.
50	10,4	19,8	SESAM05

Porta carta da incasso a parete in acciaio inox AISI 304 finitura alluminio.

N.B. Lo spazio utile interno in profondità è di 8,7 cm per Art. SESAM04 e di 13,5 cm per Art. SESAM041.

*Encased toilet paper holder in stainless steel AISI 304 with an aluminum finish.*

*P.S. The internal useful space is 8,7 cm for Art. SESAM04 and is 13,5 cm for Art. SESAM041.*



H	P	L	art.
25	10,4	19,8	SESAM04
25	15	19,8	SESAM041

Porta dispenser o porta spazzolini doppio da incasso a parete in acciaio inox AISI 304 finitura alluminio.

*Encased double soap dispenser in stainless steel AISI 304 with an aluminum finish.*



H	P	L	art.
31,5	10,4	35	SESAM03

Cestino rifiuti da incasso a parete in acciaio inox AISI 304 finitura alluminio.

*Encased waste basket in stainless steel AISI 304 with an aluminum finish.*



H	P	L	art.
50	10,4	19,8	SESAM07

# RETTA

\_2011

design  
Nevio  
Tellatin







Porta salviette in alluminio verniciato bianco, nero opaco o colorato gofrato come da nostra cartella colori laccati.

*Towel holder in aluminium lacquered matt white, black or embossed as per our colour chart.*

H	P	L	art.
8	5	54	RETTA454
		72	RETTA472
		90	RETTA490
		108	RETTA4108

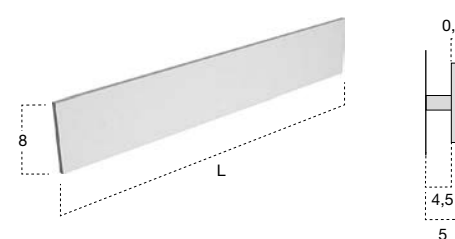

Porta salviette in alluminio verniciato bianco, nero opaco o colorato gofrato come da nostra cartella colori laccati.

*Towel holder in aluminium lacquered matt white, black or embossed as per our colour chart.*

H	P	L	art.
8	13	54	RETTA1254
		72	RETTA1272
		90	RETTA1290
		108	RETTA12108

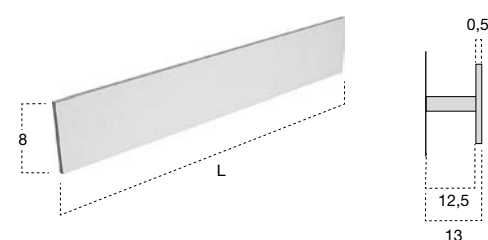

# TAPE

\_2003

design  
Carlo  
Colombo

Tutta la serie TAPE é realizzata in acciaio inox satinato AISI 304.  
*The TAPE series is produced in satin stainless steel AISI 304.*





TAPE





TAPE





COMPLEMENTI E ACCESSORI  
FURNISHINGS - ACCESSORIES

**TAPE 72**



**TAPE 54**



**TAPE 45**



**TAPE 36**



**TAPE 27**

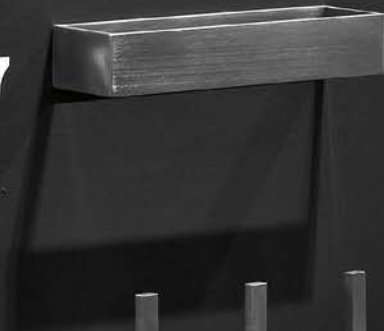

**TAPE 113**



**TAPE** ...per esempio...  
...for example...

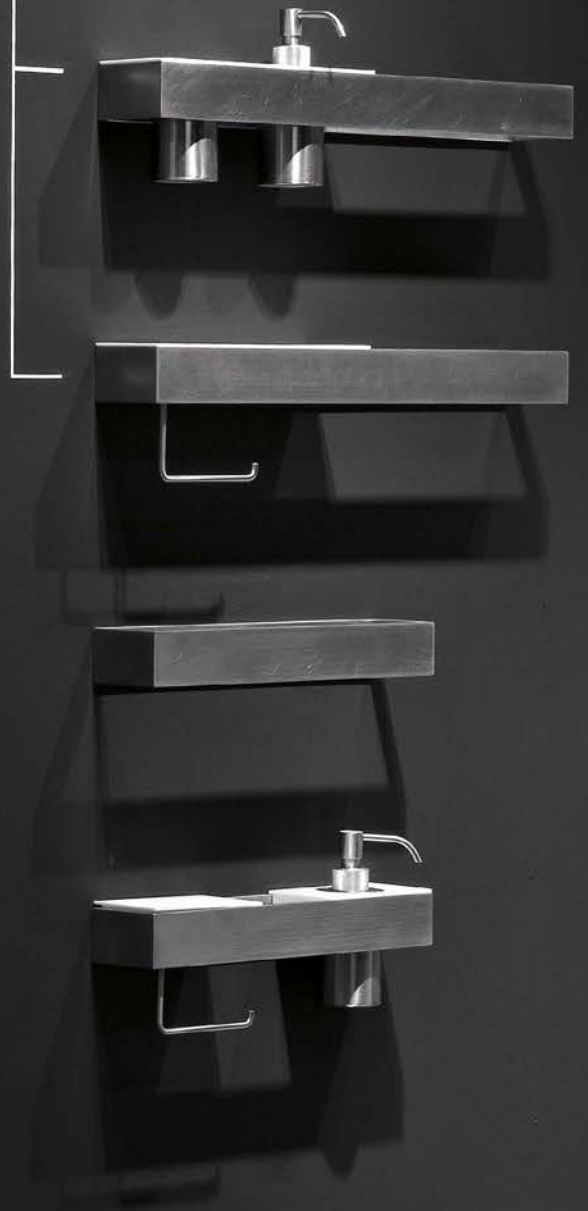





# TAPE



Appendi abiti singolo a parete in acciaio inox satinato AISI 304.

*Satin stainless steel AISI 304 clothes hook.*

H	P	L	art.
6	8	8	TAPE106



Appendi abiti doppio a parete in acciaio inox satinato AISI 304.

*Double satin stainless steel AISI 304 clothes hook.*

H	P	L	art.
6	8	16	TAPE107



Dispenser sapone liquido da appoggio o da incasso per pianetti Corian in acciaio inox satinato AISI 304.

*Freestanding or encased soap dispenser in satin stainless steel AISI 304 for Corian surfaces.*

H	P	Ø	art.
16	9,5	6,5	TAPE101



Pianetto in Corian liscio.

*Corian surface.*

H	P	L	art.
1,2	8	13,5	TAPE1



Bicchiere da appoggio o da incasso per pianetti Corian in acciaio inox satinato AISI 304.

*Freestanding or encased cup in satin stainless steel AISI 304 for Corian surfaces.*

H	P	Ø	art.
10,5	6,5	6,5	TAPE102



Porta scopino da appoggio in resina bianca e manico in acciaio inox satinato AISI 304.

*Toilet brush and white resin holder with a satin stainless steel AISI 304 handle.*

H	P	Ø	art.
44	8	8	TAPE113

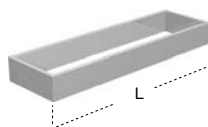

Porta salviette in acciaio inox satinato AISI 304.

*Satin stainless steel AISI 304 towel rack.*

H	P	L	art.
5	8	27	TAPE27
		36	TAPE36
		45	TAPE45
		54	TAPE54
		72	TAPE72



Pianetto in Corian liscio dx o sx reversibile, con portarotolo in acciaio inox satinato AISI 304.

*Corian surface right or left with satin stainless steel AISI 304 paper roll holder.*

H	P	L	art.
12	8	13,5	TAPE2

Porta sapone in Corian.

*Corian soap dish.*



H	P	L	art.
1,2	8	13,5	TAPE3

Porta sapone in Corian dx o sx reversibile, con portarotolo in acciaio inox satinato AISI 304.

*Corian soap dish right or left with satin stainless steel AISI 304 paper roll holder.*



H	P	L	art.
12	8	13,5	TAPE4

Pianetto in Corian con foro per bicchiere o dispenser.

*Corian surface with hole for cup or dispenser.*



H	P	L	art.
1,2	8	13,5	TAPE5

Pianetto in Corian con griglia.

*Grided Corian surface.*



H	P	L	art.
1,2	8	13,5	TAPE6

Pianetto in Corian liscio.

*Corian surface.*



H	P	L	art.
1,2	8	27	TAPE11

Pianetto in Corian con foro per bicchiere o dispenser.

*Corian surface with hole for cup or dispenser.*



H	P	L	art.
1,2	8	27	TAPE12

Pianetto in Corian con 2 fori per bicchiere o dispenser.

*Corian surface with 2 holes for cup or dispenser.*



H	P	L	art.
1,2	8	27	TAPE13

Pianetto in Corian con griglia.

*Grided Corian surface.*



H	P	L	art.
1,2	8	27	TAPE14

PLAY

\_2005

design  
AL Studio

La collezione PLAY é in acciaio inox lucido AISI 304 o in alluminio finitura zirconio, bronzo, titanio e champagne

*The PLAY Collection is in polished stainless steel AISI 304 or aluminum available in finishes zirconio, bronzo, titanio and champagne.*



ZIRCONIO



BRONZO



TITANIO



CHAMPAGNE

















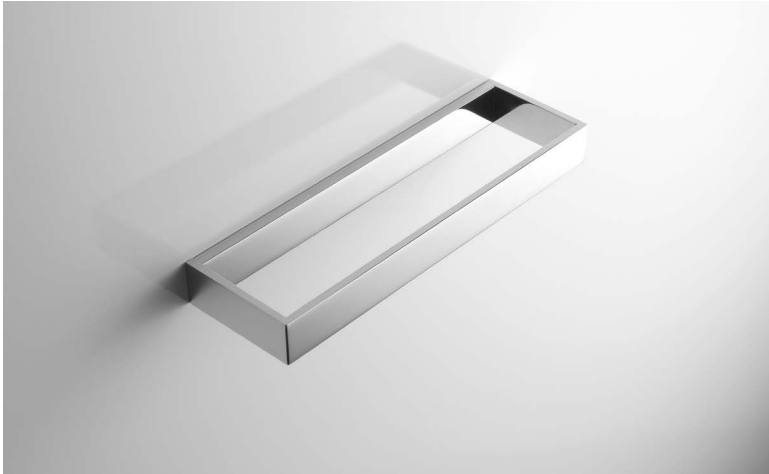

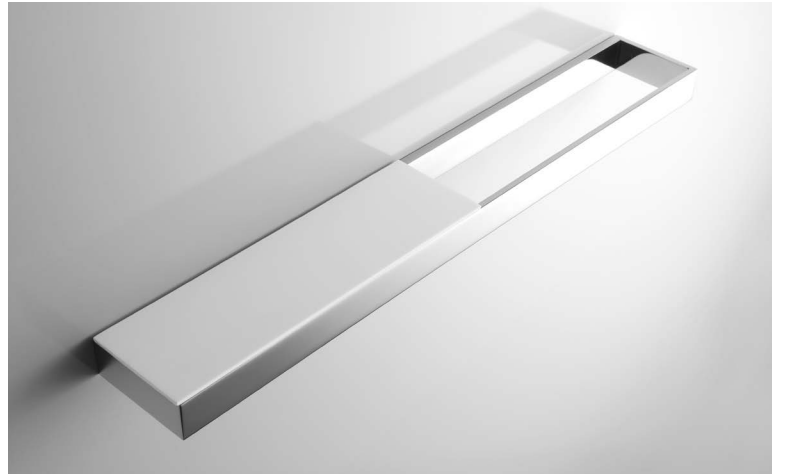
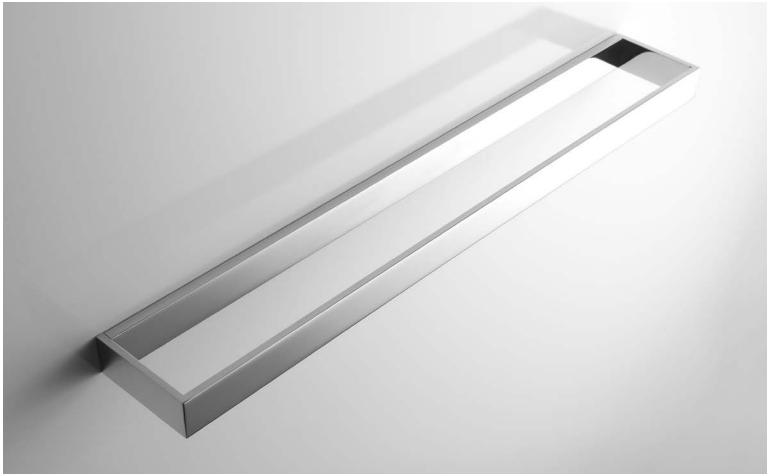

# PLAY

Appendi abiti singolo a parete in acciaio inox lucido AISI 304 o in alluminio finitura come da nostro campionario colori.

*Clothes hook in polished stainless steel AISI 304 or aluminum finish as per our color samples.*



H	P	L	art.
3	8	6	PLAY106

Appendi abiti doppio a parete in acciaio inox lucido AISI 304.

*Double polished stainless steel AISI 304 clothes hook.*



H	P	L	art.
3	8	12	PLAY107

Dispenser sapone liquido da appoggio o da incasso per pianetti Corian in acciaio inox lucido AISI 304.

*Freestanding or encased soap dispenser for Corian surfaces in polished stainless steel AISI 304.*



H	P	Ø	art.
16	9,5	6,5	PLAY101

Bicchiere da appoggio o da incasso per pianetti Corian in acciaio inox lucido AISI 304.

*Freestanding or encased cup for Corian surfaces in polished stainless steel AISI 304.*



H	P	Ø	art.
10,5	6,5	6,5	PLAY102

Porta scopino da appoggio in resina bianca e manico in acciaio inox lucido AISI 304.

*Toilet brush and white resin holder with a polished stainless steel AISI 304 handle.*



H	P	Ø	art.
44	8	8	PLAY113

Porta salviette in acciaio inox lucido AISI 304 o in alluminio finitura come da nostro campionario colori.

*Towel rack in polished stainless steel AISI 304 or aluminum finish as per our color samples.*

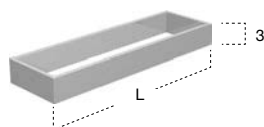

H	P	Ø	art.
3	8	27	PLAY27
		40	PLAY40
		54	PLAY54
		72	PLAY72

Pianetto in Corian liscio.

*Corian surface.*



H	P	L	art.
1,2	8	13,5	TAPE1

Pianetto in Corian liscio dx o sx reversibile, con portarotolo in acciaio inox lucido AISI 304 o in alluminio finitura come da nostro campionario colori.

*Corian surface with right or left paper roll holder in polished stainless steel AISI 304 or aluminum finish as per our color samples.*



H	P	L	art.
10	8	13,5	PLAY2

Porta sapone in Corian.

*Corian soap dish.*



H	P	L	art.
1,2	8	13,5	TAPE3

Porta sapone in Corian dx o sx reversibile, con portarotolo in acciaio inox lucido AISI 304 o in alluminio finitura come da nostro campionario colori.

*Corian soap dish with right or left paper roll holder in polished stainless steel AISI 304 or aluminum finish as per our color samples.*



H	P	L	art.
10	8	13,5	PLAY4

Pianetto in Corian con foro per bicchiere o dispenser.

*Corian surface with hole for cup or dispenser.*



H	P	L	art.
1,2	8	13,5	TAPE5

Pianetto in Corian con griglia.

*Grided Corian surface.*



H	P	L	art.
1,2	8	13,5	TAPE6

Pianetto in Corian liscio.

*Corian surface.*



H	P	L	art.
1,2	8	27	TAPE11

Pianetto in Corian con foro per bicchiere o dispenser.

*Corian surface with hole for cup or dispenser.*



H	P	L	art.
1,2	8	27	TAPE12

Pianetto in Corian con 2 fori per bicchiere o dispenser.

*Corian surface with 2 holes for cup or dispenser.*



H	P	L	art.
1,2	8	27	TAPE13

Pianetto in Corian con griglia.

*Gridded Corian surface.*



H	P	L	art.
1,2	8	27	TAPE14

Bicchieri da appoggio in resina bianca.

*White resin cup.*



H	P	Ø	art.
12	8	8	JUST1

Porta sapone da appoggio in resina bianca.

*White resin soap dish.*



H	P	L	art.
3	8	12	JUST3

Dispenser sapone liquido da appoggio in resina bianca e acciaio inox lucido AISI 304.

*White and polished stainless steel AISI 304 resin soap dispenser.*



H	P	Ø	art.
19	11	8	PLAY6

Bicchiere in resina bianca con supporto a parete in acciaio inox lucido AISI 304.

*White resin cup with polished stainless steel AISI 304 wall support.*



H	P	Ø	art.
15	11,2	8	PLAY11

Dispenser sapone liquido in resina bianca con supporto a parete in acciaio inox lucido AISI 304.

*White resin soap dispenser with polished stainless steel AISI 304 wall support.*



H	P	Ø	art.
22	14,2	8	PLAY14

Piantana porta carta, porta salviette doppio in acciaio inox lucido AISI 304 con porta scopino in resina bianca.

*Freestanding polished stainless steel AISI 304 double paper roll or towel rack with white resin toilet brush and holder.*



H	P	L	art.
60	21,5	33	PLAY136

# JUST

\_2007

design  
AL Studio

Tutta la serie JUST é realizzata in acciaio inox satinato AISI 304.  
*The JUST series is produced in satin stainless steel AISI 304.*

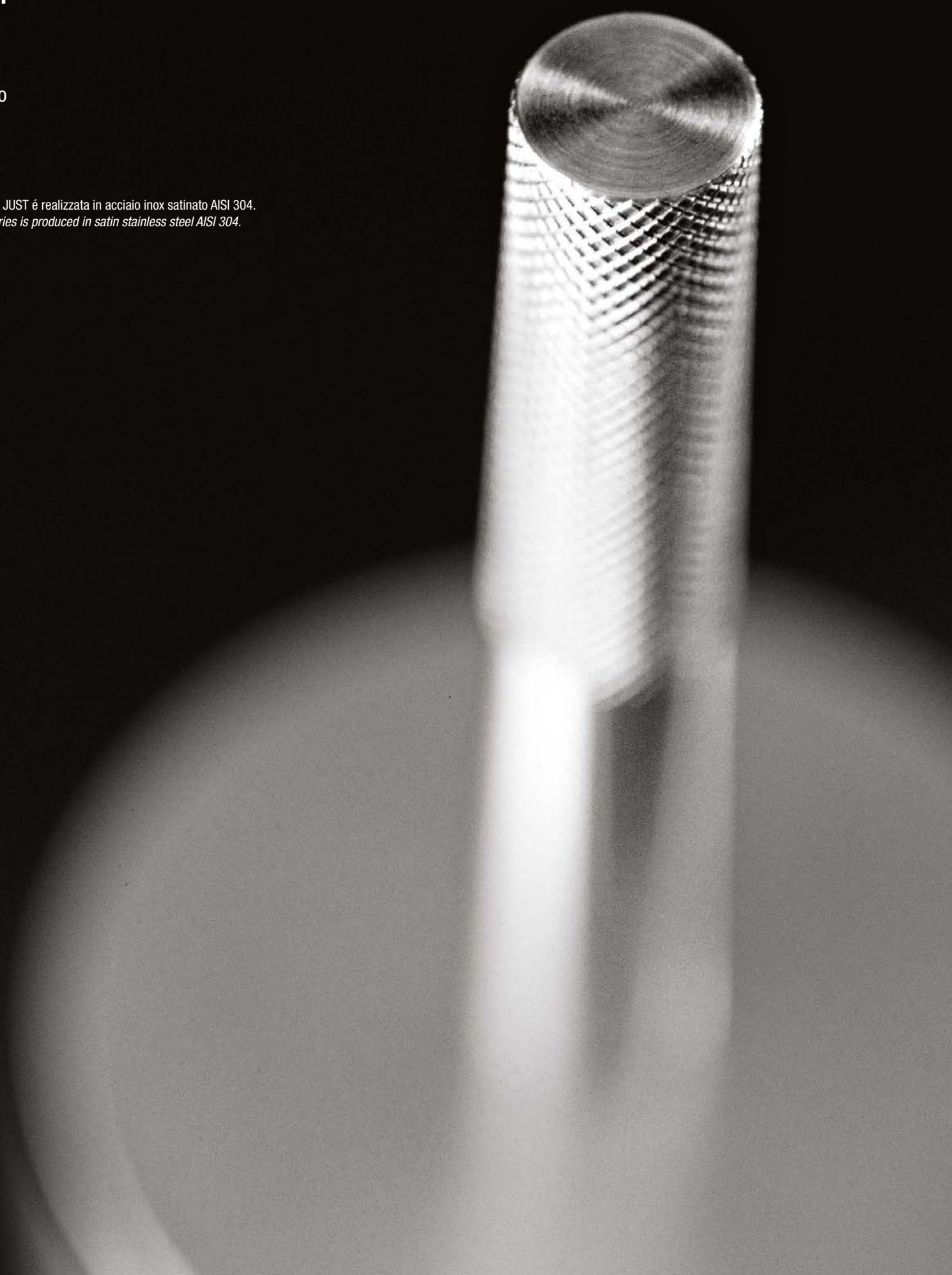



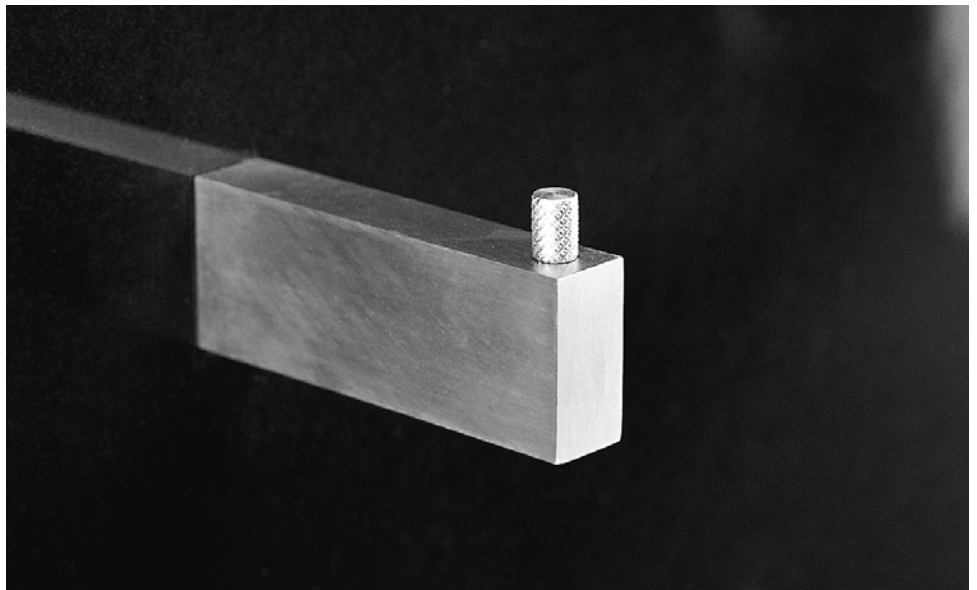
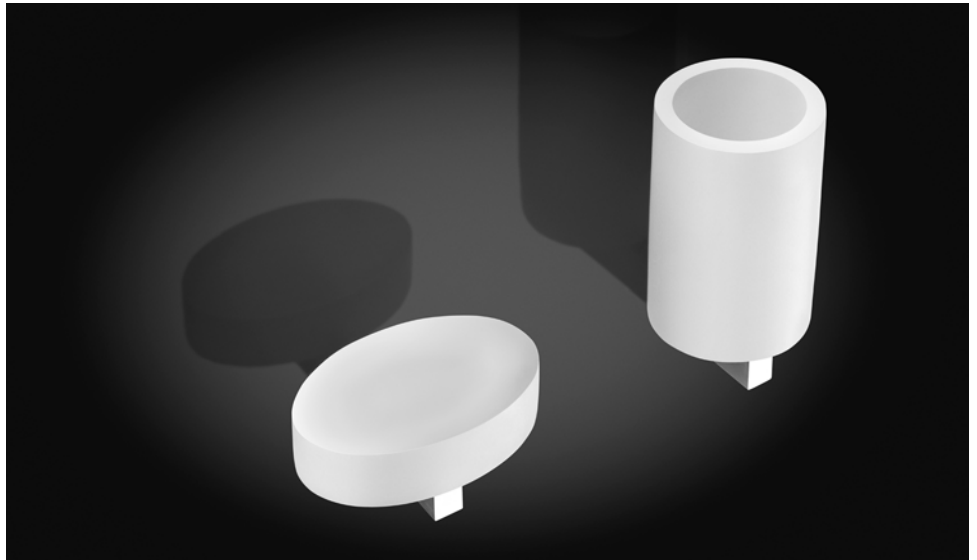



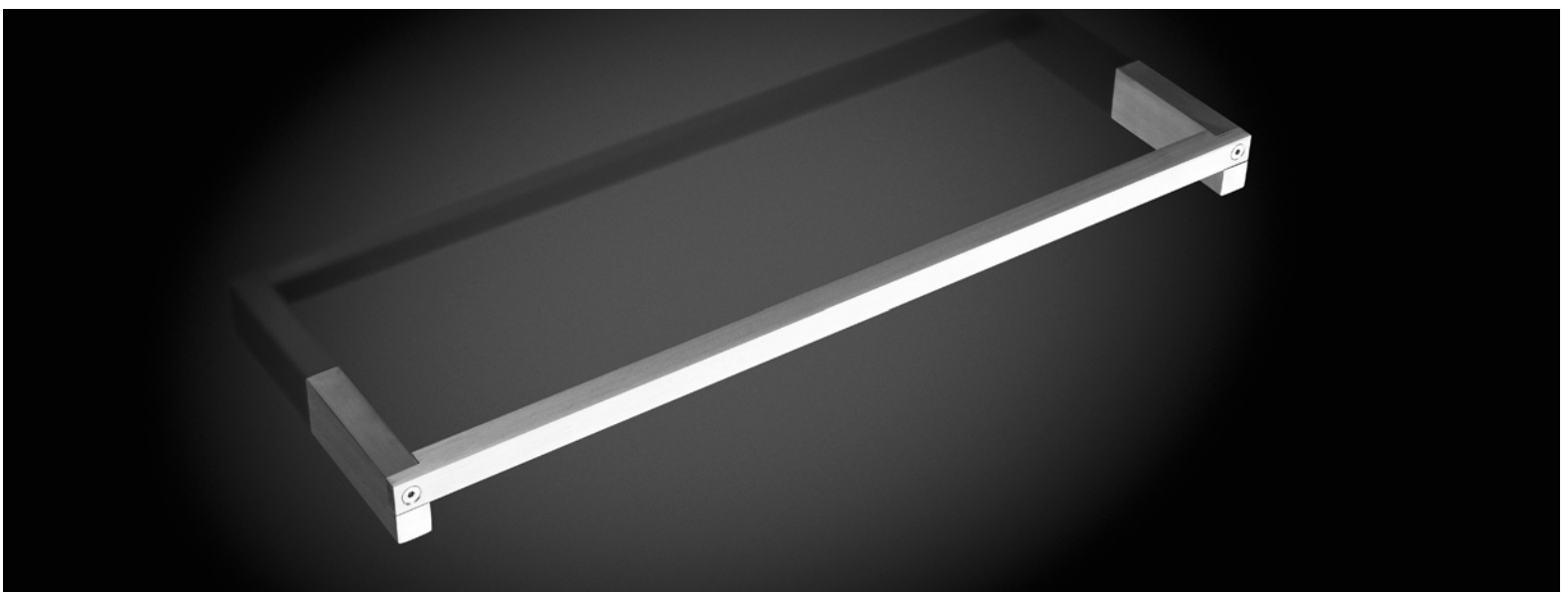
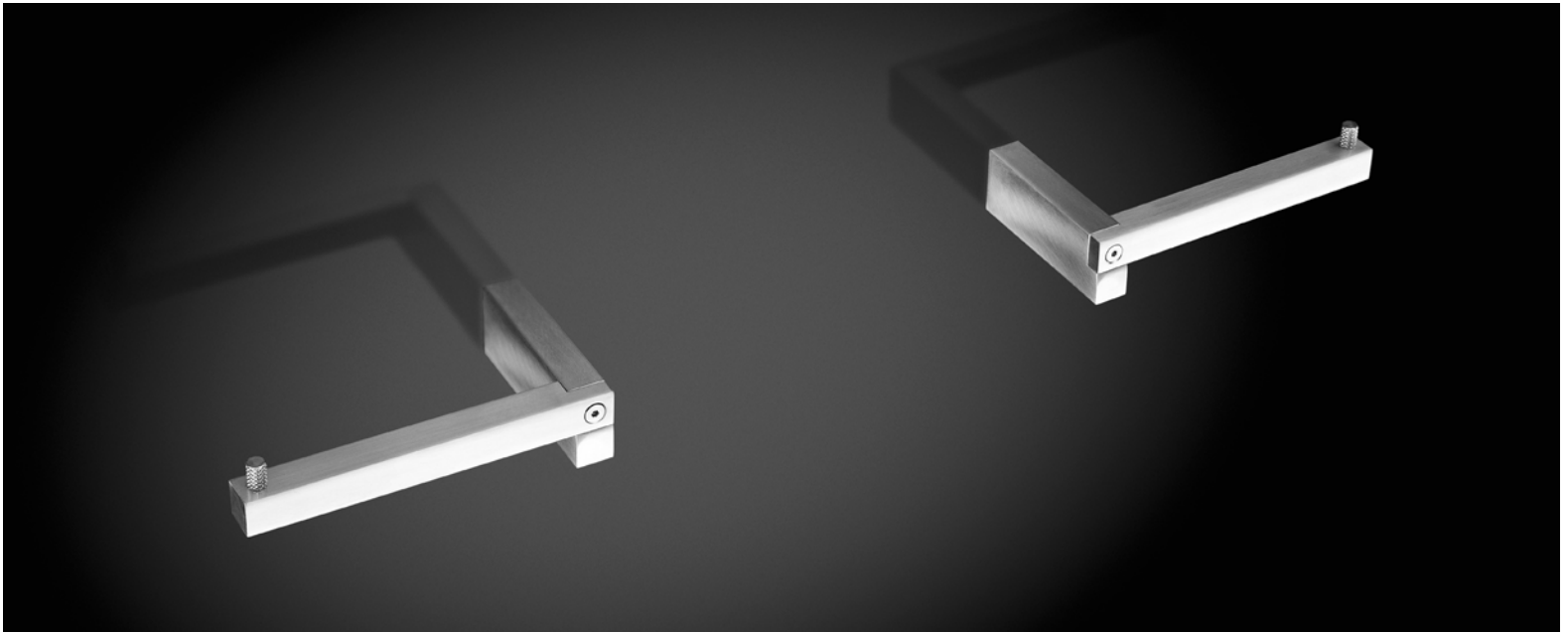



Bicchiere da appoggio in resina bianca.

*White resin cup.*



H	P	Ø	art.
12	8	8	JUST1

Porta sapone da appoggio in resina bianca.

*White resin soap dish.*



H	P	L	art.
3	8	12	JUST3

Dispenser sapone liquido da appoggio in resina bianca e acciaio inox satinato AISI 304.

*White resin and satin stainless steel AISI 304 soap dispenser.*



H	P	Ø	art.
19	11	8	JUST4

Porta scopino da appoggio in resina bianca e manico in acciaio inox satinato AISI 304.

*White resin and satin stainless steel AISI 304 toilet brush and holder.*



H	P	Ø	art.
44	8	8	JUST6

Bicchiere in resina bianca con supporto a parete in acciaio inox satinato AISI 304.

*White resin cup with satin stainless steel AISI 304 wall support.*



H	P	Ø	art.
15	11,2	8	JUST11

Dispenser sapone liquido in resina bianca con supporto a parete in acciaio inox satinato AISI 304.

*White resin soap dispenser with satin stainless steel AISI 304 wall support.*



H	P	Ø	art.
22	14,2	8	JUST14

Porta carta o porta salviette a parete, dx o sx reversibile, in acciaio inox satinato AISI 304.

*Satin stainless steel AISI 304 right or left wall mount paper roll holder.*



H	P	L	art.
3	8	14	JUST8

Appendi abiti a parete in acciaio inox satinato AISI 304.

*Satin stainless steel AISI 304 clothes hook.*



H	P	L	art.
3	8	1,5	JUST7

Porta salviette a parete in acciaio inox satinato AISI 304.

*Satin stainless steel AISI 304 wall mount towel rack.*

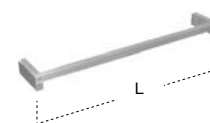

H	P	L	art.
3	8	45	JUST9
		60	JUST19

Piantana porta carta, porta salviette doppio in acciaio inox satinato AISI 304 con porta scopino in resina bianca.

*Freestanding satin stainless steel AISI 304 double paper roll or towel rack with white resin toilet brush and holder.*



H	P	L	art.
60	21,5	33	JUST106

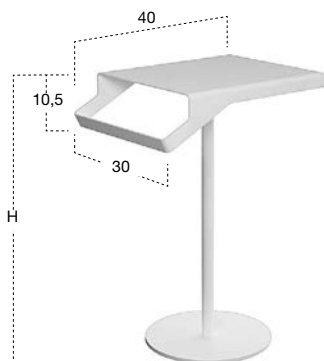

H	P	L	art.
65	40	30	GIN01
75	40	30	GIN02

Tavolino porta oggetti con porta salviette, in acciaio inox AISI 304 verniciato bianco, nero opaco o colorato gofrato come da nostra cartella colori laccati.

*Stainless steel AISI 304 table with towel rail lacquered matt white, black or embossed as per our colour chart.*



COMPLEMENTI E ACCESSORI  
FURNISHINGS - ACCESSORIES

H	Ø	art.
68,5	36	LIN01
78,5	36	LIN02

Tavolino porta oggetti con piano in Cristalplant e piedistallo in acciaio inox AISI 304 verniciato bianco o colorato gofrato come da nostra cartella colori laccati.

Table for objects with a Cristalplant surface and stainless steel AISI 304 base lacquered matt white or embossed as per our colour chart.

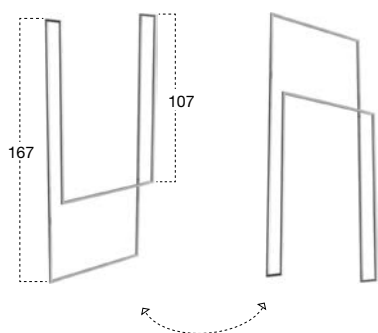

H	P	L	art.
167	15	72	TANDEM-UP

Porta salviette doppio da terra o da soffitto con struttura tubolare 15 x 15 mm in acciaio inox satinato AISI 304.

*Double towel rack freestanding or hanging with 15 x 15 mm satin stainless steel AISI 304 tubular structure.*





H	P	L	art.
80	15	54	TANDEMSA
80	15	54	TANDEMLU

Porta salviette doppio da terra con struttura tubolare 15 x 15 mm in acciaio inox AISI 304 satinato o lucido.

*Double freestanding towel rack with 15 x 15 mm satin or polished stainless steel AISI 304 tubular structure.*

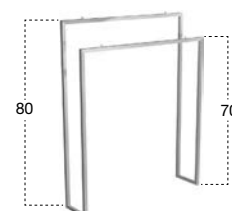



H	L	art.
8,3	2,5	BILLO

Appendi abiti singolo in acciaio inox satinato AISI 304 per vetri box doccia.

*Single clothes hook in satin stainless steel AISI 304 suitable for shower enclosures.*



H	P	L	art.
4,6	32	36	TAO

Seggetta reclinabile con fissaggio a parete in acciaio inox lucido AISI 304 e seduta di colore bianco in poliuretano morbido.

*Reclinable white soft polyurethane seat with polished stainless steel AISI 304 wall supports.*

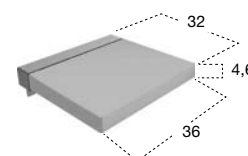



TAPPETI  
*CARPETS*

# GEOMETRIE VOLANTI

\_2018

design  
Paola  
Pastorini



ART. GV520

Per la disponibilità dei tappeti, consultare la pagina dedicata sul nostro sito  
[www.antoniolupi.it](http://www.antoniolupi.it)

*For the availability of carpets, please consult the designated page on our  
website [www.antoniolupi.it](http://www.antoniolupi.it)*

La nuova collezione di tappeti di antoniolupi è un articolato mondo di segni, geometrie, grafiche, di campiture neutre e tracce sottili che le delimitano, un mondo che spazia attraverso un incontro fra le avanguardie artistiche del primo novecento e la corrente della minimal art della fine degli anni 60 reinterpretandole in modo contemporaneo e moderno. Alcune delle matrici formali sono la geometria, il rigore, l'assenza di decorazione, una sintesi tra forma volume e colore, dove si tiene conto delle nozioni di spazio e ordine. GEOMETRIE VOLANTI è una collezione di tappeti che porta il mondo dell'arte a dialogare con gli arredi e conferisce all'ambiente bagno una vera e propria dimensione abitativa donandogli un'aurea elegante e ricercata. Tutti i tappeti proposti da antoniolupi sono realizzati con velluto stampato con tecnica TUFTING.

*The new carpet collection by antoniolupi is an articulated world of signs, geometries, graphics, neutral textures and subtle traces that delimit them, which spans through an encounter between the artistic avant-gardes of the early twentieth century and the current of minimal art of the late 60s reinterpreting them in a contemporary and modern way. Some of the formal matrices are geometry, rigor, the absence of decoration.*

*A synthesis between volume and color, where the notions of space and order are taken into account. GEOMETRIE VOLANTI is a collection of carpets that brings the art world to dialogue with the furnishings, which gives the bathroom a real living dimension, giving it an elegant and refined aura. All the carpets proposed by antoniolupi are made with printed velvet with TUFTING technique.*

ART. GV329



ART. GV628







ART. GV626



ART. GV625



ART. GV336





ART. GV236



ART. GV233



ART. GV340



ART. GV57



ART. GV55





ART. GV330



ART. GV516



ART. GV334



ART. GV510

GEOMETRIE VOLANTI

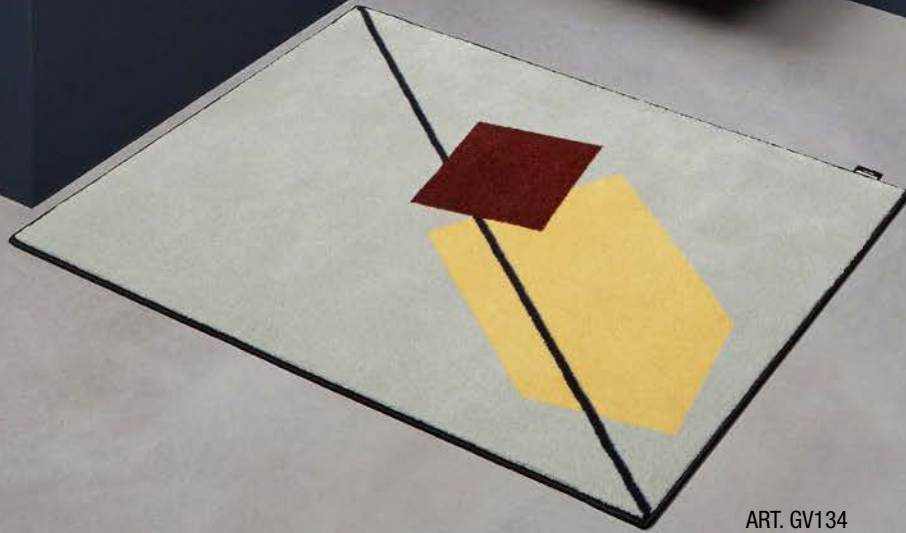

ART. GV134



ART. GV46



ART. GV129



ART. GV49



ART. GV59

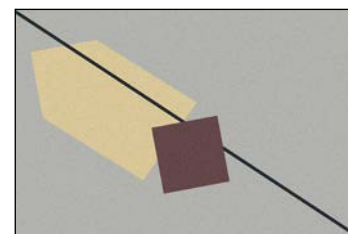

L	P	ART.
120	80	GV134
198	132	GV234
300	200	GV334

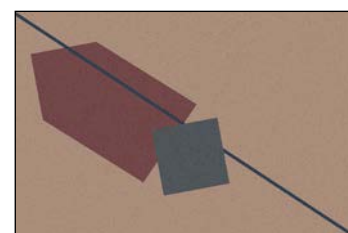

L	P	ART.
120	80	GV129
198	132	GV229
300	200	GV329



L	P	ART.
120	80	GV130
198	132	GV230
300	200	GV330

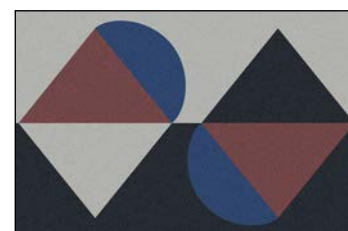

L	P	ART.
120	80	GV131
198	132	GV231
300	200	GV331

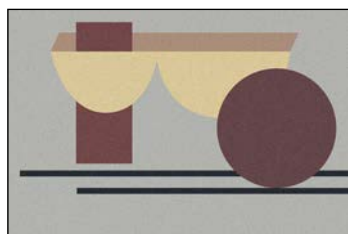

L	P	ART.
120	80	GV132
198	132	GV232
300	200	GV332

---

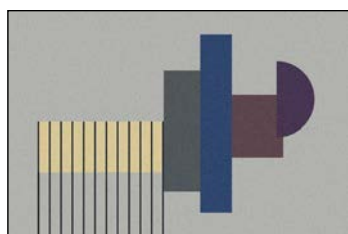

L	P	ART.
120	80	GV137
198	132	GV237
300	200	GV337

---

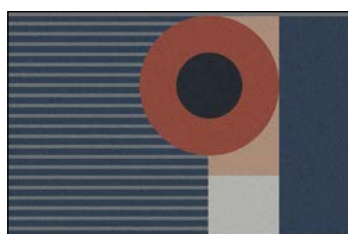

L	P	ART.
120	80	GV136
198	132	GV236
300	200	GV336

---



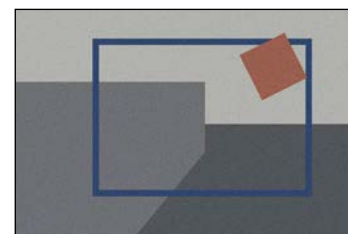

L	P	ART.
120	80	GV133
198	132	GV233
300	200	GV333

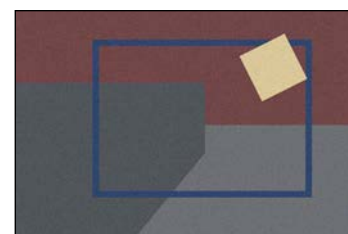

L	P	ART.
120	80	GV139
198	132	GV239
300	200	GV339



L	P	ART.
120	80	GV140
198	132	GV240
300	200	GV340

GEOMETRIE VOLANTI

---



L	P	ART.
160	80	GV43

---



L	P	ART.
400	100	GV53

---

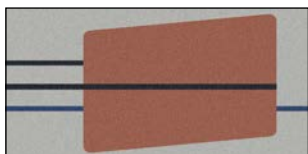

L	P	ART.
160	80	GV44

---

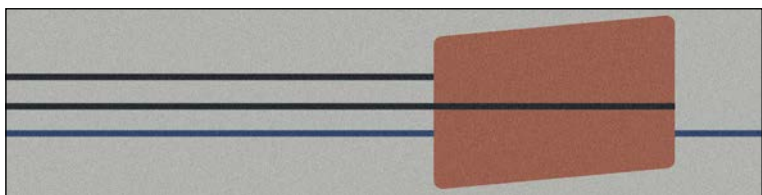

L	P	ART.
400	100	GV54

---



L	P	ART.
160	80	GV45



L	P	ART.
400	100	GV55



L	P	ART.
160	80	GV47

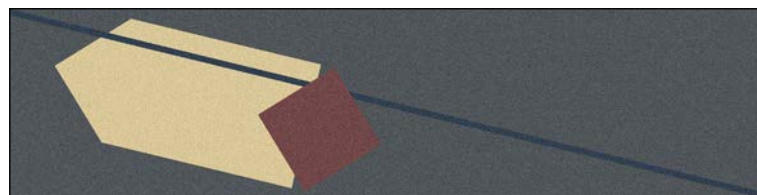

L	P	ART.
400	100	GV57

GEOMETRIE VOLANTI

---



---

L	P	ART.
160	80	GV42

---

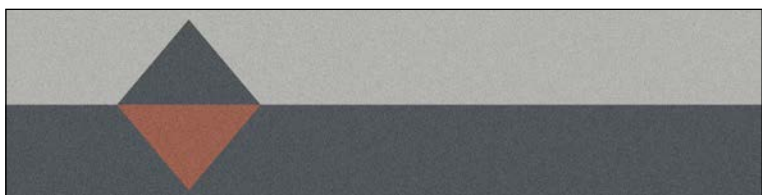

---

L	P	ART.
400	100	GV52

---



---

L	P	ART.
160	80	GV46

---



---

L	P	ART.
400	100	GV56

---

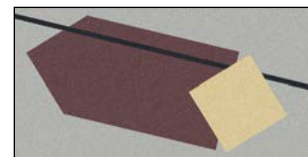

L	P	ART.
160	80	GV48

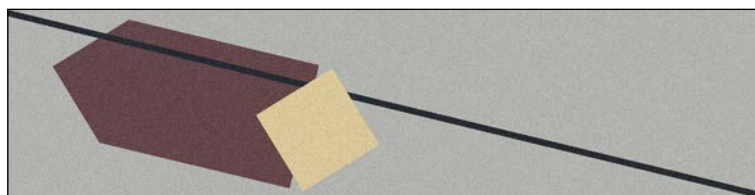

L	P	ART.
400	100	GV58



L	P	ART.
160	80	GV416

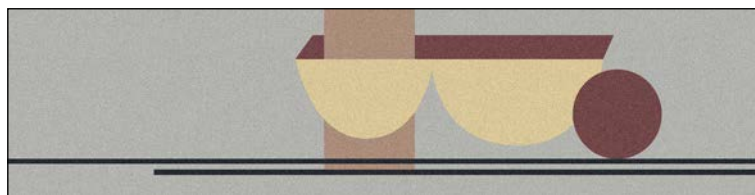

L	P	ART.
4700	100	GV516

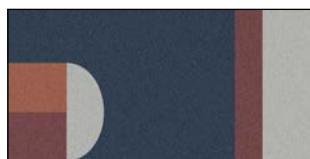

L	P	ART.
160	80	GV414

---



L	P	ART.
400	100	GV514

---

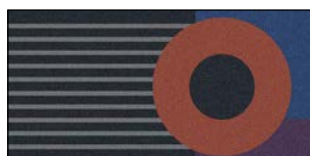

L	P	ART.
160	80	GV415

---



L	P	ART.
400	100	GV515

---



---

L	P	ART.
160	80	GV410

---



---

L	P	ART.
400	100	GV510

---



---

L	P	ART.
160	80	GV49

---



---

L	P	ART.
400	100	GV59

---

# GEOMETRIE VOLANTI

---



L	P	ART.
160	80	GV420

---



L	P	ART.
400	100	GV520

---

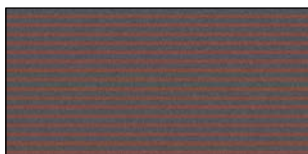

L	P	ART.
160	80	GV421

---

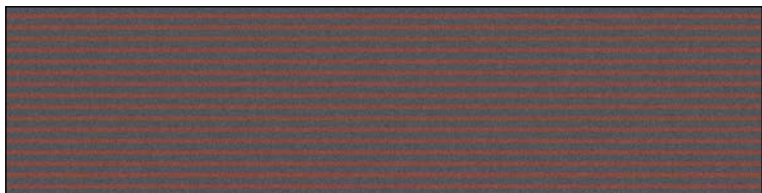

L	P	ART.
400	100	GV521

---



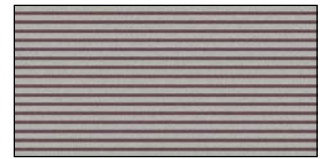

L	P	ART.
160	80	GV422

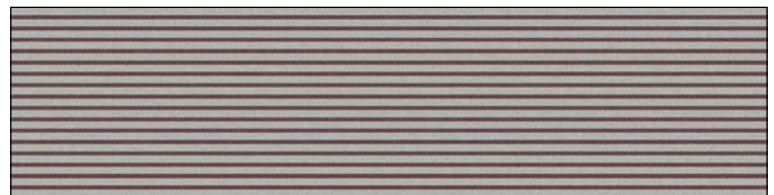

L	P	ART.
400	100	GV522



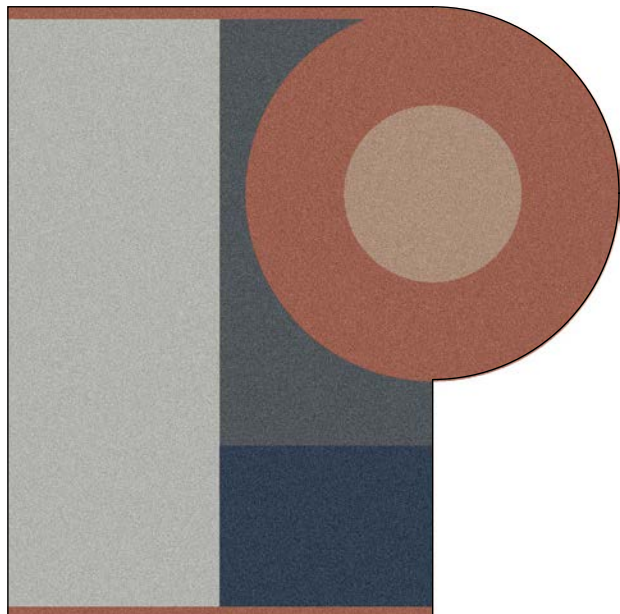

---

L	P	ART.
200	200	GV623

---



---

L	P	ART.
200	200	GV624

---

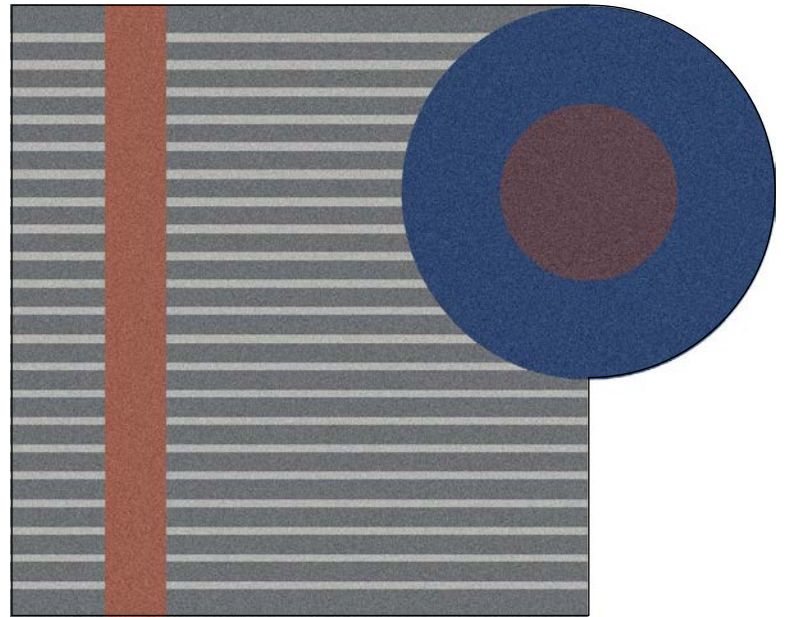

L	P	ART.
250	200	GV625

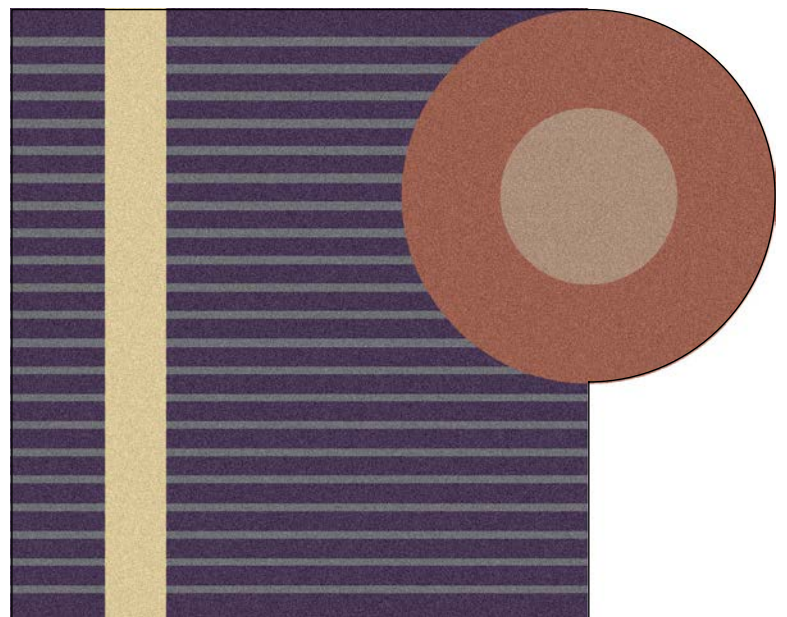

L	P	ART.
250	200	GV626

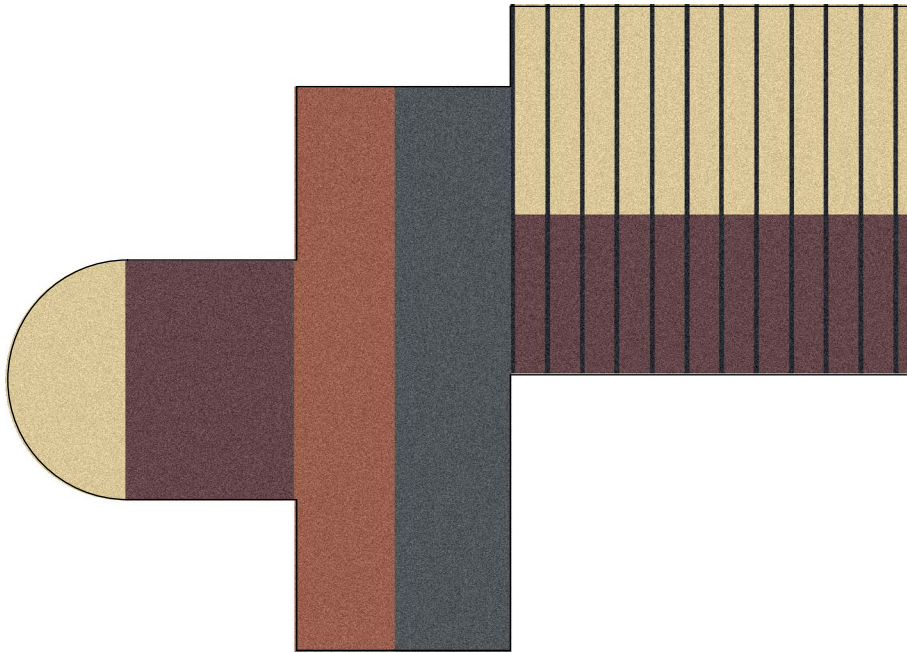

---

L	P	ART.
350	250	GV627

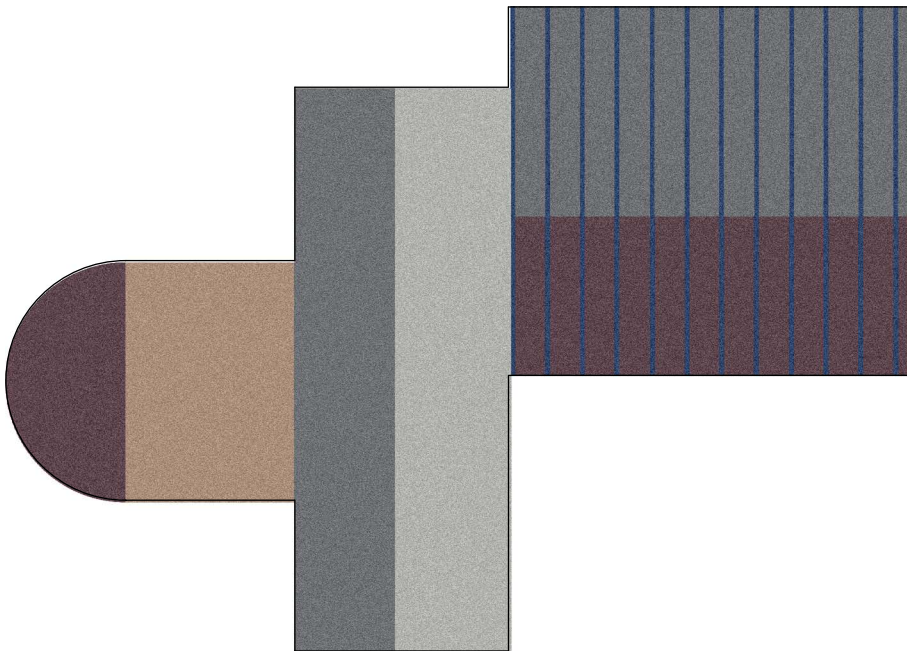

---

L	P	ART.
350	250	GV628





Scarica l'App su App Store e Google Play per entrare nel mondo antoniolupi

*Download the App on App Store and Google Play to discover the world of antoniolupi*

**www.antoniolupi.it**

Per essere costantemente informati su novità e prodotti in modo dettagliato, vi invitiamo a navigare nel nostro sito sempre aggiornato. Nell'area download potrete scaricare tutto il materiale tecnico ed informativo che vi necessita.

*To constantly be up to date in a detailed manner on novelties and products please navigate through our website. In the download area you can find all the necessary technical information.*



Prodotto interamente in Italia.

*Entirely made in Italy.*

© Antonio Lupi Design S.p.A. 2019

NOTA: alla Antonio Lupi Design S.p.A. è riservata la facoltà di apportare ai propri modelli qualsiasi modifica estetica, tecnica, nelle dimensioni e nei colori, ritenuta necessaria, nonché la facoltà di sospendere la produzione in qualunque momento senza preavviso, rinunziata fin d'ora da parte del committente ogni conseguente richiesta risarcitoria. Si declina ogni responsabilità relativa ad eventuali inesattezze contenute in questo catalogo, se dovute ad errori di stampa o trascrizioni. Nessun contenuto di questo catalogo può essere copiato, riprodotto anche parzialmente, ripubblicato, trasmesso o distribuito in qualunque forma, senza autorizzazione scritta dell'Antonio Lupi Design S.p.a.

*NOTE: Antonio Lupi Design S.p.A. reserves the right to make any and all necessary esthetic, technical, colour or size modifications in order to enhance use and esthetic value, and may suspend the production cycle at any moment without notice. Such instances may not be subject to claim by the client. We decline all responsibilities for any possible uncertainties due to misprints in this catalogue. None of the material in this catalogue can be copied, reproduced, republished or distributed in any or partial way unless a written authorization is given from the company Antonio Lupi Design S.p.a.*

**antoniolupi**

**73**

VIA MAZZINI

**75**

Antonio Lupi Design S.p.A.  
via Mazzini 73/75 - 50050 Stabbia  
Cerreto Guidi (Firenze) - Italy  
T +39 0571 586881\_95651  
F +39 0571 586885  
[www.antoniolupi.it](http://www.antoniolupi.it)  
[lupi@antoniolupi.it](mailto:lupi@antoniolupi.it)

