

Sales Presentation Kitchen

Iserlohn, January 2019
Global Marketing

Contents

- Connectivity
- Kitchen sinks
 - Glazed steel kitchen sinks
 - Polished stainless-steel kitchen sinks
- Kitchen side spray
- Soap dispenser
- Dark Platinum matt
- Single-lever mixer Profi
- Dark Finishes

Connectivity



Connectivity



Background information

Connected Kitchen

- Is the answer to the megatrend of digitalisation and the symbiosis of the Dornbracht competences functionality and connectivity
- Is the first electronic product solution for the kitchen
- Makes it possible to be connected to other devices

Sales targets

- Differentiation from the competition

Target groups

- Advanced + Top premium consumer, Architects, Interior Designer, Kitchen planner

Segments

- Private kitchen
- Project business Condominium

Timing

First presentation: Salone del Mobile 2018

Availability: with immediate effect

Use cases



Preparing

Voice control, e.g.:
“Google, wash salad.”
→ Automatic filling of the kitchen sink with the right temperature and volume

Cooking

Display control for precise measurements of water volume and temperature at the touch of a button

Cleaning

Hands-free control via foot sensor
→ When the foot sensor is activated, exactly the right amount of water is dispensed

Connectivity



Product range



eUnit Kitchen Electronic functional unit

Art.-No.
41 271 875

Product range



eUnit Kitchen
Electronic functional unit

Art.-No.
41 270 875



eUnit Kitchen
Electronic functional unit

Art.-No.
41 270 680



eUnit Kitchen
Electronic functional unit

Art.-No.
41 270 790

Product range – required miscellaneous



Dornbracht enables the voice control function in connection with the Smart Home platform from digitalSTROM. Like all Dornbracht digital products, Connected Kitchen has an open IP interface. Once connected to digitalSTROM, the open interface allows voice command devices such as Google Home or Amazon Alexa to be seamlessly integrated. Personal settings can also be programmed individually with Dornbracht's in-house application, SMART WATER.

Additional needed solutions for Showcase Bundle:

- digitalSTROM Hub dS-IP : 79€ market price, digitalSTROM
- Available in DAT, CH, Netherlands
- Rest of the world: on request

Google Home or Amazon Echo voice assistance with digitalSTROM skill

Marketing Tools



Dornbracht Kitchen



Price list 2019

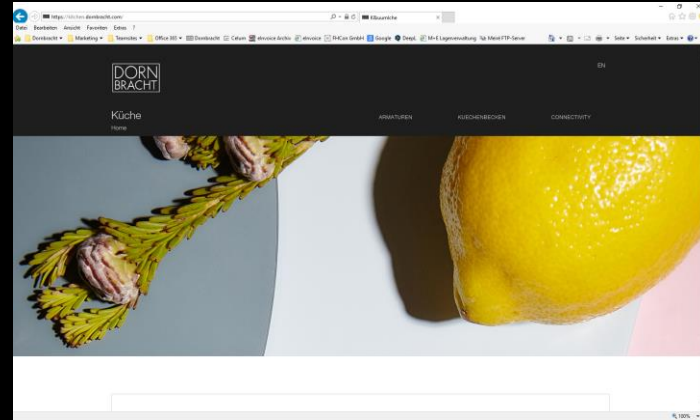

kitchen.dornbracht.com

Kitchen sinks

Portfolio overview

Coloured kitchen sinks



Glazed steel kitchen sinks
Alape

Stainless-steel kitchen sinks



Polished stainless-steel kitchen sinks
SUTER
Linea | Design | Technik



Brushed stainless-steel kitchen sinks
JULIEN

**DORN
BRACHT**

Glazed steel kitchen sinks

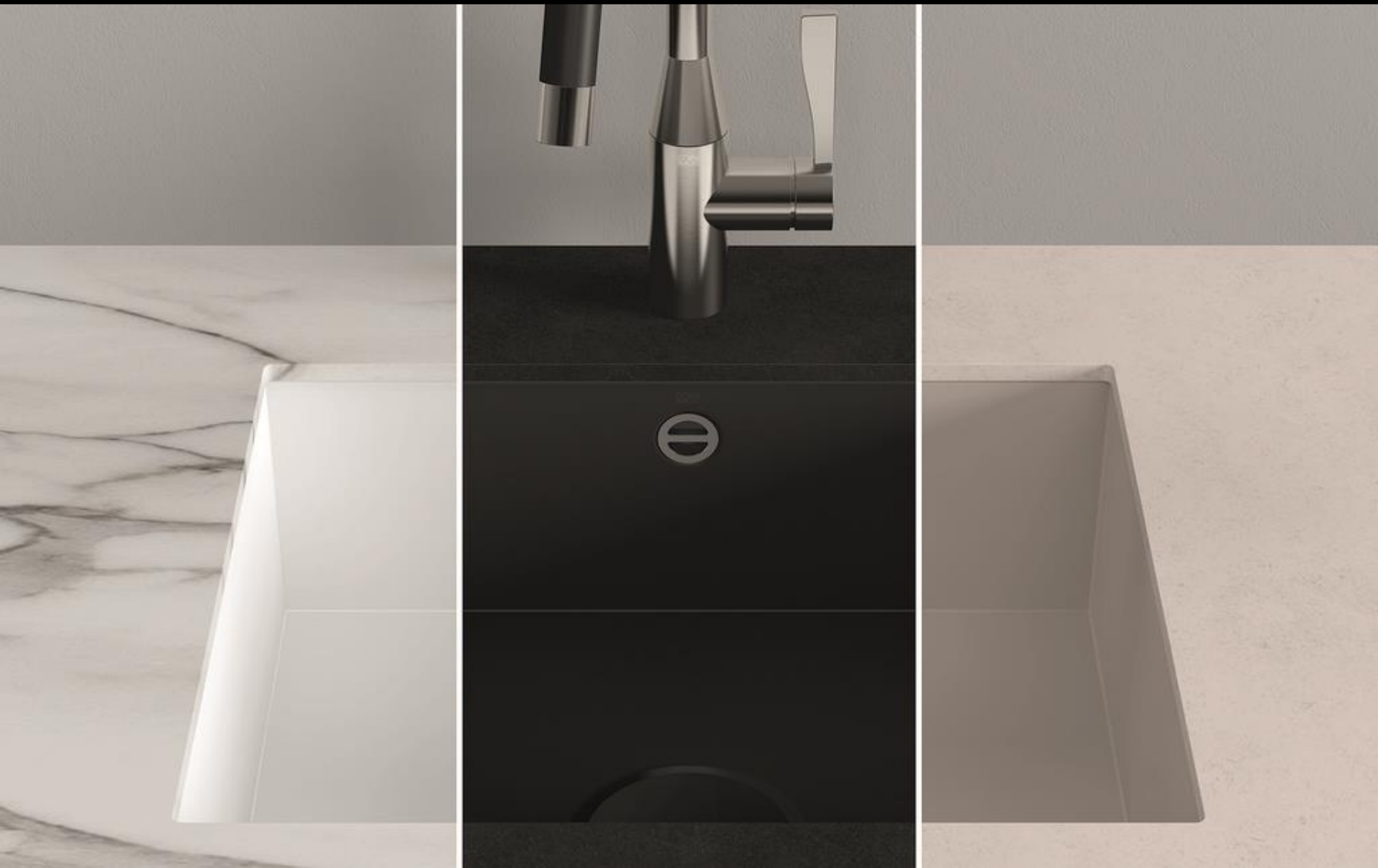

Glazed steel kitchen sinks



Background information

- Colour accents are finding their way into kitchen architecture. This also applies to the variety of materials and colours in the area of worktops.
- Currently no product range of enamelled kitchen sinks in the market = unique position
- Alape has been successful with kitchen sinks in the past. Technology has developed significantly since and "flake off" is no longer a problem.



Sales targets

- Increased sales in the kitchen studios is the basis for the development of the premium fittings business (increase relevance)
- Differentiation from competition
- Expand competence water point

Target groups

- Advanced + Top premium consumer, Architects, Interior Designer, Kitchen planner

Segments

- Private kitchen
- Project business Condominium

Timing

First presentation: Küchenmeile 2017

Availability: May 2018



Harmony



Contrast



Complementary



Glazed steel kitchen sinks



Product range

matt white



matt sand



matt black



Single sink

Art.-No. (with finish)

38 400 002-62 (400 x 400 mm)
38 450 002-62 (450 x 400 mm)
38 500 002-62 (500 x 400 mm)
38 550 002-62 (550 x 400 mm)

Single sink

Art.-No. (with finish)

38 400 002-72 (400 x 400 mm)
38 450 002-72 (450 x 400 mm)
38 500 002-72 (500 x 400 mm)
38 550 002-72 (550 x 400 mm)

Single sink

Art.-No. (with finish)

38 400 002-71 (400 x 400 mm)
38 450 002-71 (450 x 400 mm)
38 500 002-71 (500 x 400 mm)
38 550 002-71 (550 x 400 mm)

Product range

high-gloss white



high-gloss sand



high-gloss black



Single sink

Art.-No. (with finish)

38 400 002-73 (400 x 400 mm)

38 450 002-73 (450 x 400 mm)

38 500 002-73 (500 x 400 mm)

38 550 002-73 (550 x 400 mm)

Single sink

Art.-No. (with finish)

38 400 002-78 (400 x 400 mm)

38 450 002-78 (450 x 400 mm)

38 500 002-78 (500 x 400 mm)

38 550 002-78 (550 x 400 mm)

Single sink

Art.-No. (with finish)

38 400 002-76 (400 x 400 mm)

38 450 002-76 (450 x 400 mm)

38 500 002-76 (500 x 400 mm)

38 550 002-76 (550 x 400 mm)

Marketing Tools



Dornbracht Kitchen



Price list 2019



Flyer*



Colour fan**

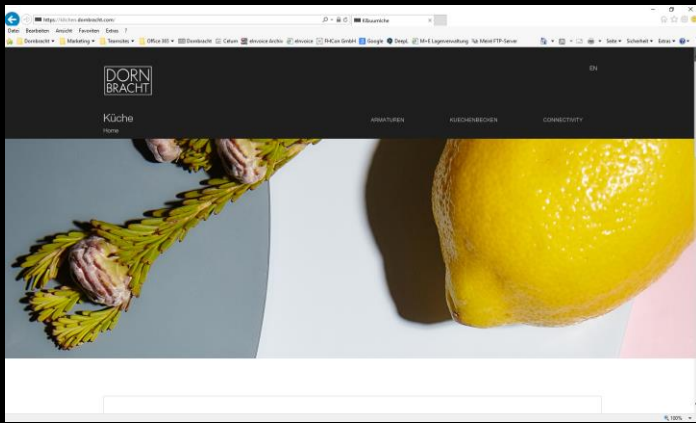

kitchen.dornbracht.com



Advertisement

* only PDF available

** printed version available

Polished stainless-steel kitchen sinks



Polished stainless-steel kitchen sinks



Background information

- Sales of kitchen sinks important for relevance for customers
- Entire portfolio relevance - over 80% of all kitchen purchases for the sink and the fitting come from the same supplier
- Dornbracht is currently not competitive with WATER UNITS due to price and material properties → New basin range starts right here

Sales targets

- Increased sales in the kitchen studios is the basis for the development of the premium fittings business (increase relevance)
- Gain market share

Target groups

- Advanced + Top premium consumer, Architects, Interior Designer, Kitchen planner

Segments

- Private kitchen
- Project business Condominium

Timing

First presentation: Küchenmeile 2018

Availability: May 2018

Polished stainless-steel kitchen sinks



Polished stainless-steel kitchen sinks (video)



Changes

Branding

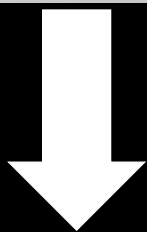

Size of drain valve



Type L
Ø130 mm



Type S
Ø110 mm

Product range



Art.-No. new	replaces Art.-No.	Name
38 180 003-85	38 180 001-85	Single sink
38 340 003-85	38 340 001-85	Single sink
38 400 003-85	38 400 001-85	Single sink
38 450 003-85	38 450 001-85	Single sink
38 500 003-85	38 500 003-85	Single sink
38 550 003-85	38 550 003-85	Single sink
38 650 003-85	38 650 001-85	Single sink
38 501 003-85	38 501 001-85	Single sink
38 551 003-85	38 551 001-85	Single sink
10 400 003-85	10 400 001-85	Pop-up waste and overflow closable by hand
10 405 003-85	10 405 001-85	Pop-up waste and overflow with knob
10 410 003-85	10 410 001-85	Pop-up waste and overflow with electronic control
10 415 003-85	10 415 001-85	Pop-up waste and overflow closable by hand

Marketing Tools



Dornbracht Kitchen



Price list 2019

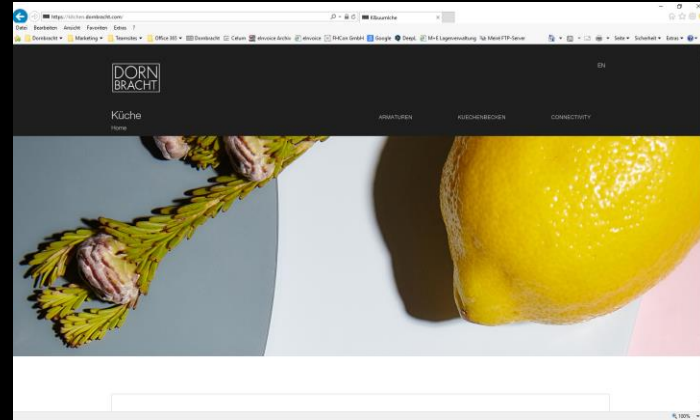

kitchen.dornbracht.com



Advertisement

Kitchen side spray



Kitchen side spray



Background information

- Great importance of functions in the kitchen
- Hardly any competition in Europe, competition in the USA but deficits in design and performance
- New development with focus on function improvement
- Adaptation of design, reduction of the variants from two (lever & knob) to one

Sales targets

- Strengthening of market and competitive position
- Sales increase
- Potential exploitation + differentiating from the competition (US), increasing relevance compared to the competition (EU)

Target groups

- Advanced + Top premium consumer, Architects, Interior Designer, Kitchen planner

Segments

- Private kitchen
- Project business Condominium

Timing

First presentation: Küchenmeile 2017

Availability: July/August 2018

Kitchen side spray

Largest, full-area sprayface
in the market

Excellent handling and usability
due to operation on the front of
the spray (optimised weight)

maintenance-free

Service Concept prepared
with Customer Service

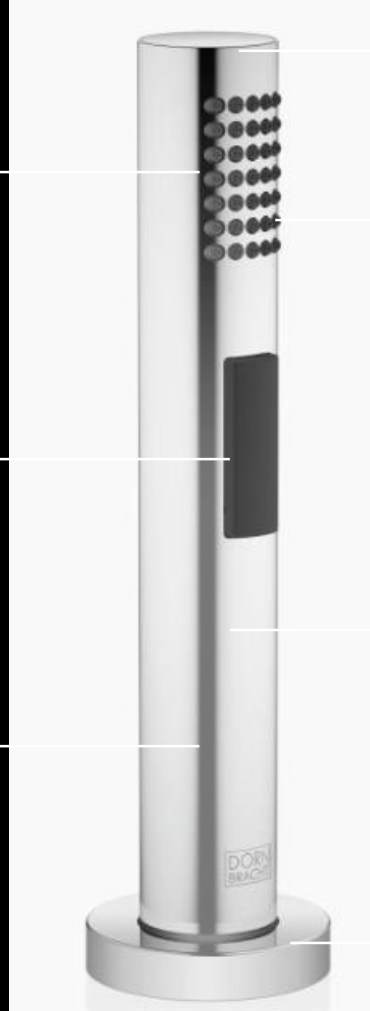

New product design
(minimalistic form,
integrated sprayface)

Technically optimised concept
(reduction of the residual water
volume, robust and resistant
because of simple water ways,
functionally stable)

Comprehensive design to fit
all Dornbracht kitchen mixers
(combination variety)

available with round
or angular rosette

Kitchen side spray



Product range



Rinsing spray set (with round rosette)

Art.-No. new
27 721 970-FF

replaces Art.-No.
27 719 970-FF, 27 718 970-FF



Rinsing spray set (with angular rosette)

Art.-No. new
27 722 970-FF

replaces Art.-No.
27 714 970-FF

Marketing Tools



Dornbracht Kitchen

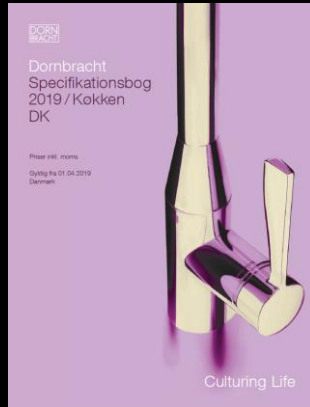

Price list 2019

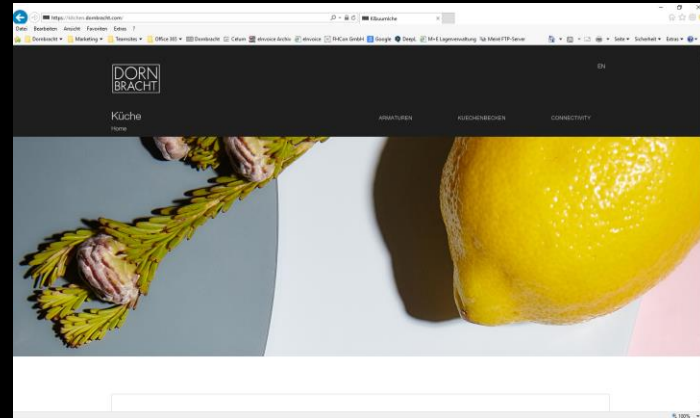

kitchen.dornbracht.com

Soap dispenser



Soap dispenser



Background information

- In recent years, soap dispensers have increased quality problems (Feedback US) → increased customer dissatisfaction
- Functional optimization with consistent design

Sales targets

- Sales increase
- Increase of customer satisfaction and reduction of complaints

Target groups

- Advanced + Top premium consumer, Architects, Interior Designer, Kitchen planner

Segments

- Private kitchen
- Project business Condominium

Timing

Availability: May/June 2018

Soap dispenser

Focus on function optimisation; no design refinement

Enlarged drill hole to prevent blockage of soap

→ Ø2,8 (instead of Ø1,5 / Ø1,6)

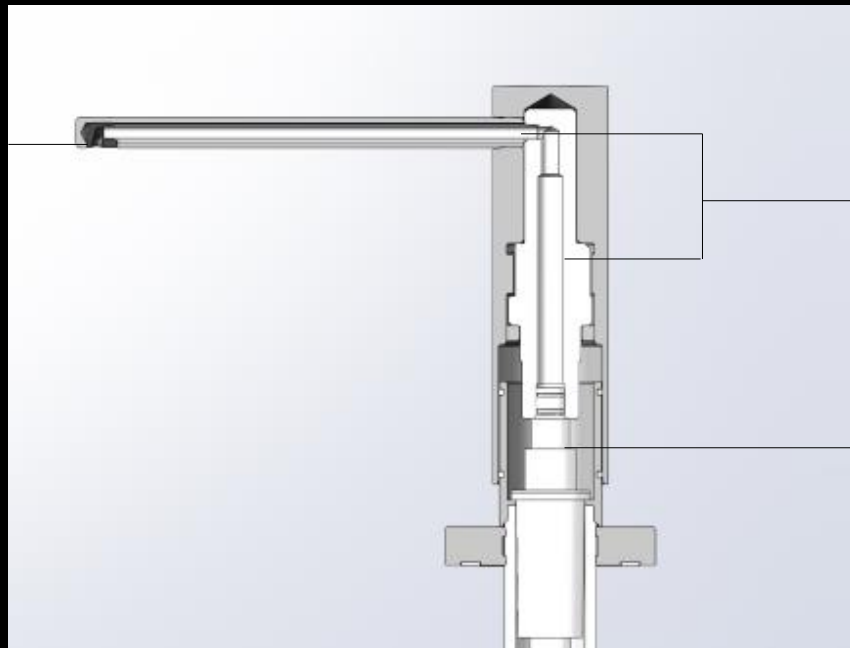

Inner lining to prevent chemical reaction

→ No contact of soap with any brass surface

New pump with a better performance

→ Guarantees a longer lifecycle

Product range



Dispenser with rosette (angular)

Art.-No. new	replaces Art.-No.
82 439 970-FF	82 438 970-FF, 82 437 970-FF, 82 427 970-FF

Dispenser with rosette (round)

Art.-No. new	replaces Art.-No.
82 434 970-FF	82 436 970-FF, 82 435 970-FF,

Dispenser without rosette

Art.-No. new	replaces Art.-
82 424 970-FF	82 426 970-FF

Marketing Tools



Dornbracht Kitchen



Price list 2019

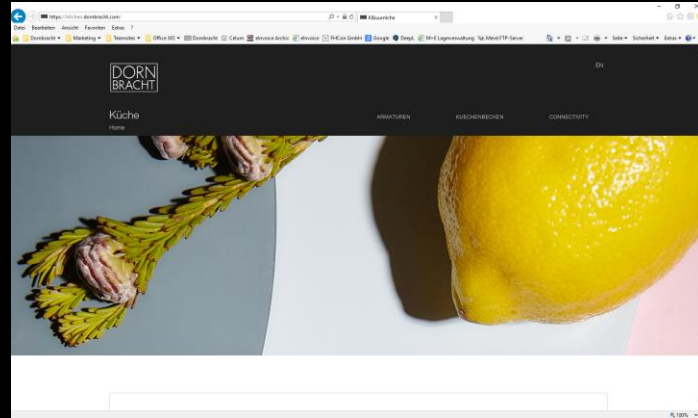

kitchen.dornbracht.com

Single-lever mixer Profi



Single-lever mixer Profi



Background information

- High importance of the topic function in the kitchen
- (Semi-)professional faucets as the most functional product type in the kitchen portfolio
- New development to supplement and revise the existing portfolio: closing the gap between pull-down solutions and Tara Ultra Profi

Sales targets

- Sales increase through expansion of the product range to include variants of the (semi-)professional valve function type
- Strengthening of market and competitive position
 - > EU: Differentiation Competition (Functionality)
 - > Americas: competitive edge

Target groups

- Pure + Advanced Premium consumer, Kitchen planner, Architects, Interior Designer

Segments

- Private kitchen
- Project business Condominium

Timing

Available from: February 2019

Single-lever mixer Profi

Black silicone hose with velvety feel and up to 350 mm radius of action
Heat resistant up to 200°C
Antistatic
Hygienic
UV-resistant
Pivotable spout 360°

Simple spray extraction through cone holder

2 jet types:
Air-enriched flow and spray flow
The conversion is convenient via switch on the back of the black spray element (reversible).



Outstanding functionality at reduced height and projection
Total height: 450 mm
Projection: 200 mm

Self-retaining, visually concealed spring solution

2 storage points ensure that the hose is pivotable independently from the spray holder

The characteristic features of SYNC are the dynamic design and its conical transitions between the body and spout

Sophisticated design in all metallic surfaces offers design variety

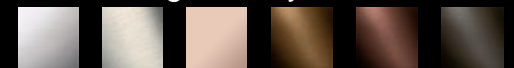

Product range



Single-lever mixer Profi
Chrome

Art.-No. (with finish)
33 865 895-00



Single-lever mixer Profi
Platinum matt

Art.-No. (with finish)
33 865 895-06

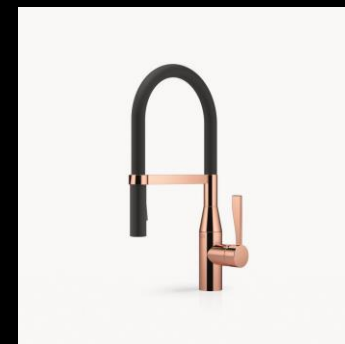

Single-lever mixer Profi
Cyprum

Art.-No. (with finish)
33 865 895-49



Single-lever mixer Profi
Dark Platinum matt

Art.-No. (with finish)
33 865 895-99

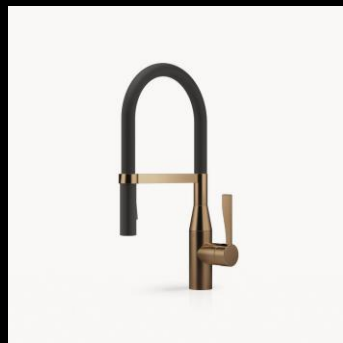

Single-lever mixer Profi
Dark Brass matt

Art.-No. (with finish)
33 865 895-16

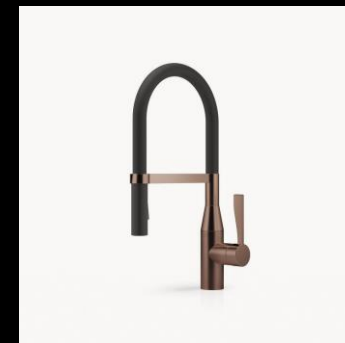

Single-lever mixer Profi
Dark Bronze matt

Art.-No. (with finish)
33 865 895-17

Marketing Tools



Dornbracht Kitchen



Price list 2019

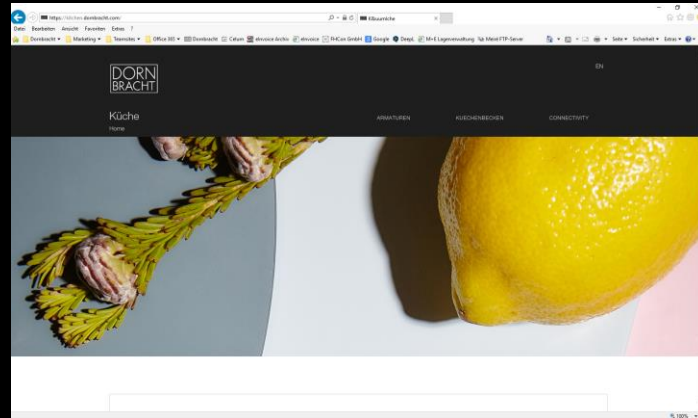

kitchen.dornbracht.com

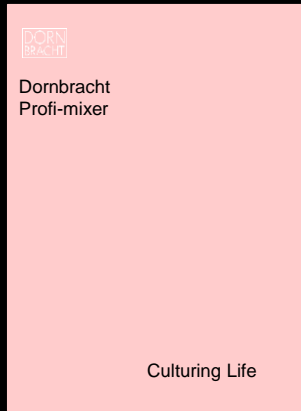

Flyer (tbd)



Social Media



Press



Advertisement

Dark Finishes



Dark Finishes

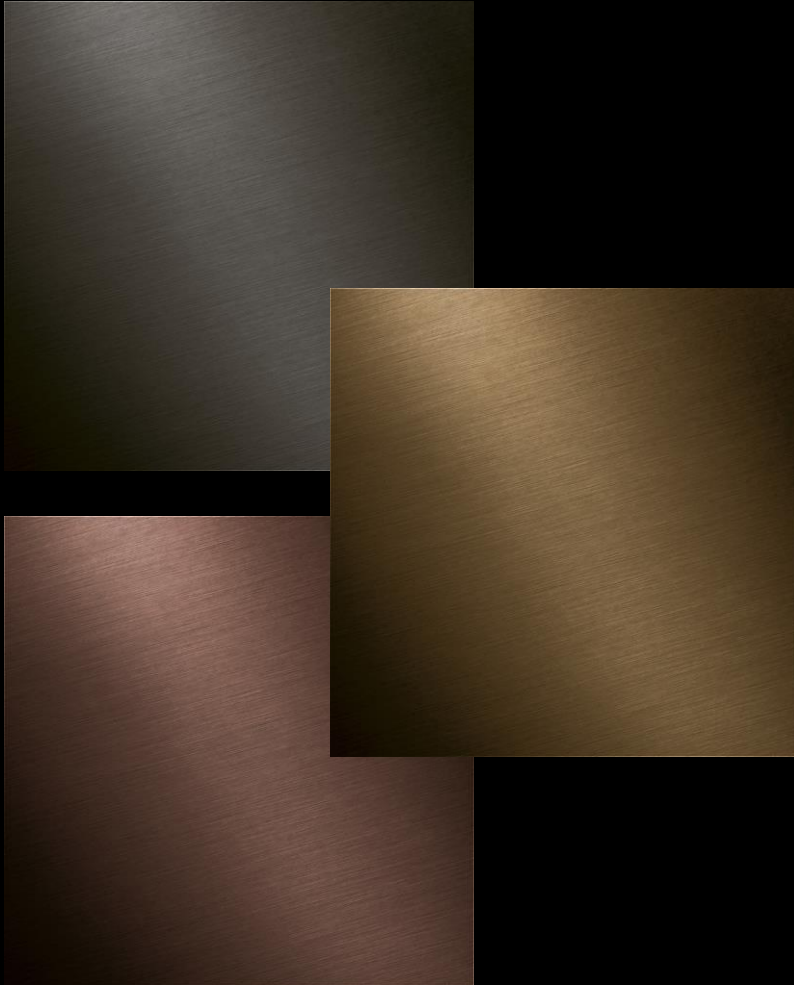

Background information

- Growing demand for new surfaces, materials and structures Kitchen is no longer only a workplace but a place of common life and hospitality -> Trend: Open-plan kitchens
- Most Kitchen competitors in Europe (e.g. Blanco, Franke) do not offer a corresponding dark finish yet

Sales targets

- Pioneering role in the competitive environment Kitchen EU
- Catching up in the market environment AMERICAS
- Generate additional sales

Target groups

- Advanced + Top Premium consumer, Kitchen planner, Architects, Interior Designer

Segments

- Private kitchen
- Project business Condominium

Timing

First presentation: Küchenmeile 2018

Available from: July/August 2019

Dark Finishes



Product range

Dark Platinum matt



Sync



Lot



Tara Ultra



Tara Classic



Generic

Dark Brass/Bronze matt



Sync



Meta.02



Tara Ultra



Tara Classic



Generic

Overview Marketing Tools



Dornbracht Kitchen



Price list 2019

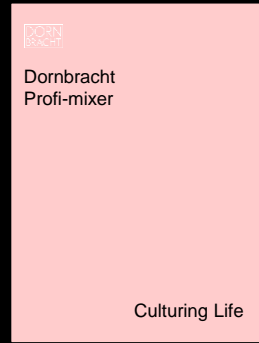

Flyer (tbd)

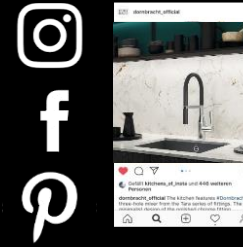

Social Media



Advertisement



E-Mail/LinkedIn banner

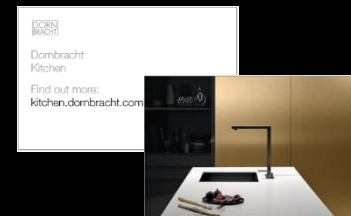

Kitchen Card

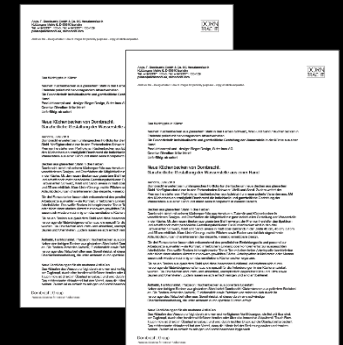

Press



More information on:
kitchen.dornbracht.com

Dornbracht Group
Premium Solutions for Interior Architecture